



## **Cisco TransportPlanner DWDM Operations Guide**

Software Release 8.5

October 18, 2007

### **Americas Headquarters**

Cisco Systems, Inc.  
170 West Tasman Drive  
San Jose, CA 95134-1706  
USA  
<http://www.cisco.com>  
Tel: 408 526-4000  
800 553-NETS (6387)  
Fax: 408 527-0883

Text Part Number: 78-18129-01

THE SPECIFICATIONS AND INFORMATION REGARDING THE PRODUCTS IN THIS MANUAL ARE SUBJECT TO CHANGE WITHOUT NOTICE. ALL STATEMENTS, INFORMATION, AND RECOMMENDATIONS IN THIS MANUAL ARE BELIEVED TO BE ACCURATE BUT ARE PRESENTED WITHOUT WARRANTY OF ANY KIND, EXPRESS OR IMPLIED. USERS MUST TAKE FULL RESPONSIBILITY FOR THEIR APPLICATION OF ANY PRODUCTS.

THE SOFTWARE LICENSE AND LIMITED WARRANTY FOR THE ACCOMPANYING PRODUCT ARE SET FORTH IN THE INFORMATION PACKET THAT SHIPPED WITH THE PRODUCT AND ARE INCORPORATED HEREIN BY THIS REFERENCE. IF YOU ARE UNABLE TO LOCATE THE SOFTWARE LICENSE OR LIMITED WARRANTY, CONTACT YOUR CISCO REPRESENTATIVE FOR A COPY.

The following information is for FCC compliance of Class A devices: This equipment has been tested and found to comply with the limits for a Class A digital device, pursuant to part 15 of the FCC rules. These limits are designed to provide reasonable protection against harmful interference when the equipment is operated in a commercial environment. This equipment generates, uses, and can radiate radio-frequency energy and, if not installed and used in accordance with the instruction manual, may cause harmful interference to radio communications. Operation of this equipment in a residential area is likely to cause harmful interference, in which case users will be required to correct the interference at their own expense.

The following information is for FCC compliance of Class B devices: The equipment described in this manual generates and may radiate radio-frequency energy. If it is not installed in accordance with Cisco's installation instructions, it may cause interference with radio and television reception. This equipment has been tested and found to comply with the limits for a Class B digital device in accordance with the specifications in part 15 of the FCC rules. These specifications are designed to provide reasonable protection against such interference in a residential installation. However, there is no guarantee that interference will not occur in a particular installation.

Modifying the equipment without Cisco's written authorization may result in the equipment no longer complying with FCC requirements for Class A or Class B digital devices. In that event, your right to use the equipment may be limited by FCC regulations, and you may be required to correct any interference to radio or television communications at your own expense.

You can determine whether your equipment is causing interference by turning it off. If the interference stops, it was probably caused by the Cisco equipment or one of its peripheral devices. If the equipment causes interference to radio or television reception, try to correct the interference by using one or more of the following measures:

- Turn the television or radio antenna until the interference stops.
- Move the equipment to one side or the other of the television or radio.
- Move the equipment farther away from the television or radio.
- Plug the equipment into an outlet that is on a different circuit from the television or radio. (That is, make certain the equipment and the television or radio are on circuits controlled by different circuit breakers or fuses.)

Modifications to this product not authorized by Cisco Systems, Inc. could void the FCC approval and negate your authority to operate the product.

The Cisco implementation of TCP header compression is an adaptation of a program developed by the University of California, Berkeley (UCB) as part of UCB's public domain version of the UNIX operating system. All rights reserved. Copyright © 1981, Regents of the University of California.

NOTWITHSTANDING ANY OTHER WARRANTY HEREIN, ALL DOCUMENT FILES AND SOFTWARE OF THESE SUPPLIERS ARE PROVIDED "AS IS" WITH ALL FAULTS. CISCO AND THE ABOVE-NAMED SUPPLIERS DISCLAIM ALL WARRANTIES, EXPRESSED OR IMPLIED, INCLUDING, WITHOUT LIMITATION, THOSE OF MERCHANTABILITY, FITNESS FOR A PARTICULAR PURPOSE AND NONINFRINGEMENT OR ARISING FROM A COURSE OF DEALING, USAGE, OR TRADE PRACTICE.

IN NO EVENT SHALL CISCO OR ITS SUPPLIERS BE LIABLE FOR ANY INDIRECT, SPECIAL, CONSEQUENTIAL, OR INCIDENTAL DAMAGES, INCLUDING, WITHOUT LIMITATION, LOST PROFITS OR LOSS OR DAMAGE TO DATA ARISING OUT OF THE USE OR INABILITY TO USE THIS MANUAL, EVEN IF CISCO OR ITS SUPPLIERS HAVE BEEN ADVISED OF THE POSSIBILITY OF SUCH DAMAGES.

CCVP, the Cisco logo, and Welcome to the Human Network are trademarks of Cisco Systems, Inc.; Changing the Way We Work, Live, Play, and Learn is a service mark of Cisco Systems, Inc.; and Access Registrar, Aironet, BPX, Catalyst, CCDA, CCDP, CCIE, CCIP, CCNA, CCNP, CCSP, Cisco, the Cisco Certified Internetwork Expert logo, Cisco IOS, Cisco Press, Cisco Systems, Cisco Systems Capital, the Cisco Systems logo, Cisco Unity, Enterprise/Solver, EtherChannel, EtherFast, EtherSwitch, Fast Step, Follow Me Browsing, FormShare, GigaDrive, HomeLink, Internet Quotient, IOS, iPhone, IP/TV, iQ Expertise, the iQ logo, iQ Net Readiness Scorecard, iQuick Study, LightStream, Linksys, MeetingPlace, MGX, Networkers, Networking Academy, Network Registrar, PIX, ProConnect, ScriptShare, SMARTnet, StackWise, The Fastest Way to Increase Your Internet Quotient, and TransPath are registered trademarks of Cisco Systems, Inc. and/or its affiliates in the United States and certain other countries.

All other trademarks mentioned in this document or Website are the property of their respective owners. The use of the word partner does not imply a partnership relationship between Cisco and any other company. (0710R)



## FIGURES

|             |                                                       |      |
|-------------|-------------------------------------------------------|------|
| Figure 1-1  | Cisco TransportPlanner Process Flow                   | 1-6  |
| Figure 1-2  | Project Explorer View                                 | 1-8  |
| Figure 1-3  | Point-to-Point Traffic Demand in the Project Explorer | 1-9  |
| Figure 1-4  | P-Ring Traffic Demand in the Project Explorer         | 1-9  |
| Figure 1-5  | ROADM Traffic Demand in the Project Explorer          | 1-10 |
| Figure 1-6  | Aggregated Ethernet Demand in Project Explorer        | 1-10 |
| Figure 1-7  | TDM Aggregated Demand in Project Explorer             | 1-10 |
| Figure 1-8  | Locked Sites in the Project Explorer View             | 1-11 |
| Figure 2-1  | Cisco TransportPlanner 8.5 Login Dialog Box           | 2-14 |
| Figure 2-2  | Opening a Project from the Tasks Pane                 | 2-15 |
| Figure 2-3  | Unloaded Network in the Project Explorer              | 2-16 |
| Figure 2-4  | Loaded Network in the Project Explorer                | 2-16 |
| Figure 2-5  | Import <R2.5 Project Name> Dialog Box                 | 2-17 |
| Figure 2-6  | Options Explorer Dialog Box                           | 2-19 |
| Figure 2-7  | Duct Details Shown on the NtView Name Tab             | 2-20 |
| Figure 2-8  | Alien Card Dialog Box                                 | 2-26 |
| Figure 2-9  | AlienSoft Dialog Box, Default-OCh Tab                 | 2-27 |
| Figure 2-10 | Interface Operative Area                              | 2-29 |
| Figure 2-11 | Export Dialog Box                                     | 2-31 |
| Figure 2-12 | Import Dialog Box                                     | 2-32 |
| Figure 2-13 | PlugIn Registry Dialog Box                            | 2-33 |
| Figure 2-14 | Project Creation Wizard                               | 2-37 |
| Figure 2-15 | Project Creation Wizard Subnet Page                   | 2-38 |
| Figure 2-16 | Network Creation Wizard Topology Page                 | 2-39 |
| Figure 2-17 | Network Creation Wizard- Site Data Page               | 2-40 |
| Figure 2-18 | Network Creation Wizard Options Page                  | 2-41 |
| Figure 2-19 | Network Creation Wizard Sites Page                    | 2-42 |
| Figure 2-20 | Network Creation Wizard Span Page                     | 2-44 |
| Figure 2-21 | Site Creation Wizard                                  | 2-46 |
| Figure 2-22 | Traffic Subnet Creation Wizard                        | 2-47 |

|             |                                                    |       |
|-------------|----------------------------------------------------|-------|
| Figure 2-23 | Traffic Subnet Builder Wizard                      | 2-48  |
| Figure 2-24 | Point to Point Demand Creation Wizard              | 2-49  |
| Figure 2-25 | Point-to-Point Demand Between Two Sites            | 2-50  |
| Figure 2-26 | P-Ring Creation Wizard                             | 2-51  |
| Figure 2-27 | P-Ring Demand                                      | 2-53  |
| Figure 2-28 | Create ROADM Demand Dialog Box                     | 2-54  |
| Figure 2-29 | Ethernet Aggregation Creation Wizard               | 2-55  |
| Figure 2-30 | EthernetAggr2 Demand Window, DWDM Channel Tab      | 2-57  |
| Figure 2-31 | TDM Aggr Creation Wizard                           | 2-58  |
| Figure 2-32 | TDMAggr Demand                                     | 2-59  |
| Figure 2-33 | Creating Optical Subnet                            | 2-61  |
| Figure 2-34 | Create Optical Subnet Dialog Box                   | 2-61  |
| Figure 2-35 | Summary Tab                                        | 2-64  |
| Figure 2-36 | ANS View Subtab in the Installation Parameters Tab | 2-67  |
| Figure 2-37 | Internal Connections Tab                           | 2-69  |
| Figure 2-38 | Traffic Matrix Tab                                 | 2-71  |
| Figure 2-39 | Query Dialog                                       | 2-73  |
| Figure 2-40 | Layout Report (Rack View)                          | 2-74  |
| Figure 2-41 | Layout Report (Shelf View)                         | 2-75  |
| Figure 2-42 | Power Consumption                                  | 2-77  |
| Figure 2-43 | Link Availability Report                           | 2-78  |
| Figure 2-44 | Optical Results Tab                                | 2-80  |
| Figure 2-45 | Wavelength Routing Tab                             | 2-83  |
| Figure 2-46 | Reports Diff Dialog Box                            | 2-85  |
| Figure 2-47 | BoM Diff Report                                    | 2-86  |
| Figure 2-48 | Installation Parameters Diff Report                | 2-87  |
| Figure 2-49 | Internal Connections Diff Report                   | 2-89  |
| Figure 2-50 | Site in the Project Explorer                       | 2-92  |
| Figure 2-51 | Analyzed Site in the Project Explorer              | 2-93  |
| Figure 2-52 | Select Subnet Dialog Box                           | 2-99  |
| Figure 2-53 | Edit Point to Point Demand Dialog Box              | 2-100 |
| Figure 2-54 | Edit P-Ring Demand Dialog Box                      | 2-101 |
| Figure 2-55 | Edit ROADM Demand Dialog Box                       | 2-102 |
| Figure 2-56 | Ethernet Aggregated Demand Dialog Box              | 2-104 |
| Figure 2-57 | Adding Circuit to a WDM Transport Channel          | 2-105 |

|                    |                                                                |              |
|--------------------|----------------------------------------------------------------|--------------|
| <i>Figure 2-58</i> | Edit Request Dialog Box for an Ethernet WDM Transport Channel  | <b>2-105</b> |
| <i>Figure 2-59</i> | Circuit Path View in a Ethernet Aggregated Demand              | <b>2-107</b> |
| <i>Figure 2-60</i> | Edit Request in a TDM WDM Transport Channel                    | <b>2-108</b> |
| <i>Figure 2-61</i> | TDM Point to point Circuit Creation in a WDM transport channel | <b>2-110</b> |
| <i>Figure 2-62</i> | TDM Circuit in a TDM Aggr Demand                               | <b>2-111</b> |
| <i>Figure 2-63</i> | TDM Aggr Demand Window, Report Tab                             | <b>2-112</b> |
| <i>Figure 2-64</i> | Fibres Dialog                                                  | <b>2-116</b> |
| <i>Figure 2-65</i> | Sites List                                                     | <b>2-118</b> |
| <i>Figure 2-66</i> | Sites Edit Dialog                                              | <b>2-118</b> |
| <i>Figure 2-67</i> | Selecting the Layout View                                      | <b>2-120</b> |
| <i>Figure 2-68</i> | Details Dialog Box                                             | <b>2-121</b> |
| <i>Figure 2-69</i> | Ellipse Shape                                                  | <b>2-123</b> |
| <i>Figure 2-70</i> | Square Shape                                                   | <b>2-124</b> |
| <i>Figure 2-71</i> | Snake Shape                                                    | <b>2-124</b> |
| <i>Figure 2-72</i> | Double Ring Shape                                              | <b>2-125</b> |
| <i>Figure 2-73</i> | Fit to Maximum Rectangle View Shape                            | <b>2-126</b> |
| <i>Figure 2-74</i> | Locked Sites in the Project Explorer View                      | <b>2-130</b> |
| <i>Figure 2-75</i> | Bill of Material Tab, Net View Subtab                          | <b>2-132</b> |
| <i>Figure 2-76</i> | Bill of Material Tab, Site View Subtab                         | <b>2-133</b> |
| <i>Figure 2-77</i> | Bill of Material Tab, Spare Subtab                             | <b>2-135</b> |
| <i>Figure 2-78</i> | Price Manager Dialog Box                                       | <b>2-137</b> |
| <i>Figure 3-1</i>  | Single-Span Topology Example                                   | <b>3-2</b>   |
| <i>Figure 3-2</i>  | Point-to-Point Topology Example                                | <b>3-2</b>   |
| <i>Figure 3-3</i>  | Linear Topology Example                                        | <b>3-2</b>   |
| <i>Figure 3-4</i>  | Hubbed Ring Topology Example                                   | <b>3-3</b>   |
| <i>Figure 3-5</i>  | Meshed Ring Topology Example                                   | <b>3-3</b>   |
| <i>Figure A-1</i>  | Cisco TransportPlanner Window with Network Tree                | <b>A-1</b>   |
| <i>Figure D-1</i>  | Interface Operative Area                                       | <b>D-2</b>   |
| <i>Figure D-2</i>  | Interface Margin Application                                   | <b>D-3</b>   |
| <i>Figure D-3</i>  | Q-Factor Curve                                                 | <b>D-5</b>   |
| <i>Figure D-4</i>  | Generation Block for Single-Interfering Cross-Talk Measurement | <b>D-6</b>   |
| <i>Figure D-5</i>  | Block Diagram for Crosstalk Measure                            | <b>D-6</b>   |
| <i>Figure D-6</i>  | Generation Block for Gaussian Cross-Talk Measurement           | <b>D-7</b>   |



## CONTENTS

|                                                                     |       |
|---------------------------------------------------------------------|-------|
| Revision History                                                    | xvi   |
| Document Objectives                                                 | xvi   |
| Audience                                                            | xvi   |
| Document Organization                                               | xvii  |
| Related Documentation                                               | xvii  |
| Document Conventions                                                | xvii  |
| Obtaining Optical Networking Information                            | xviii |
| Where to Find Safety and Warning Information                        | xix   |
| Cisco Optical Networking Product Documentation CD-ROM               | xix   |
| Obtaining Documentation, Obtaining Support, and Security Guidelines | xix   |

---

### CHAPTER 1

#### Overview 1-1

|                                                                 |      |
|-----------------------------------------------------------------|------|
| 1.1 Cisco TransportPlanner Features                             | 1-1  |
| 1.2 Network Design Process                                      | 1-2  |
| 1.2.1 Network Design Constraints                                | 1-3  |
| 1.2.2 Platform Support                                          | 1-3  |
| 1.2.3 Topology Support                                          | 1-3  |
| 1.2.4 Protection Scheme Support                                 | 1-4  |
| 1.2.5 Service Support                                           | 1-4  |
| 1.3 Cisco TransportPlanner Process Flow                         | 1-5  |
| 1.4 Planning Traffic in Cisco TransportPlanner                  | 1-7  |
| 1.5 Cisco TransportPlanner Traffic in the Project Explorer Pane | 1-8  |
| 1.5.1 Point-to-Point Traffic Demands                            | 1-9  |
| 1.5.2 P-Ring Traffic Demands                                    | 1-9  |
| 1.5.3 ROADM Traffic Demands                                     | 1-9  |
| 1.5.4 Aggregated Ethernet Demand                                | 1-10 |
| 1.5.5 TDM Aggregated Demand                                     | 1-10 |
| 1.6 Auto, Forced, and Locked Parameters                         | 1-11 |

---

### CHAPTER 2

#### Designing Networks with Cisco TransportPlanner 2-13

|                                      |      |
|--------------------------------------|------|
| 2.1 Launching Cisco TransportPlanner | 2-14 |
| 2.1.1 Opening a Project              | 2-15 |

|        |                                                        |      |
|--------|--------------------------------------------------------|------|
| 2.1.2  | Loading and Unloading Networks                         | 2-15 |
| 2.1.3  | Saving a Project                                       | 2-16 |
| 2.1.4  | Importing a Cisco TransportPlanner Release 2.5 Project | 2-16 |
| 2.1.5  | Closing a Project                                      | 2-18 |
| 2.2    | Setting Cisco TransportPlanner Options                 | 2-18 |
| 2.2.1  | Setting the Graphical Display                          | 2-18 |
| 2.2.2  | Setting the Default Platform Values                    | 2-20 |
| 2.2.3  | Setting the Default Project Values                     | 2-24 |
| 2.2.4  | Defining Third-Party DWDM Interfaces                   | 2-25 |
| 2.2.5  | Exporting a File                                       | 2-30 |
| 2.2.6  | Importing a File                                       | 2-31 |
| 2.2.7  | Resetting the Default Layout                           | 2-32 |
| 2.2.8  | Adding Plug-ins                                        | 2-33 |
| 2.2.9  | Managing Plug-ins                                      | 2-34 |
| 2.2.10 | Adding User Profiles                                   | 2-35 |
| 2.2.11 | Running a Script                                       | 2-35 |
| 2.2.12 | Refreshing the Script Menu                             | 2-35 |
| 2.2.13 | Understanding Sides Labeling                           | 2-36 |
| 2.3    | Creating a Project                                     | 2-36 |
| 2.3.1  | Adding Sites                                           | 2-45 |
| 2.3.2  | Adding Fiber Spans                                     | 2-46 |
| 2.3.3  | Creating Traffic Subnet                                | 2-47 |
| 2.3.4  | Creating a Point-to-Point Demand                       | 2-48 |
| 2.3.5  | Creating a Protected Ring Demand                       | 2-50 |
| 2.3.6  | Creating a ROADM Demand                                | 2-53 |
| 2.3.7  | Creating Ethernet Aggregated Demand                    | 2-55 |
| 2.3.8  | Creating TDM Aggregated Demand                         | 2-57 |
| 2.3.9  | Adding Notes to a Project                              | 2-60 |
| 2.3.10 | Creating an Optical Subnet                             | 2-60 |
| 2.4    | Analyzing the Network                                  | 2-62 |
| 2.5    | Viewing Network Reports                                | 2-62 |
| 2.5.1  | Viewing the Summary Report                             | 2-63 |
| 2.5.2  | Saving the NE Update File                              | 2-65 |
| 2.5.3  | Viewing the Installation Parameters                    | 2-66 |
| 2.5.4  | Viewing Internal Connections                           | 2-68 |
| 2.5.5  | Viewing the Traffic Matrix Report                      | 2-70 |
| 2.5.6  | Displaying the Layout                                  | 2-74 |
| 2.5.7  | Viewing Power Consumption from the Layout Report       | 2-76 |
| 2.5.8  | Viewing the Link Availability Report                   | 2-77 |

|        |                                                                    |       |
|--------|--------------------------------------------------------------------|-------|
| 2.5.9  | Viewing Optical Results                                            | 2-79  |
| 2.5.10 | Viewing Wavelength Routing                                         | 2-83  |
| 2.5.11 | Viewing Report Differences                                         | 2-84  |
| 2.6    | Editing a Project                                                  | 2-90  |
| 2.6.1  | Editing Project Parameters                                         | 2-91  |
| 2.6.2  | Editing Network Parameters                                         | 2-91  |
| 2.6.3  | Editing Site Parameters                                            | 2-92  |
| 2.6.4  | Editing Service Demand Association and Traffic Subnet              | 2-98  |
| 2.6.5  | Creating a Maintenance Center                                      | 2-99  |
| 2.6.6  | Editing a Point-to-Point Demand                                    | 2-100 |
| 2.6.7  | Editing a P-Ring Demand                                            | 2-101 |
| 2.6.8  | Editing a ROADM Demand                                             | 2-102 |
| 2.6.9  | Editing an Ethernet Aggregated Demand                              | 2-103 |
| 2.6.10 | Editing a TDM Aggregated Demand                                    | 2-108 |
| 2.6.11 | Deleting a Fiber Span                                              | 2-112 |
| 2.6.12 | Deleting a Network                                                 | 2-112 |
| 2.6.13 | Deleting Notes                                                     | 2-112 |
| 2.6.14 | Deleting Sites                                                     | 2-113 |
| 2.6.15 | Deleting a Traffic Demand                                          | 2-113 |
| 2.6.16 | Deleting a Traffic Subnet                                          | 2-113 |
| 2.6.17 | Editing Fiber Span, Pair, and Fiber Parameters                     | 2-114 |
| 2.6.18 | Editing Fiber Spans, Pairs, and Fibers Using the Fibres Dialog Box | 2-115 |
| 2.6.19 | Modifying Site Structure, Functionality, and Type                  | 2-118 |
| 2.6.20 | Adjusting Site Layout                                              | 2-120 |
| 2.6.21 | Exporting the Fiber Spans, Pairs, and Fibers in a Network          | 2-122 |
| 2.6.22 | Arranging Sites                                                    | 2-122 |
| 2.7    | Managing the Network Design                                        | 2-126 |
| 2.7.1  | Creating a Copy of the Network                                     | 2-127 |
| 2.7.2  | Creating a Network in the Install State                            | 2-127 |
| 2.7.3  | Creating an Upgrade Network                                        | 2-128 |
| 2.7.4  | Unlocking Parameters in the Network Design                         | 2-129 |
| 2.7.5  | Creating a JPEG of the Network Design                              | 2-130 |
| 2.7.6  | Upgrading a Release from 7.0 to 8.5                                | 2-130 |
| 2.8    | Generating a BoM                                                   | 2-131 |
| 2.8.1  | Viewing BoM Report Totals                                          | 2-131 |
| 2.8.2  | Generating a Network BoM                                           | 2-132 |
| 2.8.3  | Generating a Site BoM                                              | 2-133 |
| 2.8.4  | Generating a Spare Parts Report                                    | 2-134 |
| 2.8.5  | Exporting a BoM                                                    | 2-136 |



- 2.9 Managing the Price List **2-136**
  - 2.9.1 Creating a New Price List **2-136**
  - 2.9.2 Viewing a Price List **2-137**
  - 2.9.3 Loading and Unloading Price Lists **2-139**
  - 2.9.4 Updating a Price List from CCO **2-139**
  - 2.9.5 Copying a Price List **2-140**
  - 2.9.6 Deleting a Price List **2-140**
  - 2.9.7 Viewing Maintenance Contracts **2-140**

**CHAPTER 3****Modeled Network Examples 3-1**

- 3.1 Supported Cisco TransportPlanner Topologies **3-1**
- 3.2 Bus Topologies **3-1**
  - 3.2.1 Single-Span Topology **3-1**
  - 3.2.2 Point-to-Point Topology **3-2**
  - 3.2.3 Linear Topology **3-2**
- 3.3 Hubbed Ring Topology **3-2**
- 3.4 Meshed Topology **3-3**

**APPENDIX A****GUI Information and Shortcuts A-1**

- Manage the Cisco TransportPlanner Window **A-1**
  - Menu and Toolbar Options **A-2**
  - Cisco TransportPlanner Panes **A-5**
    - Project Explorer Pane **A-6**
    - Properties Pane **A-6**
    - Analyzer Pane **A-7**
    - Tasks Pane **A-8**
  - Shortcuts **A-9**
  - Site Icons **A-11**

**APPENDIX B****Card Types B-1****APPENDIX C****System Messages C-1**

- C.1 Traffic Mapping Troubleshooting **C-12**
  - C.1.1 Wavelength Exceeded **C-12**
  - C.1.2 Invalid Routing **C-13**
  - C.1.3 Cannot Find Alternate Route **C-13**
  - C.1.4 Cannot Route Service **C-14**
  - C.1.5 Overlapped Services Assigned to the Same Wavelength **C-14**

- C.1.6 Protected Services Assigned to the Same Wavelength C-15
- C.1.7 Cannot Route Service Because of Add/Drop Constraints C-15
- C.1.8 Design Requires a ROADM or Full Mux/Demux Site C-16
- C.2 Amplifier Troubleshooting C-17
  - C.2.1 Incompatible DCUs (C-Band) C-17
  - C.2.2 MMU Does Not Have Correct Amplifier (L-Band) C-17
  - C.2.3 MMU Does Not Have Correct Amplifier (C-Band) C-18
  - C.2.4 Output Power or Tilt are Out of Range C-18
  - C.2.5 Invalid Fiber Values, Types, and Loss Values C-19
  - C.2.6 Attenuator Forcing Not Allowed C-19
  - C.2.7 Unavailable Add/Drop Channels C-20
  - C.2.8 Tilt Forced When No Tilt Design is Selected C-20
  - C.2.9 Cannot Replace 32-DMX with 32DMX-0 C-21
  - C.2.10 Preamplifier Working in Invalid Mode C-21
  - C.2.11 Gain Too Low for an Amplifier C-22
  - C.2.12 Gain Too High for an Amplifier C-22
  - C.2.13 User Forcing Overridden C-23
  - C.2.14 Unsupported Configuration C-23
  - C.2.15 Channel Power Near the Fail Threshold C-24
  - C.2.16 Channel Power Below the Fail Threshold C-24
  - C.2.17 OSC Channel Power Below the Fail Threshold C-25

**APPENDIX D**

**Third-Party DWDM Wavelength Interface Model D-1**

- Interface Operative Area D-1
- Scale Factors D-4
- Single-Interfering Cross-Talk Penalty Measurement D-5
- Gaussian Cross-Talk Penalty Measurement D-6

**INDEX**



## T A B L E S

|                   |                                                                                  |       |
|-------------------|----------------------------------------------------------------------------------|-------|
| <i>Table 2-1</i>  | Supported Combination for 40-Gbps Third-Party Interface                          | 2-29  |
| <i>Table 2-2</i>  | Supported Combinations for 10-Gbps Third-Party Interface                         | 2-30  |
| <i>Table 2-3</i>  | Supported Combinations for 2.5-Gbps Third-Party Interface                        | 2-30  |
| <i>Table 2-4</i>  | Sides Labeling in Cisco Transport Planner Software R8.5 and in previous releases | 2-36  |
| <i>Table 2-5</i>  | Valid Ranges for Fiber Factor Values                                             | 2-44  |
| <i>Table 2-6</i>  | Notes Window                                                                     | 2-60  |
| <i>Table 2-7</i>  | Report Availability                                                              | 2-63  |
| <i>Table 2-8</i>  | Summary Tab Categories                                                           | 2-65  |
| <i>Table 2-9</i>  | Installation Parameters Report ANS View Tab Columns                              | 2-67  |
| <i>Table 2-10</i> | Installation Parameters Report ANP View Tab                                      | 2-68  |
| <i>Table 2-11</i> | Installation Parameters Report PP View Tab                                       | 2-68  |
| <i>Table 2-12</i> | Internal Connections Tab Columns                                                 | 2-69  |
| <i>Table 2-13</i> | Traffic Matrix Tab Columns                                                       | 2-71  |
| <i>Table 2-14</i> | Query Dialog Fields                                                              | 2-73  |
| <i>Table 2-15</i> | Layout Table (Power Consumption) Columns                                         | 2-77  |
| <i>Table 2-16</i> | Link Availability Tab Columns                                                    | 2-78  |
| <i>Table 2-17</i> | Query Dialog Fields                                                              | 2-79  |
| <i>Table 2-18</i> | Optical Results Tab Columns                                                      | 2-80  |
| <i>Table 2-19</i> | Query Dialog Fields                                                              | 2-82  |
| <i>Table 2-20</i> | Wavelength Routing Tab Columns                                                   | 2-84  |
| <i>Table 2-21</i> | BoM Diff Report Columns                                                          | 2-86  |
| <i>Table 2-22</i> | Installation Parameters Diff Report Columns                                      | 2-88  |
| <i>Table 2-23</i> | Internal Connections Tab Columns                                                 | 2-90  |
| <i>Table 2-24</i> | Site Design Rules                                                                | 2-96  |
| <i>Table 2-25</i> | Editable Fiber Properties                                                        | 2-114 |
| <i>Table 2-26</i> | Fibres Dialog Columns                                                            | 2-116 |
| <i>Table 2-27</i> | Permitted Structure Modifications                                                | 2-119 |
| <i>Table 2-28</i> | Site Modification Unlock Instances/Parameters                                    | 2-119 |
| <i>Table 2-29</i> | Allowed Site Layout Movements                                                    | 2-121 |
| <i>Table 2-30</i> | BoM Net View Columns                                                             | 2-132 |

|            |                                                                                      |       |
|------------|--------------------------------------------------------------------------------------|-------|
| Table 2-31 | BoM Site View Columns                                                                | 2-134 |
| Table 2-32 | BoM Spare Subtab Columns                                                             | 2-135 |
| Table A-1  | Menu and Toolbar Options                                                             | A-2   |
| Table A-2  | Project Explorer Toolbar Options                                                     | A-6   |
| Table A-3  | Properties Pane Toolbar Options                                                      | A-7   |
| Table A-4  | Analyzer Toolbar Options                                                             | A-8   |
| Table A-5  | Tasks Pane Toolbar Options                                                           | A-8   |
| Table A-6  | Shortcut Menu Actions                                                                | A-10  |
| Table A-7  | Site Icons                                                                           | A-12  |
| Table B-1  | OC-192/STM-64 (9.953 Gbps)                                                           | B-1   |
| Table B-2  | OC-48/STM-16 (2.488 Gbps)                                                            | B-2   |
| Table B-3  | OC-12/STM-4 (622 Mbps)                                                               | B-3   |
| Table B-4  | OC-3/STM-1 (155 Mbps)                                                                | B-3   |
| Table B-5  | 10 Gigabit Ethernet Wide Area Network ATM Physical Layer (10GE WAN PHY) (9.953 Gbps) | B-3   |
| Table B-6  | 10 Gigabit Ethernet Local Area Network ATM Physical Layer (10GE LAN PHY)(10.3 Gbps)  | B-4   |
| Table B-7  | Gigabit Ethernet (1.25Gbps)                                                          | B-5   |
| Table B-8  | Fast Ethernet (100 Mbps)                                                             | B-5   |
| Table B-9  | Fiber Channel 10G (10.5 Gbps)                                                        | B-6   |
| Table B-10 | Fiber Channel 4G (4.25 Gbps)                                                         | B-6   |
| Table B-11 | Fiber Channel 2G (2.125 Gbps)                                                        | B-6   |
| Table B-12 | Fiber Channel 1G (1.062 Gbps)                                                        | B-7   |
| Table B-13 | 2 Gbps Fiber Connectivity (2.125 Gbps)                                               | B-7   |
| Table B-14 | FICON-1G (1.062 Gbps)                                                                | B-8   |
| Table B-15 | Enterprise System Connection (ESCON) (200 Mbps)                                      | B-8   |
| Table B-16 | ISC-3 Compatibility Mode (1.062 Gbps)                                                | B-9   |
| Table B-17 | ISC-Peer 2R                                                                          | B-9   |
| Table B-18 | ISC-3 Peer-1G (1.062 Gbps)                                                           | B-9   |
| Table B-19 | ISC-3 Peer-2G (2.125 Gbps)                                                           | B-10  |
| Table B-20 | Sysplex External Throughput Rate (8 Mbps)                                            | B-10  |
| Table B-21 | Sysplex Control Link Oscillator (8 Mbps)                                             | B-10  |
| Table B-22 | Serial Data Input                                                                    | B-10  |
| Table B-23 | Digital Video Broadcast-Asynchronous Serial Interface                                | B-10  |
| Table B-24 | D1-Video (270 Mbps)                                                                  | B-11  |
| Table B-25 | High Definition Television (HDTV) (1.48 Gbps)                                        | B-11  |
| Table B-26 | DV-6000 (2.38 Gbps)                                                                  | B-11  |

|            |                                                      |             |
|------------|------------------------------------------------------|-------------|
| Table B-27 | 2R Any Rate                                          | <b>B-11</b> |
| Table B-28 | ONS 15530 2.5G ITU-T                                 | <b>B-11</b> |
| Table B-29 | ONS 15530 10G ITU-T                                  | <b>B-12</b> |
| Table C-1  | Error Messages                                       | <b>C-1</b>  |
| Table C-2  | Wavelength Exceeded                                  | <b>C-13</b> |
| Table C-3  | Invalid Routing                                      | <b>C-13</b> |
| Table C-4  | Cannot Find Alternate Route                          | <b>C-14</b> |
| Table C-5  | Cannot Route Service                                 | <b>C-14</b> |
| Table C-6  | Overlapped Services Assigned to the Same Wavelength  | <b>C-15</b> |
| Table C-7  | Protected Services Assigned to the Same Wavelength   | <b>C-15</b> |
| Table C-8  | Cannot Route Service Because of Add/Drop Constraints | <b>C-16</b> |
| Table C-9  | Cannot Route Service Because of Add/Drop Constraints | <b>C-16</b> |
| Table C-10 | Incompatible DCUs (C-Band)                           | <b>C-17</b> |
| Table C-11 | MMU Does Not Have the Correct Amplifier (L-Band)     | <b>C-18</b> |
| Table C-12 | MMU Does Not Have the Correct Amplifier (C-Band)     | <b>C-18</b> |
| Table C-13 | Output Power or Tilt are Out of Range                | <b>C-18</b> |
| Table C-14 | Invalid Fiber Values, Types, and Loss Values         | <b>C-19</b> |
| Table C-15 | Attenuator Forcing Not Allowed                       | <b>C-19</b> |
| Table C-16 | Unavailable Add/Drop Channels                        | <b>C-20</b> |
| Table C-17 | Tilt Forced When No Tilt Design is Selected          | <b>C-20</b> |
| Table C-18 | Cannot Replace 32-DMX with 32DMX-O                   | <b>C-21</b> |
| Table C-19 | Preamplifier Working in Invalid Mode                 | <b>C-22</b> |
| Table C-20 | Gain Too Low for an Amplifier                        | <b>C-22</b> |
| Table C-21 | Gain Too High for an Amplifier                       | <b>C-23</b> |
| Table C-22 | User Forcing Overridden                              | <b>C-23</b> |
| Table C-23 | Unsupported Configuration                            | <b>C-24</b> |
| Table C-24 | Channel Power Near the Fail Threshold                | <b>C-24</b> |
| Table C-25 |                                                      | <b>C-24</b> |
| Table C-26 | OSC Channel Power Below the Fail Threshold           | <b>C-25</b> |





## About this Guide

---

This section explains the objectives, intended audience, and organization of this publication and describes the conventions that convey instructions and other information.

This section provides the following information:

- [Document Objectives](#)
- [Audience](#)
- [Document Organization](#)
- [Related Documentation](#)
- [Document Conventions](#)
- [Obtaining Optical Networking Information](#)
- [Obtaining Documentation, Obtaining Support, and Security Guidelines](#)

## Revision History

This is the first issue of this publication.

## Document Objectives

The *Cisco TransportPlanner DWDM Operations Guide, Release 8.5* explains how to design networks using the Cisco TransportPlanner design tool for the Cisco ONS 15454 SONET and SDH systems. It contains information about how to design an optical network. Use the *Cisco TransportPlanner DWDM Operations Guide, Release 8.5* in conjunction with the appropriate publications listed in the [Related Documentation](#) section.

## Audience

This publication is intended for experienced network system engineers who are responsible for planning and ordering equipment for Cisco optical networking systems.

# Document Organization

This *Cisco TransportPlanner DWDM Operations Guide, Release 8.5* is organized into the following chapters:

- [Chapter 1, “Overview”](#) provides a list of features, an overview of the network design process, a description of the internal architecture, and the Cisco TransportPlanner procedural flow.
- [Chapter 2, “Designing Networks with Cisco TransportPlanner”](#) provides instructions for using the Cisco TransportPlanner tool to create a network design, adjust and optimize design components, and generate reports and bills of materials.
- [Chapter 3, “Modeled Network Examples”](#) provides examples of typical optical networks that you can model using Cisco TransportPlanner.
- [Appendix A, “GUI Information and Shortcuts”](#) provides Cisco TransportPlanner graphical user interface shortcuts.
- [Appendix B, “Card Types”](#) provides a list of card types that can be used to build a network, and the corresponding Cisco product identifier.
- [Appendix C, “Error Messages”](#) provides a list of system errors.
- [Appendix D, “Third-Party DWDM Wavelength Interface Model”](#) provides reference information on third-party DWDM interface calculation.

## Related Documentation

Use this *Cisco TransportPlanner DWDM Operations Guide, Release 8.5* with the following referenced publications:

- *Cisco ONS 15454 DWDM Procedure Guide, R8.5*—Provides procedures to install, turn up, provision, and maintain a Cisco ONS 15454 node and network.
- *Cisco ONS 15454 DWDM Reference Manual, R8.5*—Provides reference material for Cisco ONS 15454 nodes and networks.
- *Cisco ONS 15454 DWDM Troubleshooting Guide, R8.5*—Provides general troubleshooting procedures and alarm descriptions.
- *Cisco SONET TLI Command Guide, R8.5* and *Cisco SDH TLI Command Guide, R8.5*—Provide test access TLI commands, configurations, and parameter types.
- *Release Notes for the Cisco ONS 15454, R8.5* and *Release Notes for the Cisco ONS 15454 SDH, R8.5*—Provide caveats, closed issues, and new feature and functionality information.

## Document Conventions

This publication uses the following conventions:

| Convention      | Application                                 |
|-----------------|---------------------------------------------|
| <b>boldface</b> | Commands and keywords in body text.         |
| <i>italic</i>   | Command input that is supplied by the user. |



| Convention                  | Application                                                                                                     |
|-----------------------------|-----------------------------------------------------------------------------------------------------------------|
| [ ]                         | Keywords or arguments that appear within square brackets are optional.                                          |
| { x   x   x }               | A choice of keywords (represented by x) appears in braces separated by vertical bars. The user must select one. |
| Ctrl                        | The control key. For example, where Ctrl + D is written, hold down the Control key while pressing the D key.    |
| screen font                 | Examples of information displayed on the screen.                                                                |
| <b>boldface screen font</b> | Examples of information that the user must enter.                                                               |
| < >                         | Command parameters that must be replaced by module-specific codes.                                              |

**Note**

Means *reader take note*. Notes contain helpful suggestions or references to material not covered in the document.

**Caution**

Means *reader be careful*. In this situation, the user might do something that could result in equipment damage or loss of data.

**Warning****IMPORTANT SAFETY INSTRUCTIONS**

**This warning symbol means danger. You are in a situation that could cause bodily injury. Before you work on any equipment, be aware of the hazards involved with electrical circuitry and be familiar with standard practices for preventing accidents. To see translations of the warnings that appear in this publication, refer to the translated safety warnings that accompanied this device.**

**Note: SAVE THESE INSTRUCTIONS**

**Note: This documentation is to be used in conjunction with the specific product installation guide that shipped with the product. Please refer to the Installation Guide, Configuration Guide, or other enclosed additional documentation for further details.**

## Obtaining Optical Networking Information

This section contains information that is specific to optical networking products. For information that pertains to all of Cisco, refer to the [Obtaining Documentation, Obtaining Support, and Security Guidelines](#) section.

## Where to Find Safety and Warning Information

For safety and warning information, refer to the *Cisco Optical Transport Products Safety and Compliance Information* document that accompanied the product. This publication describes the international agency compliance and safety information for the Cisco ONS 15454 system. It also includes translations of the safety warnings that appear in the ONS 15454 system documentation.

## Cisco Optical Networking Product Documentation CD-ROM

Optical networking-related documentation, including Cisco ONS 15xxx product documentation, is available in a CD-ROM package that ships with your product. The Optical Networking Product Documentation CD-ROM is updated periodically and may be more current than printed documentation.

## Obtaining Documentation, Obtaining Support, and Security Guidelines

For information on obtaining documentation, obtaining support, providing documentation feedback, security guidelines, and also recommended aliases and general Cisco documents, see the monthly *What's New in Cisco Product Documentation*, which also lists all new and revised Cisco technical documentation, at:

<http://www.cisco.com/en/US/docs/general/whatsnew/whatsnew.htm>



# CHAPTER 1

## Overview

---



### Note

Cisco MetroPlanner has been renamed as Cisco TransportPlanner starting with release 8.5.

---

Cisco TransportPlanner Software R8.5 provides a way to model and test wavelength division multiplexing (WDM) optical networks in a graphical environment. The primary purpose of Cisco TransportPlanner is to help sales engineers (SEs) design and validate networks of Cisco Optical Networking System (ONS) 15454 Multi-Service Transport Platforms (MSTP). Using Cisco TransportPlanner Software R8.5, an SE can create multiple instances of a network to modify different parameters in each instance for comparison. Cisco TransportPlanner generates a shelf view of all the sites deployed in the optical network and provides a complete bill of materials (BOM) for the network and the differences between instances of a network.

This chapter describes how you use Cisco TransportPlanner to design, analyze, and optimize new or existing Cisco optical networks and contains the following sections:

- [1.1 Cisco TransportPlanner Features, page 1-1](#)
- [1.2 Network Design Process, page 1-2](#)
- [1.3 Cisco TransportPlanner Process Flow, page 1-5](#)
- [1.4 Planning Traffic in Cisco TransportPlanner, page 1-7](#)
- [1.5 Cisco TransportPlanner Traffic in the Project Explorer Pane, page 1-8](#)
- [1.6 Auto, Forced, and Locked Parameters, page 1-11](#)

## 1.1 Cisco TransportPlanner Features

Cisco TransportPlanner Software R8.5 provides a simple tool set for designing optical networks with Cisco ONS 15454 MSTP products. You can enter all of the network parameters or minimal information, such as site distance, and Cisco TransportPlanner will model the network you need to build and generate a detailed BOM with ordering information. Designing optical networks requires the verification of multiple constraints such as optical budget limitations and platform architectural restrictions. One Cisco TransportPlanner project can contain multiple copies of a network. This allows you to change parameters in one network copy, then analyze and compare to another network copy to determine the differences. In addition to this capability, Cisco TransportPlanner Software R8.5 provides the following new features:

- Network upgrade to implement forecasted channels
- Slot preprovisioning (by importing the NE Update file into the Cisco Transport Controller [CTC])

- User-defined equipment lists in the parts database
- Fiber separation allowing a user to manage certain parameters (such as loss) for each strand in a fiber pair
- Forced equipment settings (user-defined parameters instead of Cisco TransportPlanner automatic settings)
- Power consumption calculation
- L-band design
- C-band enhanced booster
- C-band plus L-band/50-GHz scalable design
- Multishelf management
- New DWDM client interfaces
- Meshed reconfigurable optical add/drop multiplexing (ROADM)
- Capability to select the type of maintenance contract desired to appear in the BOM
- Support for OPT-AMP-C amplifier
- Support for GE and 10GE Xponder
- Support for 10G ADM blade

## 1.2 Network Design Process

To generate a network design, the SE enters the following parameters:

- The topology of the network—ring, linear, or meshed
- The type of equipment used at each site
- The distance separating the sites
- The type of fiber connecting the sites
- Service demands, including the service type, the protection type, and the number of channels between nodes
- The number of network sites

When the network parameters are entered, Cisco TransportPlanner finds the best routing, defines the required add/drop filters, and places optical amplifiers and dispersion compensation units (DCUs) to fit the user traffic demands at the minimum cost. Optimization is performed to meet the boundary conditions. The optimization includes attenuation and amplification.

Finally, Cisco TransportPlanner generates a BOM, which includes the product codes, the quantities, and pricing information. In addition, it creates other reports, such as a shelf-level view of the configuration, which can be printed. This helps the SE understand how the shelf is built and helps to avoid confusion and errors during the actual deployment. Within the BOM is the total network cost, which allows a quick comparison of various design options. The total network cost is the cost of the equipment for all of the sites in the designed network.

## 1.2.1 Network Design Constraints

Cisco TransportPlanner searches for the best solution to a designed network using an optimization algorithm.

A network design must meet the optical budget and receiver overload criteria to operate efficiently. An analysis of optical budget and receiver overload evaluates the strength of the signal traversing the ring. If a design solution satisfies the constraints, it is a valid design. The Cisco TransportPlanner Software R8.5 optimization algorithms generate multiple solutions and verifies the constraints against those solutions. If the constraints are satisfied, the solution with the lowest cost-to-utilization ratio is selected as the optimal solution.

If the network design solution fails to satisfy all the constraints, Cisco TransportPlanner Software R8.5 makes adjustments to parameters such as signal attenuation and amplification. Amplification is achieved by using an erbium-doped fiber amplifier (EDFA). Attenuation is achieved by using variable optical attenuator (VOA) modules integrated into the platform. Cisco TransportPlanner Software R8.5 corrects the optical budget using an algorithm that includes automatic placement of EDFAs and VOA regulation.

For each internodal demand, Cisco TransportPlanner Software R8.5 performs an optical budget and receiver overload analysis and displays the results in various reports in the Graphical User Interface (GUI). If the network design algorithms are not able to provide a solution, then you can modify the input data (for example, by relaxing some user constraints) and run the analysis again.

## 1.2.2 Platform Support

Cisco TransportPlanner Software R8.5 supports the Cisco ONS 15454 DWDM optical platform Software Releases 4.7, 5.0.x, 7.0.x, and 8.x.

## 1.2.3 Topology Support

Cisco TransportPlanner 8.5 supports the following network topologies:

- Bus (single span, point-to-point, and linear)
- Open (or hubbed) ring
- Closed (or meshed) ring
- Any-to-any ring (ROADM)
- Meshed network

Cisco TransportPlanner Software R8.5 allows you to design flexible networks with up to 100 site locations. A flexible network is a network that, using ROADM nodes, allows traffic modification/reconfiguration as traffic requirements change.

For Cisco TransportPlanner Software R8.5, the maximum number of locations where the optical service channel (OSC) is terminated is 40. The maximum number of add/drop locations is 40.

## 1.2.4 Protection Scheme Support

Cisco TransportPlanner Software R8.5 designs support the following protection schemes:

- Y-cable protected—In Y-cable protection, one transponder card is designated as active and the other as standby. The standby transponder card has the client-side laser turned off to avoid corrupting the signal transmitted back to the client. The active transponder monitors the signal from the trunk side and in the event of loss or signal failure, the system switches to the standby path.
- Client-based 1+1—Two client signals are transmitted to separated line cards or transponder cards instead of using a Y-cable to split one client signal into two line cards or transponder cards. In client 1+1 protection, the failure and switchover is controlled by the client system.
- Fiber-switched protection—The single client signal is injected into the client receive (Rx) port. It is then split into two separate signals on the two trunk transmit (Tx) ports. The two signals are transmitted over diverse paths. The far-end card chooses one of the two trunk Rx port signals and injects it into the Tx client port.
- Unprotected—Protection is not used.
- External card switch—Protection not used.

## 1.2.5 Service Support

Cisco TransportPlanner Software R8.5 can support any subset of the following services:

- Alien (third-party DWDM interface)
- Cisco ONS 15530 2.5 Gbps Aggregated
- ONS 15530 10 Gbps Aggregated
- ONS 15530 Multirate (MR) Transport
- ONS 15530 Data Multiplexer (MXP)
- 2R Any Rate
- Gigabit Ethernet
- 10GE—10 Gigabit Ethernet (LAN and WAN)
- D1 Video
- DVB-ASI—Digital Video Broadcast-Asynchronous Serial Interface
- DV-6000
- ESCON—Enterprise System Connection
- Fast Ethernet
- Fibre Channel 1G
- Fibre Channel 2G
- Fibre Channel 4G
- Fibre Channel 10G
- FICON—Fiber Connection 1G
- FICON Express 2G
- FICON 4G

- High Definition Television (HDTV)
- ISC-3 Peer (1G)
- ISC-3 Peer (2G)
- ISC-3 Peer (2R)
- ISC-Compat (ISC-3 Compatibility Mode)
- OC-3
- OC-12
- OC-48
- OC-192
- OC-768
- SDI—Serial Data Input
- STM-1
- STM-4
- STM-16
- STM-64
- STM-256
- Sysplex CLO—control link oscillator
- Sysplex ETR—external throughput rate

**Note**

The Sysplex CLO and Sysplex ETR services are supported only on the following topologies:

- Single span—Two terminal sites with 32MUX-O and 32DMX-O cards, 40MUX-O and 40DMX-O cards, 40WSS and 40DMX, or 32WSS and 32DMX or 32DMX-O cards installed and no intermediate sites in between.
- Point-to-Point—Two terminal sites with 32MUX-O and 32DMX-O cards, 40MUX-O and 40DMX-O cards, 40WSS and 40DMX, or 32WSS and 32DMX or 32DMX-O cards installed. Line amplifiers can be installed between the terminal sites, but intermediate (traffic terminating) sites cannot be installed.
- Two hubs—Two hub nodes in a ring with 32MUX-O, 32DMX-O, 32WSS, 40MUX-O, 40DMX, 40DMX-O, 40WSS, and 32DMX cards or 32DMX-O cards installed. Line amplifiers can be installed between the hubs.

Refer to the *Cisco ONS 15454 DWDM Reference Manual* for more information about the supported topologies for the ETR and CLO services.

## 1.3 Cisco TransportPlanner Process Flow

The following stages are used to complete a network design. See [Figure 1-1](#) for the process flow.

1. Create a project using the Project Creation wizard.
2. Create a network using the Create Network wizard. The Create Network wizards adds sites and places the fiber spans between the sites. A span represents a pair of fibers.

3. Create a point-to-point, AggregatedEthernet, TDM Aggregated, protected ring (P-ring), and/or ROADM service demand.
4. Analyze the network design.
5. If you would like to force automatic tool choices, adjust the design and repeat the analysis until you have reached the desired configuration.
6. Create an Install copy of the network and update the parameters with real data from the field.
7. Analyze the Install network.
8. Create an upgrade copy of the network, as needed, to add forecasted channels.

Figure 1-1 Cisco TransportPlanner Process Flow

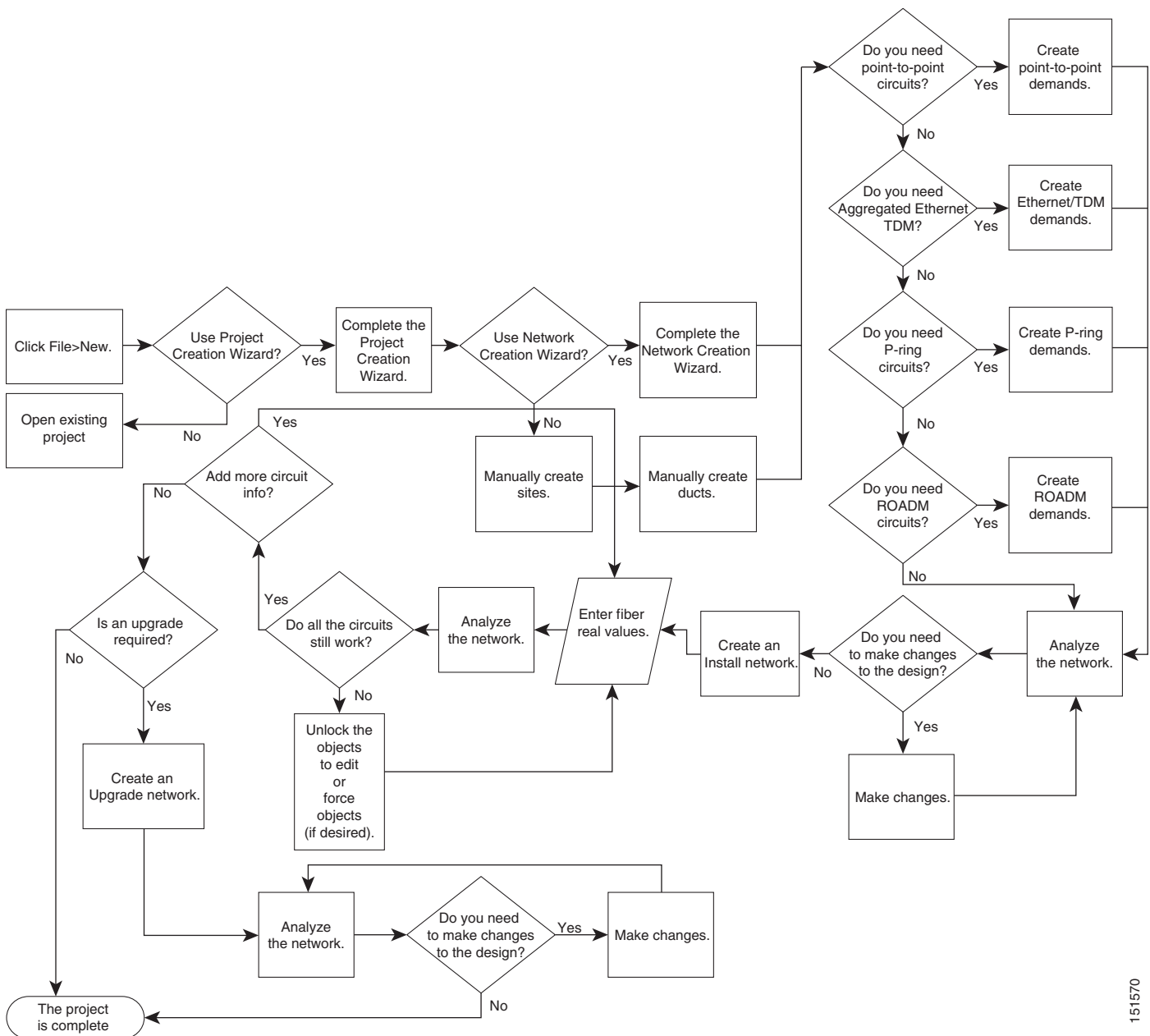

151570



## 1.4 Planning Traffic in Cisco TransportPlanner

Traffic in Cisco TransportPlanner is defined as an optical path for each pair of nodes requiring a service demand. An optical path is the combined channels between the two nodes. The following list gives definitions for some basic traffic items:

- **Circuit**—A single channel between a pair of source and destination nodes. In addition to the source and destination nodes and all the attributes that are common to the service containing the circuit, a circuit has the following attributes:
  - Present/forecast indication
  - Routing direction for unprotected service
  - ITU channel
  - Optical bypass indication
- **Demand**—A set of circuits with common characteristics, such as:
  - Service demand label
  - Number of existing circuits
  - Number of forecasted circuits
  - Client service type
  - Protection type
  - Optical bypass (number of channels and/or sites)
  - WDM interface type (TXT or ITU-LC)
  - WDM card type
  - Source client interface (SR, IR, or LR)
  - Destination client interface (SR, IR, or LR)
- **Traffic demand**—All traffic between the same set of nodes. Both L-band and C-band are supported. The following traffic demands are supported: P-ring, Fixed (point-to-point), and Any-to-any (ROADM).

In P-ring traffic demands, all the demands are used to support traffic topologies similar to bidirectional line switched rings (BLSRs) or multiplex section-shared protection rings (MS-SPRings). Each P-ring demand is between a pair of added/dropped nodes where BLSR-like (or MS-SPRing-like) traffic must exist. The number of circuits is the same for each demand, and is user-specified (from 1 to 40).

In fixed (point-to-point) traffic demands, the set of nodes is restricted to two sites. The number of circuits is user-specified (from 1 to 40).

In any-to-any (ROADM) traffic demands, a minimum of two nodes and a maximum of 40 ROADM nodes are supported. An any-to-any traffic demand allows each node to establish one or more circuits with the other nodes, either as a hub or meshed configuration. In a meshed configuration, each node defined in the set is connected to each other node. This is the most common traffic type. In a hub configuration, the user-defined hub node is connected to each of the other nodes. ROADM circuits have the same protection types and services. The number of circuits is not user-specified and can vary from 0 to 40.

A ROADM demand can have multiple client service types and supports multiple DWDM card interfaces for each client service type. A ROADM demand supports the following routing strategies:

- **Protected (Default)**—Each node pair in the traffic demand is connected using two connections.

- Unprotected optimum optical path—Each node pair is connected using one connection. The unprotected optimum optical path minimizes the number of required optical amplifiers, but also restricts the number of channels that can be deployed among the nodes of the traffic demand (maximum of 40 channels between each node pair) in the installed network.
- Unprotected minimum hop count—Each node pair in the traffic demand is connected by one connection. The unprotected minimum hop count maximizes the number of channels (for unprotected traffic types only) that can be deployed among the nodes of the traffic demand, but can require a higher number of optical amplifiers on the unprotected optimum optical path (maximum of 40 channels between each node pair) in the installed network.
- Unprotected subnet—Each node pair in the traffic demand is connected using one connection. You can manually force connections on only one branch of the ring. For unprotected subnets, you must manually select one starting node of the branch and the direction the ring must be traversed to define the subnet, starting from the initial site. The branch direction is specified by defining the outgoing side first, referred to as the starting node. This routing strategy option allows you to exclude some critical paths and (with ROADM traffic demands containing two sites) to force each ROADM connection clockwise or counterclockwise.

## 1.5 Cisco TransportPlanner Traffic in the Project Explorer Pane

Cisco TransportPlanner Software R8.5 represents all of the user-defined traffic services as a tree view within the Project Explorer pane. The Project Explorer shows all of the open project information, including the networks, the network dependencies, sites, fibers, services, etc. (Figure 1-2).

**Figure 1-2** Project Explorer View

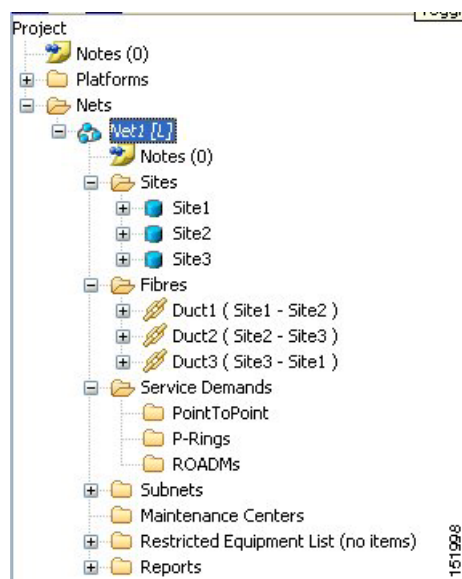

After you analyze a network design, the colors of tree view change according to the error/warning condition of the network design. The icons display as red if there are errors in the network design; orange if there are warnings but no errors; and green if there are no warnings or errors. The icon shows the color of the most severe condition. For more information about analyzing the network, see the “2.4 Analyzing the Network” section on page 2-62.

Right-clicking on certain items in the Project Explorer tree allows you to edit the parameters. Refer to [Chapter 2, “Designing Networks with Cisco TransportPlanner”](#) for more information about optical results, the traffic matrix, and editing.

## 1.5.1 Point-to-Point Traffic Demands

Point-to-point traffic demands appear in the Service Demands > PointToPoint folder in the Project Explorer pane. Each point-to-point traffic demand is categorized by its source and destination site names. All of the point-to-point services between the two sites appear under the designated demand name ([Figure 1-3](#)).

**Figure 1-3** Point-to-Point Traffic Demand in the Project Explorer



A point-to-point traffic demand includes the following information:

- Client service type
- Site# – Site# (source and destination site labels for this demand)

## 1.5.2 P-Ring Traffic Demands

Each protected ring (P-ring) traffic demand appears in the Project Explorer pane under the Service Demands > P-Rings folder. [Figure 1-4](#) shows an example of a P-ring traffic demand in the Project Explorer.

**Figure 1-4** P-Ring Traffic Demand in the Project Explorer

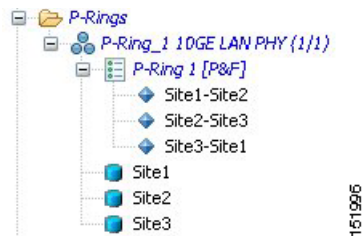

All the P-ring channels between each site pair are listed under each P-ring traffic demand. Each demand is labeled with the following information:

- P-ring number
- Client service type
- Site# – Site# (source and destination site labels for this demand)

## 1.5.3 ROADM Traffic Demands

Each ROADM traffic demand appears in the Project Explorer under the Service Demands > ROADMs folder. The ROADM folder contains each defined ROADM demand. You can define more demands for the same ROADM for the same set of nodes. [Figure 1-5](#) shows an example of a ROADM traffic demand.

**Figure 1-5** *ROADM Traffic Demand in the Project Explorer*

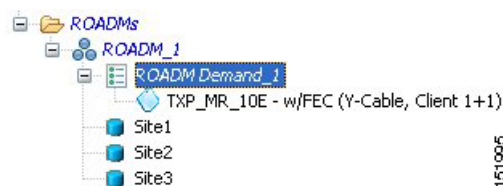

In the Project Explorer, each ROADM includes the ROADM demand name and a list of DWDM card types that support the client service types. Protection types appear in parentheses.

## 1.5.4 Aggregated Ethernet Demand

Each aggregated ethernet traffic demand appears in the Project Explorer under the Service Demands > Aggregated Ethernet folder. The Aggregated Ethernet folder contains each defined aggregated ethernet demand. Aggregated Ethernet demands are supported on ring and linear traffic subnets. [Figure 1-6](#) shows an example of a aggregated ethernet traffic demand.

**Figure 1-6** *Aggregated Ethernet Demand in Project Explorer*

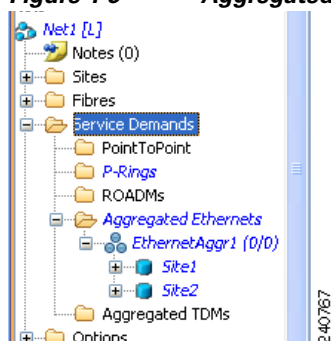

## 1.5.5 TDM Aggregated Demand

Each TDM aggregated demand appears in the Project Explorer pane under the Service Demands > Aggregated TDMs folder. [Figure 1-7](#) shows an example of a TDM aggregated traffic demand in the Project Explorer.

**Figure 1-7** *TDM Aggregated Demand in Project Explorer*

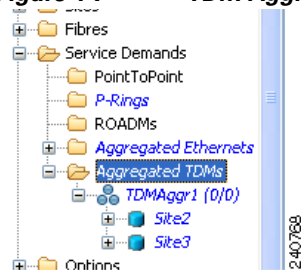

TDM aggregated demands are supported only on a ring traffic subnet.

## 1.6 Auto, Forced, and Locked Parameters

Parameters in Cisco TransportPlanner can be in one of three states:

- Auto— This allows the highest degree of flexibility to the Cisco TransportPlanner in designing a network. When a user selects Auto, Cisco TransportPlanner chooses the parameter value during network analysis.
- Forced—When a user sets a specific parameter value, other than Auto, Cisco TransportPlanner designs the network using these constraints. When a setting is forced, the item appears in blue italics in the Project Explorer pane.
- Locked—The state of a parameter after network analysis. The next time the analyzer is run, Cisco TransportPlanner cannot change the value when in the Locked state. A user can unlock an item using the Unlock command. For more information, see the “[2.7.4 Unlocking Parameters in the Network Design](#)” section on page 2-129. [Figure 1-8](#) shows an example of sites in a locked state.

**Figure 1-8**      *Locked Sites in the Project Explorer View*



Depending on the initial state, the network analyzer will:

- Move the parameter into the Locked state when the unit or parameter was set to Auto.
- Leave the parameter in the same state if the user forced a specific value for the unit or parameter.





## CHAPTER 2

# Designing Networks with Cisco TransportPlanner

---

Cisco TransportPlanner provides you with numerous tools for customizing the software, creating and analyzing networks, and creating a bill of materials (BoM). You can use Cisco TransportPlanner to perform the following tasks:

- [2.1 Launching Cisco TransportPlanner, page 2-14](#)
- [2.2 Setting Cisco TransportPlanner Options, page 2-18](#)
- [2.3 Creating a Project, page 2-36](#)
- [2.4 Analyzing the Network, page 2-62](#)
- [2.5 Viewing Network Reports, page 2-62](#)
- [2.6 Editing a Project, page 2-90](#)
- [2.7 Managing the Network Design, page 2-126](#)
- [2.8 Generating a BoM, page 2-131](#)
- [2.9 Managing the Price List, page 2-136](#)



### Note

To run Cisco TransportPlanner, you must install Java Runtime Environment (JRE) 1.5.0. You can download it from the following URL:

<http://java.sun.com/j2se/1.5.0/download.jsp>

---

## 2.1 Launching Cisco TransportPlanner

Before you start Cisco TransportPlanner, you need to save the user profiles provided to you by Cisco Systems to the profiles directory. Access to Cisco TransportPlanner features depends on the user profile you select when you start Cisco TransportPlanner. The default profile is Network Designer.

**Note**

In Cisco TransportPlanner Software Release 8.5, the user does not need a user ID and password to log into Cisco TransportPlanner.

Use the following procedure to launch Cisco TransportPlanner:

- Step 1** Copy the CTP-v850.zip file to your hard drive.
- Step 2** Extract the ZIP file using the Extract to Folder option.
- Step 3** Copy the profiles provided to you to the profiles folder.
- Step 4** Launch Cisco TransportPlanner by double-clicking the ctp.jar file.

The Cisco TransportPlanner 8.5 Login dialog box appears (Figure 2-1).

**Figure 2-1 Cisco TransportPlanner 8.5 Login Dialog Box**

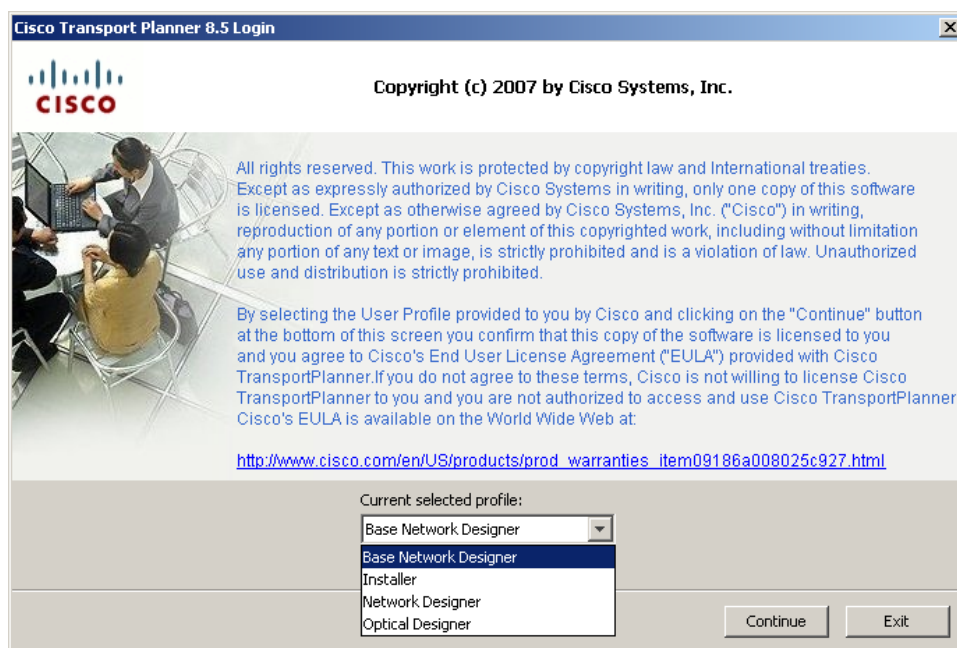

- Step 5** Click **Continue** to open Cisco TransportPlanner.

The login profile type appears in the lower right corner of the Cisco TransportPlanner window.



## 2.1.1 Opening a Project

Use the following procedure to open an existing Cisco TransportPlanner project. To create a new project, see the “2.3 Creating a Project” section on page 2-36.

- Step 1** Click the project name under Open in the Tasks Pane (Figure 2-2). The project opens. If you do not see the project name listed, continue with Step 2.
- Step 2** Click **Open** under Project in the Tasks Pane or in the File menu.

**Figure 2-2** Opening a Project from the Tasks Pane

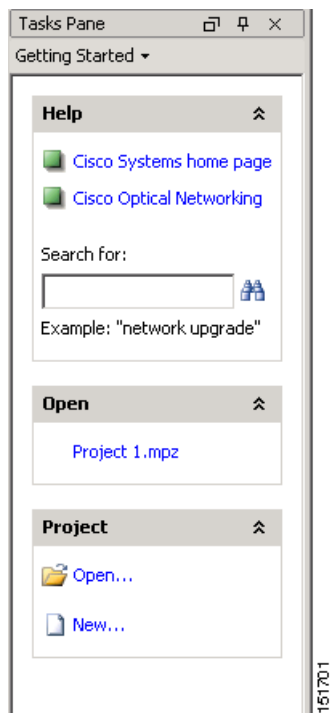

- Step 3** In the Open Project dialog box, navigate to the desired directory and choose the project. Click **Open**. The Cisco TransportPlanner project appears.

## 2.1.2 Loading and Unloading Networks

Each network in a project requires memory. To save memory, when Cisco TransportPlanner opens a project, all networks are in the Unloaded state. An unloaded network appears in the Project Explorer with a “U” next to the network identifier (Figure 2-3). To load an unloaded network, double-click on the network folder in the Project Explorer, or right-click the network and choose **Load** from the shortcut menu.

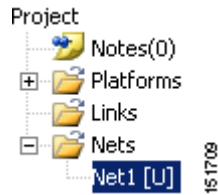
**Figure 2-3 Unloaded Network in the Project Explorer**

A loaded network appears in the Project Explorer with an “L” next to the network identifier (Figure 2-4). To unload a loaded network, right-click the network icon in the Project Explorer and choose **Unload** from the shortcut menu.

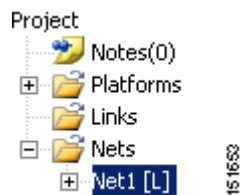
**Figure 2-4 Loaded Network in the Project Explorer**

## 2.1.3 Saving a Project

Use the following procedure to save a project:

- 
- Step 1** Choose one of the following:
- To save an existing project with the same filename, choose **File > Save**. You have completed this procedure.
  - To save a new project, choose **File > Save** and go to [Step 2](#).
  - To save an existing project with a different filename, choose **File > Save As** and go to [Step 2](#).
- Step 2** In the Save Project dialog box, navigate to the desired directory and type the filename. Click **Save**. Cisco TransportPlanner saves projects as zipped files with the MPZ extension.
- 

## 2.1.4 Importing a Cisco TransportPlanner Release 2.5 Project

Use the following procedure to import a Cisco TransportPlanner Release 2.5 project:

- 
- Step 1** From the File menu, choose **Import 2.5.x project**.
- Step 2** In the Open Project dialog box, navigate to the desired directory and choose the project. Cisco TransportPlanner Release 2.5 projects have a file extension of CMZ.
- Step 3** Click **Open**. The Import *R2.5-Project-Name* dialog box appears ([Figure 2-5](#)).

Figure 2-5 Import &lt;R2.5 Project Name&gt; Dialog Box

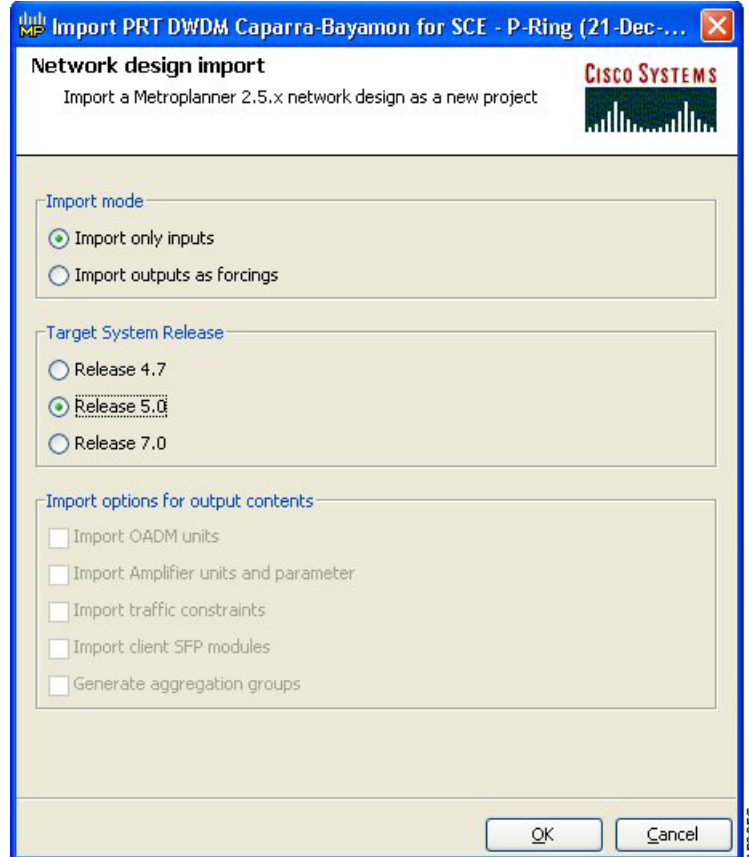

**Step 4** Choose one of the following:

- **Import only inputs**—Choose this option to import all of the Cisco TransportPlanner 2.5x project input data. The Cisco TransportPlanner 7.0x will define service aggregation, routing of services, amplifiers, and dispersion compensation units (DCU) during network analysis.
- **Import outputs as forcings**—Choose this option to import all of the Cisco TransportPlanner 2.5x input and output data with the exception of the optical results and installation parameters. When you run the network analyzer in Cisco TransportPlanner 7.0x, it does not change the imported output data parameters; the network analyzer treats these imported values as forced parameters.

**Step 5** In the Target System Release area, choose the desired release: **Release 4.7**, **Release 5.0**, **Release 7.0**.

**Step 6** If you chose Import outputs as forcings, choose the desired outputs to import:

- Import OADM units
- Import Amplifier units and parameter
- Import traffic constraints
- Import client SFP modules
- Generate aggregation groups

**Step 7** Click **OK**. The Cisco TransportPlanner Release 2.5 project appears.

## 2.1.5 Closing a Project

Use the following procedure to close a Cisco TransportPlanner project:

- 
- Step 1** From the File menu, choose **Close**.
  - Step 2** In the Save Project dialog box, click **Yes** to save or **No** to close without saving changes.
  - Step 3** If you clicked Yes and have not previously save the project, the Save Project dialog box appear. Type the name of the project and click **Save**. The project closes.
  - Step 4** To exit Cisco TransportPlanner, choose **Exit** from the File menu.
- 

## 2.2 Setting Cisco TransportPlanner Options

Cisco TransportPlanner provides numerous options for customizing the tool and the design.

**Note**

---

The following procedures for setting options using the Tools menu apply to new projects during project creation. To change an existing (open) project, click the desired item in the Project Explorer pane Subnets folder and edit the parameter in the Properties pane.

---

### 2.2.1 Setting the Graphical Display

Use the following procedure to set the Cisco TransportPlanner graphical display:

- 
- Step 1** From the Tools menu, choose **Options**.
  - Step 2** In the Options Explorer dialog box ([Figure 2-6](#)), right-click the Graphic folder and choose **Expand** from the shortcut menu.

Figure 2-6 Options Explorer Dialog Box

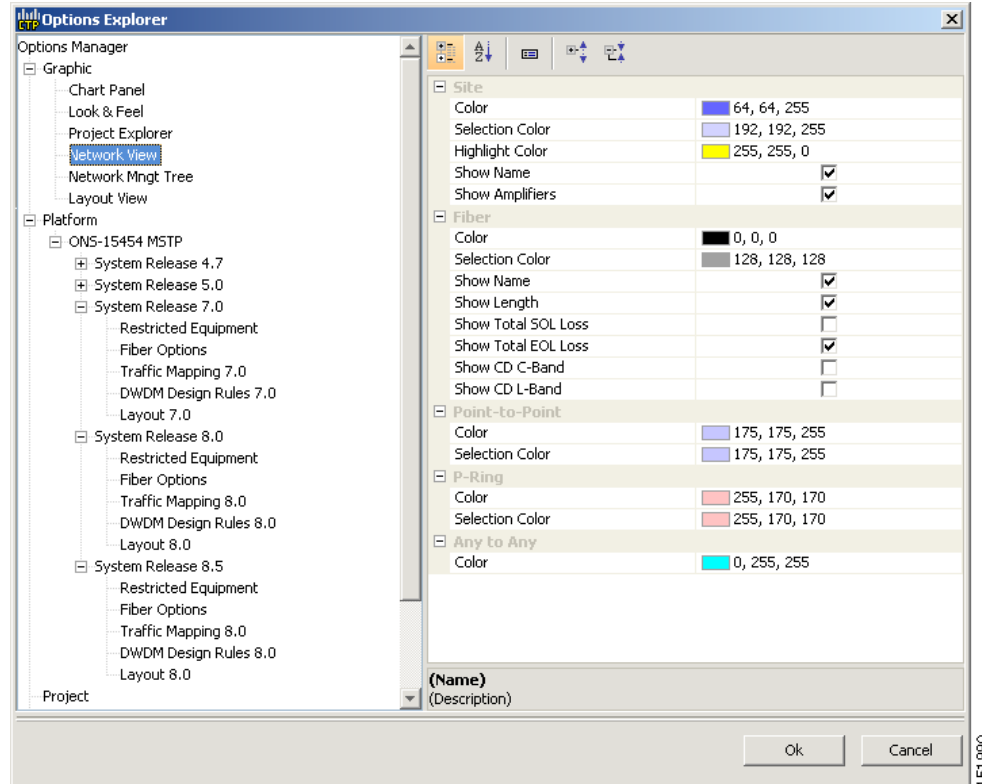

- Step 3** To change the color scheme for Cisco TransportPlanner, click **Look & Feel** and choose the desired scheme from the drop-down list.
- Step 4** To change the appearance of the Project Explorer tree, click **Project Explorer** and complete the following as needed:
- **Overlapping**—Check to reorder sites for a selected network.
  - **Alarm Mode**—Choose **Single** for an alarm icon to report only the condition of that item or **Cumulated** for an alarm icon to summarize the most critical alarm of the item and its children.
  - **Bottom Right Icon**—(Display only) Displays Locking to indicate that the lock icon appears at the bottom right of each locked item in the Project Explorer.
  - **Top Right Icon**—(Display only) Displays Alarm to indicate that the alarm icon appears at the top right of each alarmed item in the Project Explorer. The alarm icon will be green, yellow, orange, or red to indicate the alarm severity.
- Step 5** To change the NtView *Name* tab appearance, click **Network View** and complete the following as needed:
- In the Site area, complete the following:
    - Color, Selection Color, and Highlight Color—To change the site colors, click in the Color, Selection Color, and/or Highlight Color fields in the Site list. Click on the drop-down arrow to display a color swatch popup window. Click the desired color.
    - Show Name—Check to display the site name on the NtView *Name* tab.
    - Show Amplifiers—Check to display the amplifier icon for a site on the NtView *Name* tab.
  - In the Fiber area, complete the following, as needed. Figure 2-7 shows an example of a duct with all of the following details shown.

- Color and Selection Color—To change the fiber color, click in the Color and/or Selection Color fields in the Fibre list and then click the drop-down arrow.
  - Show Spans—Check to display fiber spans on the NtView *Name* tab.
  - Show Length—Check to display fiber length on the NtView *Name* tab.
  - Show total SOL Loss—Check to display start of life (SOL) loss on the NtView *Name* tab.
  - Show total EOL Loss—Check to display end of life (EOL) loss on the NtView *Name* tab.
  - Show CD C-band—Check to display C-band chromatic dispersion (CD) on the NtView *Name* tab.
  - Show CD L-band—Check to display L-band chromatic dispersion (CD) on the NtView *Name* tab.
- To change the color of the traffic demands on the NtView *Name* tab, in the Point To Point, P-Ring, and Any To Any areas click in the Color and Selection Color fields, and then click on the drop-down arrow to display a color swatch popup window. Click the desired color.

**Figure 2-7 Duct Details Shown on the NtView Name Tab**

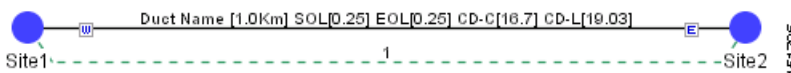

- Step 6** To change the Network Mgmt Tree tab appearance, complete the following as needed:
- In the Network area, click in the Color and Selection fields. Click the drop-down arrow to display a color swatch popup window. Click the desired color.
  - In the Link area, complete the following:
    - To change the link color, click the Color field in the Link list and then click the drop-down arrow. Choose the desired line width from the drop-down list.
    - To change the link appearance, click the Stroke field in the Link list and then click the drop-down arrow. Choose the desired line appearance from the drop-down list.

**Step 7** Click **Ok**.

## 2.2.2 Setting the Default Platform Values

Use the following procedure to establish the default traffic mapping, dense wavelength division multiplexing (DWDM) design, and default layout settings for a particular platform and system release. The default settings will appear during project creation. All the options that you specify can be changed after project creation on a per span basis.

- Step 1** From the Tools menu, choose **Options**.
- Step 2** In the Options Explorer dialog box (Figure 2-6), right-click **Platform** and choose **Expand** from the shortcut menu.
- Step 3** Click the desired **System Release** folder and complete the following as needed:



**Note** Default changes apply only to the specified system release.

- For software R8.5, choose the desired settings in the General area:
  - **Shelf Management**—The options available are Multi Shelf Integrated Switch, Multi Shelf External Switch, and Individual Shelf. These options allow you to specify the type of management to be used for the sites on the network.  
Select **Multi Shelf Integrated Switch** to configure all the Multi Service Transport Platform (MSTP) optical units (OADMs and amplifiers) in different shelves connected together through a LAN. The LAN is implemented with switches plugged into the MSTP shelves.  
Select **Multi Shelf External Switch** to configure all the MSTP optical units (OADMs and amplifiers) in different shelves connected together through a LAN. The LAN is implemented with switches external to the MSTP shelves.  
Select **Individual Shelf** to configure all the MSTP optical units (OADMs and amplifiers) in the same shelf.
  - **Node Protection**—The options available are Same Shelf and Separated Shelves.  
Select **Same Shelf** to configure the optical units (amplifiers and OADM) facing the east side (CW direction) and west side (CCW direction) in the same shelf.  
Select **Separated Shelves** to configure the optical units (Amplifiers and OADM) facing the east side (CW direction) in one shelf and those facing the west side (CCW direction) in a second shelf.
  - **C-band Rules**—Select the options from the drop-down. The options appear in the following format: C 64Chs 50Ghz(+2dBm/Ch). The channels available are 80, 72, 64, 40, 32, 20, 16, and 8; the reference per channel power options available are -1 dBm, -2 dBm, 1 dBm, 2 dBm, 4 dBm, 5 dBm, 7 dBm and 8 dBm; and the spacing options available are 100GHz or 50GHz.
  - **L-band Rules**— Select the options from the drop-down. The options appear in the following format: 32 Ch. 100Ghz +5dBm. The options available are: None, Expand, and channels available are 32; the reference per channel power options available are 2 dBm and 5 dBm; and the only spacing options available is 100GHz.  
Select **Expand** to indicate that the L-band rules as upgradable.
  - **Installation w/o M/P**—Check this box to install network with default parameters. If this option is selected, Cisco TransportPlanner will design the network according to set of predefined conditions, so that the selected node can be installed without the Cisco TransportPlanner configuration files (thresholds and setpoints).
  - **Dithering Lower limit**—This value cannot be lower than 0 and the Dithering Upper Limit cannot be higher than 32.
- For Software R7.0, choose the following in the General area:
  - **C-Band** or **L-Band** as the default band.
  - **Scalable C/L**—(System Release 7.0 only) Check to set scalable C bands and L bands as the default setting during project creation. If checked, the design will be scalable to support both C-band and L-band on the same system.
  - **Scalable C/50GHz**—(System Release 7.0 only) Check to set scalable C-band 50 GHz as the default setting during project creation. If checked, the design will be scalable to support 50-Ghz channel spacing in C-band.
  - **Shelf Management**—The options available are Multi Shelf Integrated Switch, Multi Shelf External Switch, and Individual Shelf. These options allow you to specify the management to be used for the sites of the network.  
Select **Multi Shelf Integrated Switch** to configure all the MSTP optical units (OADMs and

amplifiers) in different shelves connected together through a LAN. The LAN is implemented with switches plugged into the MSTP shelves.

Select **Multi Shelf External Switch** to configure all the MSTP optical units (OADMs and amplifiers) in different shelves connected together through a LAN. The LAN is implemented with switches external to the MSTP shelves.

Select **Individual Shelf** to configure all the MSTP optical units (OADMs and amplifiers) in the same shelf.

- **Node Protection**—The options available are Same Shelf and Separated Shelves.

Select **Same Shelf** to configure the optical units (Amplifiers and OADM) facing the east side (CW direction) and west side (CCW direction) in the same shelf.

Select **Separated Shelves** to configure the optical units (Amplifiers and OADM) facing the East side (CW direction) in one shelf and those facing the west side (CCW direction) in a second shelf.

- Step 4** Click the **Restricted List** folder. To restrict a card, check the check box in the Restricted column for that card.

To change the setting back to unrestricted, uncheck the check box. To apply restricted list changes to an open project, complete the following:

- a. Right-click the folder for the network that you want to update and choose **Expand** from the shortcut menu.
- b. Right-click the desired platform and release folder under RestrictedEqptListFolder in the Project Explorer and choose **Edit List** from the shortcut menu. The Restricted Equipment list for MSTP 454 DWDM[Release Number] dialog box appears.
- c. Click **Update**.
- d. Click **Ok** to close the dialog box.

- Step 5** Enter the **Fiber Options** details.

- Span Label Tag—Enter the desired span label; the default label is Duct.
- Span Length—Enter the span length. The displayed unit of measure is retrieved from the Span Measurements Units field.
- EOL Ageing loss [dB]—Enter the EOL aging loss value. The EOL loss-per-span value is added at the end of life to each discrete fiber in the network (for example, to add an EOL margin for splicing).
- EOL Ageing Factor—Enter the number to use when factoring fiber aging. This factor is multiplied by the SOL total span loss without connectors.



---

**Note** Enter a value in either EOL Ageing Factor or EOL Ageing loss; you do not need to enter a value in both fields.

---

- Connector loss [dB]—Enter the concentrated loss at the end of the span.
- Length Based Loss—If checked, the fiber loss is determined by multiplying the Span Length by the Loss Factor. If the check box is not checked, you must enter the total loss of the span.
- Tot SOL loss w/o conn [dB]—Enter the start of life link fiber loss for each span, without the connector concentrated loss. The total SOL loss without connectors is equal to the loss factor multiplied by the length. In the Length Based model, this value is calculated automatically.
- DCN Extension (With Software R8.5 Only)—Click the check box to enable the default use of data connection network (DCN) extension on each span in the project. This implies that the OSC channel is not used to connect the two nodes. This default can be overridden on the network wizard pane.



**Note**

Use one of the following formulas to calculate the fiber loss at SOL:

$$\text{SOL} = \text{km} * \text{dB/km} + (2 * \text{connector loss})$$

$$\text{SOL} = \text{user entered loss} + (2 * \text{connector loss})$$

Use one of the following formulas to calculate the fiber loss at EOL:

$$\text{EOL} = \text{km} * \text{dB/km} * \text{EOL Aging Factor} + (2 * \text{connector loss}) + \text{EOL Aging Loss, or}$$

$$\text{EOL} = \text{user entered loss} * \text{EOL Aging Factor} + (2 * \text{connector loss}) + \text{EOL Aging Loss}$$

- Select the **Fiber Type** of each span of the network. You can specify a fiber type even if the fiber type is not supported for the design.

**Step 6** Click the **Traffic Mapping** folder and complete the following as needed.

- In the Fixed traffic area, choose the unprotected routing strategy from the drop-down list:
  - Auto
  - Unprotected optimum optical path—Each node pair is connected using one connection. The unprotected optimum optical path minimizes the number of required optical amplifiers.
  - Unprotected minimum hop count—Each node pair in the traffic group is connected by one connection. The unprotected minimum hop count minimizes the number of channels (for unprotected traffic types only) that can be deployed among the nodes of the traffic group.

**Step 7** Select the C-band and L-band rules.

- **C-band Rules**—Select the options from the drop-down. The options appear in the following format: C 64Chs 50Ghz(+2dBm/Ch). The channels available are 80, 72, 64, 40, 32, 20, 16, and 8; the reference per channel power options available are -1 dBm, -2 dBm, 1 dBm, 2 dBm, 4 dBm, 5 dBm, 7 dBm and 8 dBm; and the spacing options available are: 100GHz or 50GHz.
- For **L-band Rules**— Select the options from the drop-down. The options appear in the following format: 32 Ch. 100Ghz +5dBm. The options available are: None, Expand, and channels available are 32; the reference per channel power available are 2 dBm and 5 dBm; and the spacing options available is 100GHz.  
Select **Expand** to indicate the L-band rules as upgradable.

**Step 8** Click the **DWDM Design Rules** folder and complete the following as needed:

- No Tilt Design—Check to force Cisco TransportPlanner to operate the amplifiers inside the gain range where no tilt is generated and to determine the type and number of amplifiers in each site of the network accordingly. This option sets all the intermediary points of the network so that channels are always at the reference power level. Default value is Disabled.



**Note** Long spans (with insertion loss greater than 25 dB) might not be supportable.

- No In-line Bulk Attenuator Design—Check to design the network without using any inline bulk attenuators. In case the network cannot be designed without using external in-line attenuators, Cisco TransportPlanner displays the following error message: “Unfeasible Network design. Site X should require usage of in-line attenuator. Leave unchecked to allow inline bulk attenuators.”
- No TXT/Line-Card Bulk Attenuator Design—Check to design the network without using any external receive (Rx) bulk attenuators on transponder or line cards. If any of the clients require Rx bulk attenuators, then the related channel is shown with the working condition (flagged red, orange, or yellow). No Rx bulk attenuator will be shown in any of the reports (such as Optical Channel Results, Internal Connections, or BoM). Leave unchecked to allow bulk attenuators.

- Prevent Use of E-LEAF Dispersion—Check to prevent Cisco TransportPlanner from using E-LEAF dispersion compensation units (DCUs) on E-LEAF spans for the overall network. Leave unchecked if you want the algorithm to automatically optimize the usage of the E-LEAF DCUs.
- OSNR Alarm For Regeneration—This option allows you to define the optical signal-to-noise ratio (OSNR) alarm severity. When this limit is reached, Cisco TransportPlanner suggests channel at an appropriate site on the network. After the network is designed and analyzed, in the Tasks pane (under Reports), click **Optical Results** to see if any site requires regeneration. The regeneration column will suggest the site where Regeneration is required.
- Turbo Simplex—Check to achieve faster results by optimizing a subset of the total channels based on type and path rather than optimizing each and every channel. Deselecting can result in longer analysis times for large networks, especially with Any-to-Any ROADM traffic.
- Max Sc Value—This option allows you to enter the maximum slope compensation value.

**Step 9** To define the shelf configuration parameters, click the **Layout** folder and complete the following:

- Osmine Compliant—Check to instruct Cisco TransportPlanner to ensure that all the sites placing Transponder and Line Cards are compliant with OSMINE.
- Hybrid Node—Check to instruct Cisco TransportPlanner to ensure that cross-connect, SDH, and SONET cards not placed within the optical transport section (OTS) shelf.
- Max Number of Shelves—This option allows you to specify the maximum number of shelves per rack. Default is Auto and the maximum number of shelves you can specify is 4.
- AIC—Select Yes to instruct Cisco TransportPlanner to put the AIC card in Slot 9 of the first shelf in each site.
- FiberStorage—Select Yes to instruct Cisco TransportPlanner to put the fiber storage within the rack below the optical shelf.
- Y-Cable—The options available are Auto, 1RU FlexLayer Shelf Assembly, and 2RU Y-Cable Panel.
  - Auto—Instructs Cisco TransportPlanner to set the default value for the Y-Cable option.
  - 1RU FlexLayer Shelf Assembly—Instructs Cisco TransportPlanner to use the ONS 15216 Splitter/Combiner Flex Layer modules to implement the required Y-cable protections.
  - 2RU Y-Cable Panel—Instructs Cisco TransportPlanner to use the new ADC Splitter/Combiner modules to implement the required Y-cable protections.
- FanTry—(Software R8.5 only) Instructs Cisco TransportPlanner to put the type of fan tray within each node. Options available are: FTA-3-T or FTA 4-T.
- DCC Shelves Management—Check to instruct Cisco TransportPlanner to reserve Slot 12 for equipping 15454-MR-L1 unit to implement data communication channel (DCC) Shelves Management.

**Step 10** Click **OK**.

## 2.2.3 Setting the Default Project Values

Use the following procedure to set the default project settings and repair time. These defaults will appear during project creation.

**Step 1** From the Tools menu, choose **Options**.

- Step 2** In the Options Explorer dialog box (Figure 2-6 on page 2-19), click **Project** and complete the following to set the defaults that appear in the Project Creation wizard:
- Customer—Enter the default customer name (128 character maximum).
  - Created by—Enter the default user name (128 character maximum).
  - Units—Choose the desired default span length unit of measure from the drop-down list, either **Km** or **Miles**.
  - Price List—Choose the desired default price list.
  - Layout—Choose either **ANSI** (American National Standards Institute) or **ETSI** (European Telecommunications Standards Institute) from the drop-down list.
- Step 3** Click **General** and complete the following:
- MTTR (hours)—Enter the mean time to repair (MTTR) for all sites in the network. This will apply to every site in the network. If you change the MTTR value after creating sites, the new value will only apply to sites you create after the change.
  - Restocking Time (days)—Enter the number of days required (including transportation time) to restock the units into the maintenance center.
  - Confidence Level (%)—Choose the confidence level for finding the spare units in the maintenance center (50, 75, 95, or 99 percent).
- Step 4** Click **Ok**.

## 2.2.4 Defining Third-Party DWDM Interfaces

Cisco TransportPlanner allows you to define a third-party DWDM interface to be used in project creation. After you define third-party DWDM interfaces, you can choose them when creating traffic demands. For more information on defining third-party interfaces, see [Appendix D, “Third-Party DWDM Wavelength Interface Model”](#).



### Note

If you create a network design with a third-party interface and need to share the design with other users, you must provide not only the saved network MPZ file but also the exported database file containing the third-party interface definition. To view this project, the other user first must import the database with the third-party interface values.

Use the following procedure to define a third-party DWDM interface:

- Step 1** Click **Tools > DB Parts Mgmt**. The DB Parts Manager dialog box appears.



### Note

You cannot open the DB Parts Manager if a project is open or if you are using the Base Network Designer profile.

- Step 2** Right-click **Platform Parts** and choose **Expand** from the shortcut menu.
- Step 3** Right-click **Group** and choose **New Group** from the shortcut menu. The new group appears under Group and in each system release under parts DB.
- Step 4** In the Group Editor dialog box, complete the following:

- Name of group—Enter the name of the new database.
  - Note—(Optional) Enter a description of the group.
- Step 5** In the parts DB for the desired system release, click the group that you created.
- Step 6** In the Parts tab of the DB Parts Manager dialog box, right-click and choose **Client** and then **Alien** from the shortcut menu. A new row appears on the Parts tab for the client hardware.
- Step 7** Double-click the row to open the Alien dialog box (Figure 2-8).

**Figure 2-8 Alien Card Dialog Box**

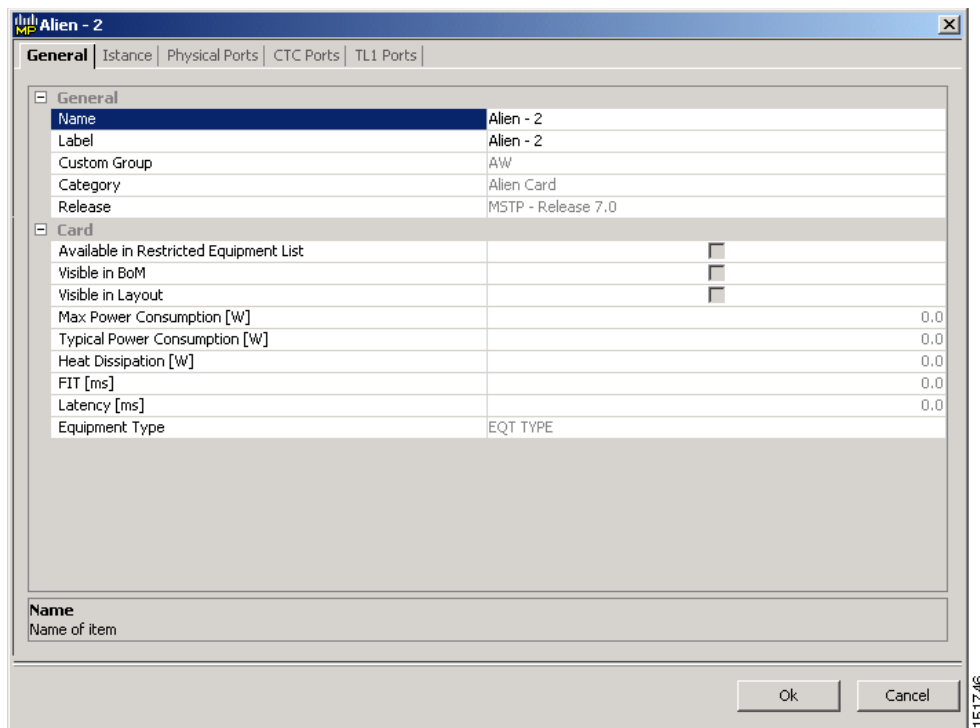

- Step 8** In the General tab of the Alien dialog box, type the name of the card in the **Name** field and the enter the **Label** name.
- Step 9** Click the **Instance** tab and complete the following:
- Ansi PID—Enter the product identifier of the ANSI system, as needed. If you select BoM visible for this third-party interface with ANSI PID completed, the third-party interface is included in the BoM with the related product identifier.
  - Etsi PID—Enter the product identifier of the ETSI system, as needed. If you select BoM visible for this third-party interface with ETSI PID completed, the third-party interface is included in the BoM with the related product identifier.
  - TAG—(Display only) For internal use.
  - SYS. NAME ANSI—Not applicable for third-party interfaces.
  - SYS. NAME ETSI—Not applicable for third-party interfaces.
  - WL START—Choose the wavelength starting range that the third-party interface supports from the drop-down list.
  - WL END—Choose the wavelength ending range that the third-party interface supports from the drop-down list.

- Step 10** Click the **Physical Ports** tab and in the Label column, type a label for each port.  
The CTC Ports and TL1 Ports tabs are not applicable for third-party interfaces.
- Step 11** Click **Ok**.
- Step 12** In the Parts tab of the DB Parts Manager dialog box, right-click and choose **Software** and then **Alien** from the shortcut menu. A new row appears on the Parts tab for the client software.
- Step 13** Double-click the row to open the AlienSoft dialog box.
- Step 14** In the General tab, complete the following:
- Name—Type the name in the Name field.
  - Related Item—Choose the client card that you created in [Step 7](#) to [Step 11](#).
- Step 15** Click the **Default - OCh** tab ([Figure 2-9](#)).

**Figure 2-9 AlienSoft Dialog Box, Default-OCh Tab**

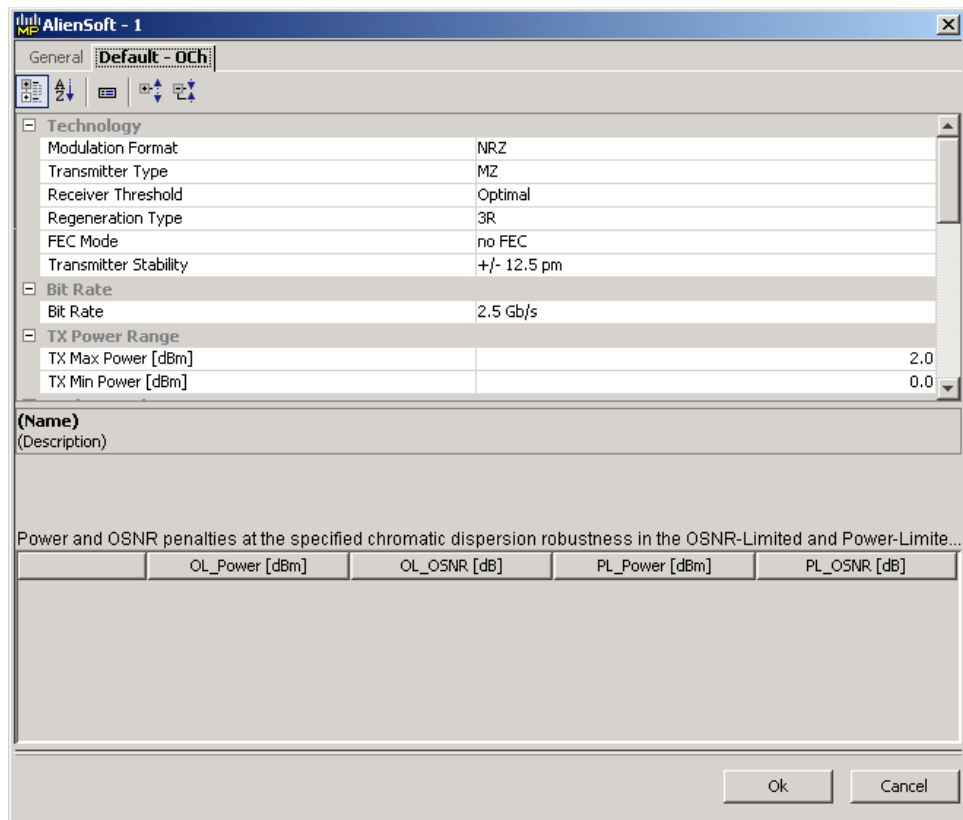

- Step 16** Complete the following (see [Tables 2-1](#) through [2-3](#) for supported value combinations):
- In the Rules area, choose the C- or L-band design rule from the **Design Rule** drop-down list.
  - In the Technology area, complete the following:
    - Modulation Format—Choose **NRZ** (Non Return to Zero) or **Duo Binary**.
    - Transmitter Type—Choose **MZ** (Mach Zehnder), **DML** (Direct Modulated Laser), or **EML** (Electro-absorption Modulated Laser).
    - Receiver Threshold—Choose **Optimal** (minimum BER) or **Average** (average received power).
    - Regeneration Type—Choose **3R** or **2R** regeneration mode.

- FEC Mode—Choose **FEC** (Forward Error Correction), **no FEC**, or **E-FEC** (Enhanced FEC).
- Transmitter Stability—Choose the maximum wavelength error allowed (pm). The values are 12.5, 25, 50, or 100 pm.
- Bit Rate—Choose the desired bit rate from the drop-down list.
- In the TX Power Range area, complete the following:
  - TX Max Power—Enter the maximum power output level (dBm).
  - TX Min Power—Enter the minimum power output level (dBm).
- In the Back to Back Receiver Sensitivity area, complete the following as needed to define the working interface area for Back to Back. Back to Back is a configuration where the receiver is placed in front of the transmitter and no other equipment exists between the two. Back to Back is used to measure characteristics of the TX and RX pair. [Figure 2-10](#) shows the interface operative area.
  - Overload Power [ps/nm]—Enter the overload power level.
  - OL\_Power [dBm]—Enter the minimum power level in the OSNR-limited range.
  - OL\_OSNR [dB] on 0.5 nm RBW—Enter the minimum OSNR level in the OSNR-limited range (measured in 0.5 increments).
  - PL\_Power [dBm]—Enter the minimum power level in the power-limited range.
  - PL\_OSNR [dB] on 0.5 nm RBW—Enter the minimum power level in the OSNR-limited range (measured on 0.5 nm bandwidth).
- In the Chromatic Dispersion area, complete the following as needed:
  - Customize CD Robustness—Check to enable the CD Robustness field, as needed. Chromatic dispersion (CD) refers to the broadening of a light pulse after traveling a distance in the fiber.
  - CD Robustness [ps/(nm\*km)]—If Customize CD Robustness is checked, choose the maximum positive dispersion, Dmax\_pos [ps/(nm\*km)], tolerable by the interface: 0dB, 1dB, 1.5dB, 2dB, or 3dB.
- Customize Penalties—Check to enable the Gaussian cross-talk Penalties, Single-Interfering Cross-Talk Penalties, and Scale Q factors fields as needed.
- If Customize Penalties is checked, enter the values to determine the Gaussian cross-talk Penalties in the A\_GXt and B\_GXt fields, as needed. Gaussian cross talk refers to random power that interferes with a signal. The A\_GXt and B\_GXt values are the coefficients for the exponential curves that estimate P-penalty (PL), P-penalty (OL), OSNR-penalty (PL), and OSNR-penalty (OL) for Gaussian cross-talk levels in the OL and PL regions of the interface model with dispersion margins added (see [Figure 2-10](#)). The formula is  $\text{Penalty (GXt)} = A\_GXt * \exp(B\_GXt * GXt)$ .
- If Customize Penalties is checked, enter the values to determine the Single-Interfering Cross-Talk Penalties in the A\_SIXt and B\_SIXt fields, as needed. Single-interfering cross talk refers to interference caused by a single signal. The A\_SIXt and B\_SIXt values are the coefficients for the exponential curves that estimate P-penalty (PL), P-penalty (OL), OSNR-penalty (PL), and OSNR-penalty (OL) for single-interfering cross-talk in the OL and PL regions of the interface model with dispersion margins added (see [Figure 2-10](#)). The formula is  $\text{Penalty (IXt)} = A\_SIXt * \exp(B\_SIXt * IXt)$ .
- If Customize Penalties is checked, enter Scale Q values in the F-P(PL), F-P(OL), F-OSNR(PL), and F-OSNR(OL) fields, as needed. The scale factors measure how efficient a card is in recovering the signal distortion. The slope of the Q-factor curve versus OSNR or RX power determines how a BER increase could be recovered with an increase of OSNR, power, or both (depending in which OSNR/power working point the card is). In general, the scale factors are two values (one in OSNR

and one in power) for each working point OL and PL of the interface model (see Figure 2-10). The the F-P(PL), F-P(OL), F-OSNR(PL), and F-OSNR(OL) values translate a Q-penalty (that is, a BER increase) into power and OSNR penalties. The formulas follow:

- $P\text{-penalty}(PL) = Q\text{-penalty} * F\text{-P}(PL)$
- $P\text{-penalty}(OL) = Q\text{-penalty} * F\text{-P}(OL)$
- $OSNR\text{-penalty}(PL) = Q\text{-penalty} * F\text{-OSNR}(PL)$
- $OSNR\text{-penalty}(OL) = Q\text{-penalty} * F\text{-OSNR}(OL)$

F-P(PL) and F-OSNR(PL) are evaluated in the PL working region, while F-P(OL) and F-OSNR(OL) are evaluated in the OL working region of the curve with the dispersion margins added.

**Figure 2-10 Interface Operative Area**

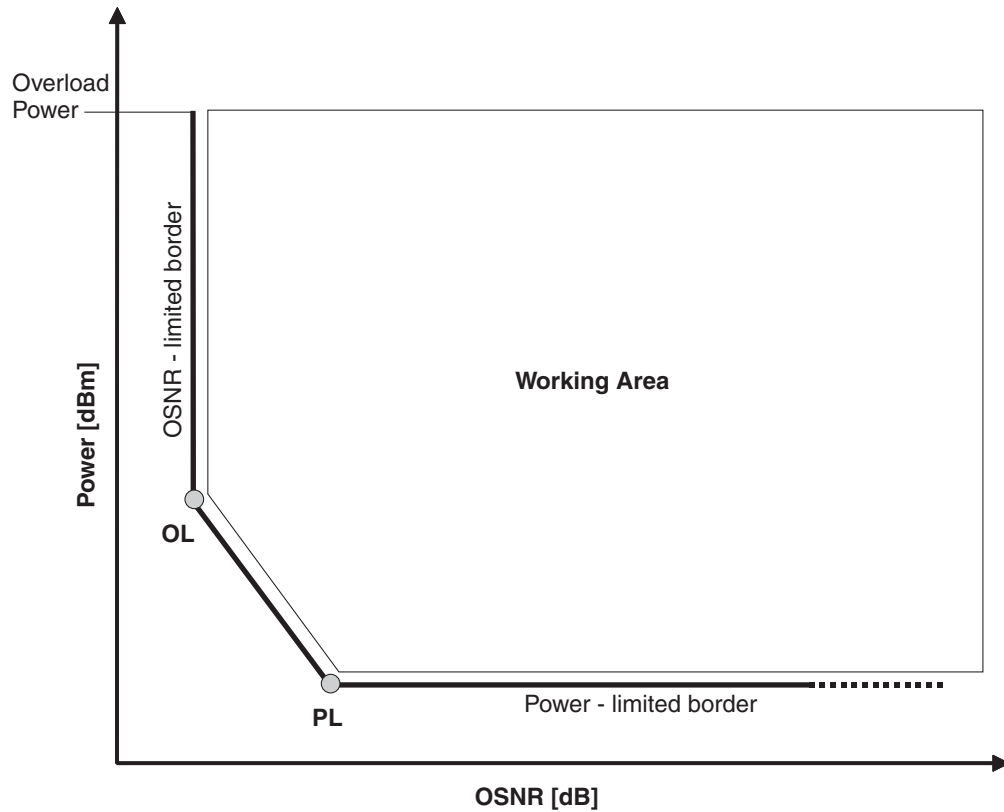

151731

**Step 17** Click **Ok**.

Table 2-1 lists the supported combinations for 40-Gbps third party interfaces.

**Table 2-1 Supported Combination for 40-Gbps Third-Party Interface**

| Modulation Format | TX Type | RX Threshold | FEC   | TX Stability [pm] | Chromatic Dispersion Penalties [dBm] |                   |                |                   |
|-------------------|---------|--------------|-------|-------------------|--------------------------------------|-------------------|----------------|-------------------|
|                   |         |              |       |                   | P-penalty (OL)                       | OSNR-penalty (OL) | P-penalty (PL) | OSNR-penalty (PL) |
| Duo Binary        | MZ      | Optimal      | E-FEC | ± 12              | 0                                    | 1                 | 0              | 1                 |

Table 2-2 lists the supported combinations for 10-Gbps third party interfaces.

**Table 2-2 Supported Combinations for 10-Gbps Third-Party Interface**

| Modulation Format | TX Type | RX Threshold | FEC    | TX Stability [pm] | Chromatic Dispersion Penalties [dBm] |                   |               |                   |
|-------------------|---------|--------------|--------|-------------------|--------------------------------------|-------------------|---------------|-------------------|
|                   |         |              |        |                   | P-penalty (OL)                       | OSNR-penalty (OL) | P-penalty(PL) | OSNR-penalty (PL) |
| NRZ               | MZ      | Optimal      | E-FEC  | ± 25              | 0                                    | 2                 | 1             | 0                 |
| NRZ               | MZ      | Optimal      | FEC    | ± 25              | 0                                    | 1.5               | 1             | 0                 |
| NRZ               | MZ      | Average      | no FEC | ± 25              | 2                                    | 0                 | 2             | 0                 |
| NRZ               | EML     | Average      | no FEC | ± 100             | 0                                    | 3                 | 3             | 0                 |

Table 2-3 lists the supported combinations for 2.5-Gbps third party interfaces.

**Table 2-3 Supported Combinations for 2.5-Gbps Third-Party Interface**

| Modulation Format | TX Type | RX Threshold | FEC    | TX Stability [pm] | Chromatic Dispersion Penalties [dBm] |                   |                |                   |
|-------------------|---------|--------------|--------|-------------------|--------------------------------------|-------------------|----------------|-------------------|
|                   |         |              |        |                   | P-penalty (OL)                       | OSNR-penalty (OL) | P-penalty (PL) | OSNR-penalty (PL) |
| NRZ               | DML     | Average      | FEC    | ± 25              | 0                                    | 2                 | 2              | 0                 |
| NRZ               | DML     | Average      | no FEC | ± 25              | 0                                    | 2                 | 2              | 0                 |
| NRZ               | DML     | Average      | no FEC | ± 25              | 3                                    | 0                 | 3              | 0                 |
| NRZ               | DML     | Average      | no FEC | ± 25              | 3                                    | 3                 | 3              | 3                 |
| NRZ               | EML     | Average      | no FEC | ± 25              | 0                                    | 2                 | 2              | 0                 |
| NRZ               | DML     | Average      | no FEC | ± 100             | 0                                    | 3                 | 3              | 0                 |

## 2.2.5 Exporting a File

Use the following procedure to export user options, price lists, maintenance contracts, and the parts database files. The export command creates a ZIP file that includes all of the created files.

- Step 1** From the Tools menu, choose **Export**. The Export dialog box appears (Figure 2-11).



Figure 2-11 Export Dialog Box

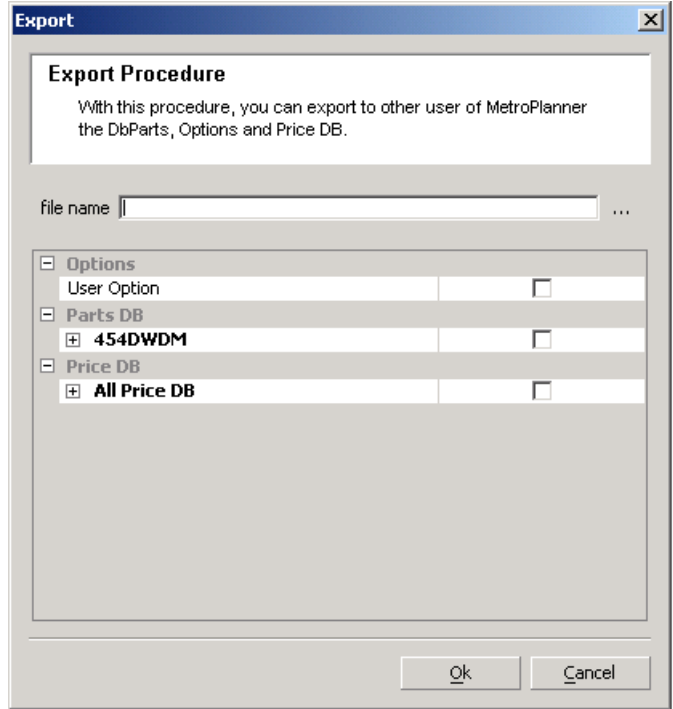

- Step 2** In the Export dialog box, enter a file path and name in the file name field. To export to an existing file, click the ... button and navigate to the desired directory and file. Click **Select** to choose the file.
- Step 3** To select the items to export, complete the following as needed:
- User Option—Check to export the user options set using the Tools > Options command.
  - PartsDB—Check the desired platforms.
  - PriceDB—Check **All Price DB** to export all price lists, or expand All Price DB and check the individual price lists that you want to export.
- Step 4** Click **Ok**.

## 2.2.6 Importing a File

Use the following procedure to import user options, price lists, maintenance contracts, and the parts database files. You can import a ZIP file of multiple exported items or an individual TXT file.

- Step 1** From the Tools menu, choose **Import**. The Import dialog box appears (Figure 2-12).

Figure 2-12 Import Dialog Box

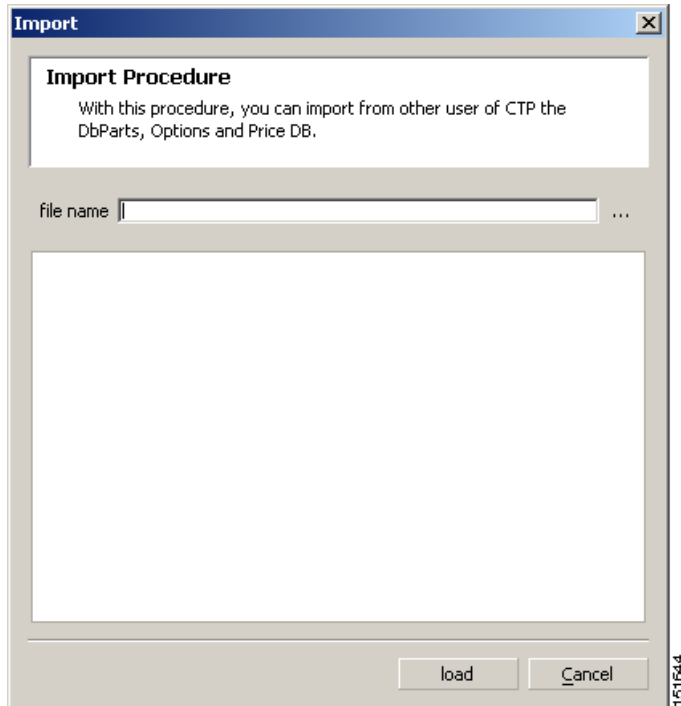

- Step 2** In the Import dialog box, click the ... button and navigate to the desired directory and file. Click **Select** to choose the file to import.
- Step 3** Click **load**.
- Step 4** If you selected a single TXT file, skip this step and go to [Step 5](#). If you selected a ZIP file with multiple exported options, complete the following as needed:
- User Option—Leave checked to import a file with the user options that were set with the Tools > Options command.
  - PartsDB—Leave checked to import the parts database for the desired platform.
  - PriceDB—Leave **All Price DB** checked to import all price lists, or uncheck and check the desired individual price lists.
- Step 5** Click **OK**.
- Step 6** In the confirmation dialog box, click **OK**.

## 2.2.7 Resetting the Default Layout

Your graphical layout settings are saved when you exit Cisco TransportPlanner. The next time that you launch Cisco TransportPlanner, the layout appears as it did upon exiting. The default graphical layout includes items such as whether the panes are visible and/or docked.

To return to the Cisco TransportPlanner default layout, choose **Default Layout** from the View menu. To restore the user modified layout, choose **My Default View** from the View menu.

## 2.2.8 Adding Plug-ins

Use the following procedure to add plug-ins to Cisco TransportPlanner. Plug-ins are released separately from Cisco TransportPlanner by Cisco Systems. Using plug-ins, you can customize the released version of Cisco TransportPlanner.

- Step 1** Copy the plug-in file into the Documents and Settings\*username*\Desktop\CTP\_8.5.0\plugins folder.
- Step 2** From the File menu, choose **Exit**, then click **Yes** or **No** to save the existing project.
- Step 3** Launch Cisco TransportPlanner. For more information, see the “[2.1 Launching Cisco TransportPlanner](#)” section on page 2-14.
- Step 4** Choose **Tools > Plug-In > View Plugin registry**. The PlugIn Registry dialog box appears ([Figure 2-13](#)).

**Figure 2-13** PlugIn Registry Dialog Box

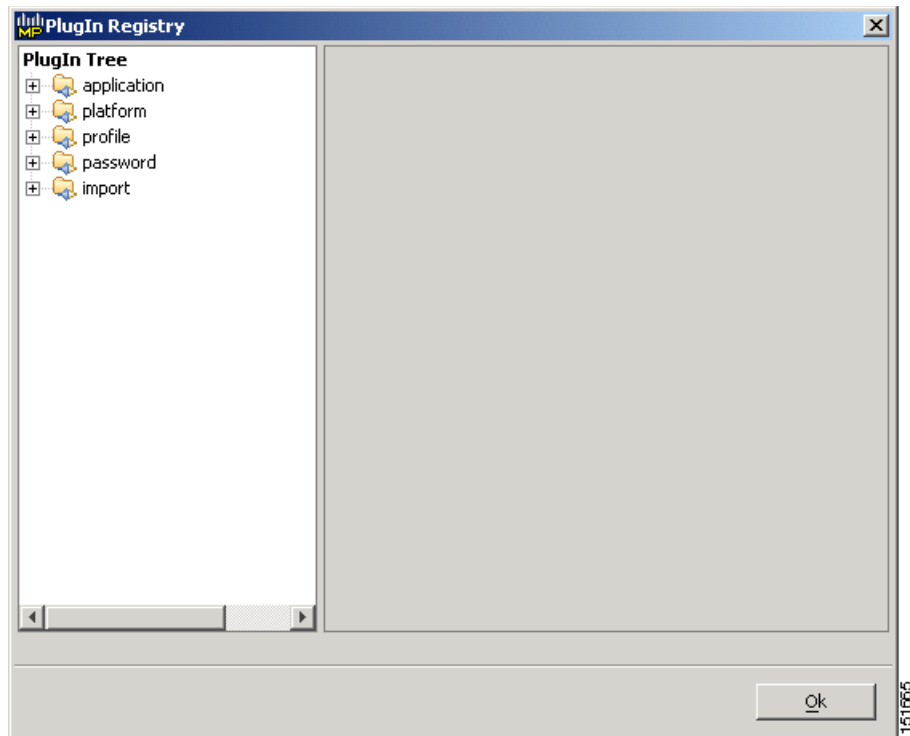

- Step 5** In the PlugIn Tree, right-click the new plug-in folder and choose **Expand** from the shortcut menu.
- Step 6** Two categories of plug-in are defined in the tool:
  - Plug-in that cannot be deactivated—These plug-ins have the parameter “Can be deactivated = FALSE”. They are loaded at Cisco TransportPlanner startup and no action is available.
  - Plug-in that can be deactivated - These plug-ins have the parameter “Can be deactivated = TRUE.” These plug-ins support two additional parameters:
    - Can be suspended—When set to TRUE, an additional action on the plug-in allows you suspend or resume the plug-in within the current Cisco TransportPlanner running session.
    - Can be stopped—When set to TRUE, the user decides if the plug-in will or will not run the next time Cisco TransportPlanner is started.
- Step 7** Click the plug-in and set the desired action—Deactive, suspended, or stopped.

**Step 8** Close Cisco TransportPlanner and restart. The plug-in action set in the procedure to takes affect.

---

## 2.2.9 Managing Plug-ins

Use the following procedure to view and manage plug-ins. For information about adding plug-ins, see [“2.2.8 Adding Plug-ins” section on page 2-33](#).

**Step 1** Choose **Tools > Plug-In > View Plugin registry**. The PlugIn Registry dialog box appears ([Figure 2-13 on page 2-33](#)).

**Step 2** In the PlugIn Tree, right-click the plug-in folder and choose **Expand** from the shortcut menu.

**Step 3** Click a plug-in to view information about it. The right pane of the PlugIn Registry dialog box displays the plug-in information.

- The General area of the PlugIn Registry dialog box identifies the following information:
  - Name—(Display only) Displays the name of the plug-in.
  - Path—(Display only) Displays the location of the plug-in.
  - Version—(Display only) Displays the version of the plug-in.
  - Provider—Displays the name of the supplier of the plug-in.
  - Text—(Display only) Displays a brief description of the plug-in.
  - Exclusion—(Display only) Displays the exclusion label. The exclusion attribute is a tag that defines an exclusion rule for a plugin. No more that one plugin with a given exclusion tag can be run at the same time.
- The State area of the PlugIn Registry dialog box identifies the plug-in current state and restrictions:
  - Current State—(Display only) Identifies the state of the plug-in.
  - Can be stopped—(Display only) If TRUE, you can disable the plug-in during the current session of Cisco TransportPlanner. The plug-in will disappear from the File menu. To restart a plug-in that has been stopped, you must exit and relaunch Cisco TransportPlanner. If FALSE, you cannot stop the plug-in during an active Cisco TransportPlanner session.
  - Can be suspend—(Display only) If TRUE, you can disable the plug-in during the current session of Cisco TransportPlanner. The plug-in will disappear from the File menu. To restart a plug-in that has been suspended, you can choose Resume in the PlugIn Registry dialog box. It is not necessary to exit and relaunch Cisco TransportPlanner. If FALSE, you cannot suspend and resume this plug-in during an active Cisco TransportPlanner session.
- The Run Information area of the PlugIn Registry dialog box displays the Can be deactivated state. If TRUE, you can deactivate a plug-in but must exit and relaunch Cisco TransportPlanner for the deactivation to take effect. When you relaunch Cisco TransportPlanner, the plug-in will not appear in the File menu. If FALSE, you cannot deactivate this plug-in.

**Step 4** To disable or suspend a plug-in, right-click the plug-in and choose one of the following from the shortcut menu:

- Do not run at start—Choose to disable the plug-in the next time Cisco TransportPlanner is launched.
- Suspend/Resume—Choose **Suspend** if you want to disable the plug-in immediately without restarting Cisco TransportPlanner. Choose **Resume** to enable a suspended plug-in.

**Step 5** Click **Ok**.

- Step 6** In the confirmation dialog box, click **Ok**.
- Step 7** If you chose Do not run at start, exit and relaunch Cisco TransportPlanner for the plug-in to be disabled.
- 

## 2.2.10 Adding User Profiles

A user profile is a set of privileges used for running Cisco TransportPlanner. Each profile offers different capabilities. Cisco TransportPlanner is packaged with the Network Designer profile, but you can add other user profile types provided by Cisco. All the procedures in the *Cisco TransportPlanner DWDM Operations Guide* are written for users with Network Designer access.

Use the following procedure to add a user profile to Cisco TransportPlanner:

- 
- Step 1** Close all open instances of Cisco TransportPlanner.
- Step 2** Identify the directory where Cisco TransportPlanner is installed on your computer, see the [“2.1 Launching Cisco TransportPlanner”](#) section on page 2-14.
- Step 3** Create a profile folder; if profile folder already exists, go to [Step 4](#).
- Step 4** Copy the profile JAR file provided by Cisco Systems into the profile folder.
- Step 5** Launch Cisco TransportPlanner. For more information, see the [“2.1 Launching Cisco TransportPlanner”](#) section on page 2-14. The new profile will appear in the **Current Selected Profile** drop-down list.
- 

## 2.2.11 Running a Script

Use the following procedure to run a script. A script is a sequence of commands in a BSH file format that is used to provide additional Cisco TransportPlanner capabilities. Cisco provides valid scripts to help you customize your Cisco TransportPlanner software.



---

**Note** You must have received a valid script from Cisco Systems before you can perform this procedure.

---

- Step 1** From the Script menu, choose **Run Script**.
- Step 2** In the Choose the script to run dialog box, click the desired script and click **Open**. The script runs.
- Step 3** To run a script again, choose **Run Again > script-name**.
- 

## 2.2.12 Refreshing the Script Menu

Common scripts, located in the Cisco TransportPlanner scripts directory, displayed in the Script > Common menu and can be run by any user. User scripts, located in the C:/Documents and Settings/user-home/CTP\_version/scripts, are displayed in the Script> User menu.

Any time you add or remove a script from one of these directories, you must choose **Refresh Dirs** so that the changes appear on the Script menu. The Remove Dirs command removes script names from the Script > Run Again menu and updates the Script > Common and User menus.

## 2.2.13 Understanding Sides Labeling

In Cisco TransportPlanner Software R8.5, the label for each supported site structure is different from the labels that have been used in the previous releases. [Table 2-4](#) summarizes the labeling format of the sites in the previous releases and in Cisco Transport Planner Software R8.5.

**Table 2-4** Sides Labeling in Cisco Transport Planner Software R8.5 and in previous releases

| Sites                       | Labeling in Previous Releases                         | Labeling in Cisco Transport Planner Software R8.5                         |
|-----------------------------|-------------------------------------------------------|---------------------------------------------------------------------------|
| Terminal/Terminal+          | Only one side is created and labeled, T.              | Only A can be used for the existing side.                                 |
| Line/Line+                  | Two sides are created and are labeled, West and East. | Only A and B can be used for the existing sides.                          |
| Multi-Degree with PP-MESH-4 | —                                                     | Only A, B, C, and D can be used for the existing sides.                   |
| Multi-Degree with PP-MESH-8 | —                                                     | Only label A, B, C, D, E, F, G, and H can be used for the existing sides. |

## 2.3 Creating a Project

A project consists of a single network or multiple networks that you analyze and compare. In a project, you can have multiple copies of a single network with the same customer input data, but use different options in each to investigate multiple solutions.

Use the following procedure to create a single network in a project. A new network is in the Design state. For more information about the different network states, see the [“2.7 Managing the Network Design”](#) section on page 2-126.



### Note

All options set by the Project Creation Wizard can be changed as needed, except Measurement Units and ANSI/ETSI, which can be changed.

**Step 1** From the File menu, choose **New**. The Project Creation Wizard appears ([Figure 2-14](#)).

Figure 2-14 Project Creation Wizard

- Step 2** On the Project page, complete the following:
- **Created By**—Displays the user login name. You can edit this field (128 character maximum).
  - **Customer Name**—Type the name of the customer (128 character maximum) requiring this network design.
  - **Network Platform Layout**—Choose **ANSI** (the North American standard) or **ETSI** (the international standard) from the drop-down list to indicate the platform type. ANSI networks will not allow you to define SDH (ETSI) service demands. ETSI networks will not allow you to define SONET (ANSI) service demands.
  - **Span Measurement Units**—Choose **Km** (kilometers) or **Miles** from the drop-down list to set the unit of measure used for span length.
  - **Price List**—Choose the price list from the drop-down list.
- Step 3** Click **Next**.
- Step 4** On the Platform page, check the desired platform and click **Next**.
- Step 5** On the Release page, check the desired software release for the network design and click **Next**. The default is the latest release. This attribute defines the list of hardware parts that can be used in the design because they are supported in this release.
- Step 6** On the Subnet page, complete the following (Figure 2-15):
- **Traffic Mapping Algorithm Release 8.5**—Check to select the ONS 15454 Software R8.5 version of the interface and the wavelength routing optimization algorithm to be used in the network design. Software R8.5 is backward compatible and can manage Software Releases 4.7, 5.0, 7.0, and 8.5.
  - **Design Design Rules Release 8.5**—Check to select DWDM Design Rules Release 8.5.

- **Layout Release 8.5**—Check to define the ONS 15454 Software R8.5 version of the algorithm used to generate the layout of each site within the subnetwork. Software R8.5 is backward compatible and can manage Software Releases 4.7, 5.0, 7.0, and 8.5.

**Figure 2-15** Project Creation Wizard Subnet Page

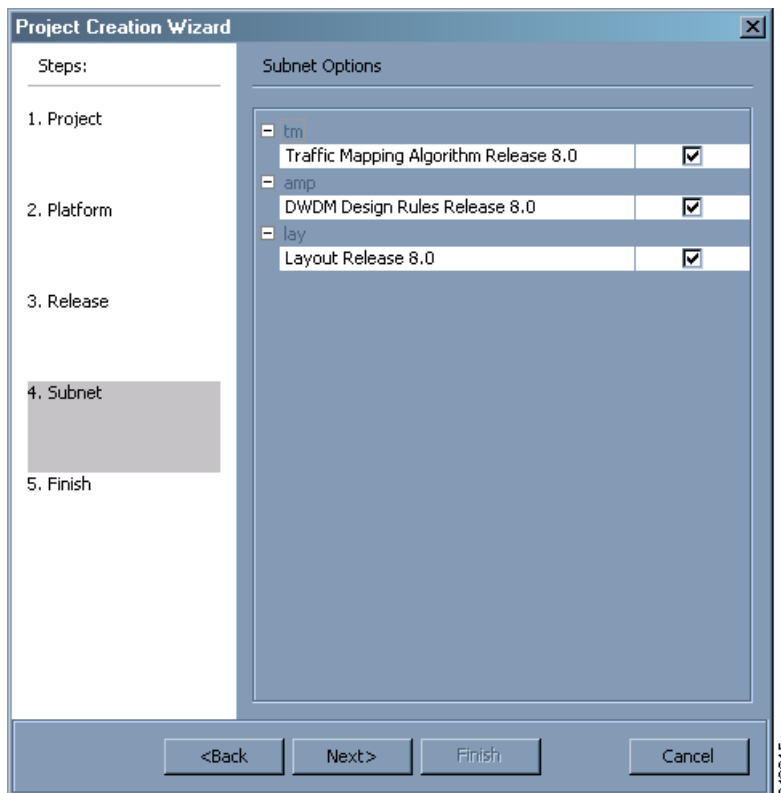

**Step 7** Click **Next**.

**Step 8** Complete one of the following:

- To run the Network Creation wizard, check the **Run the Network Wizard Now** check box and click **Finish**. Continue with [Step 9](#).
- To create an empty project to add sites and fibers manually, uncheck the **Run the Network Wizard Now** check box and click **Finish**. Project Creation wizard creates the project and an empty network and subnetwork under which you can manually add sites and fibers. Skip the remaining steps in this procedure. To add sites manually, see the “[2.3.1 Adding Sites](#)” section on page 2-45.

**Step 9** In the Topology page of the Network Creation wizard ([Figure 2-16](#)), choose **Ring** or **Linear** from the Network-Topology drop-down list.

**Step 10** To instruct Cisco TransportPlanner to automatically create a traffic subnet associated with the created network, check the Create Traffic Subnet check box. Cisco TransportPlanner creates (in addition to the Traffic\_ALL), an additional traffic subnet (Traffic\_Ring or Traffic\_Linear), depending on the topology value you specify in the Network Creation wizard.



Figure 2-16 Network Creation Wizard Topology Page

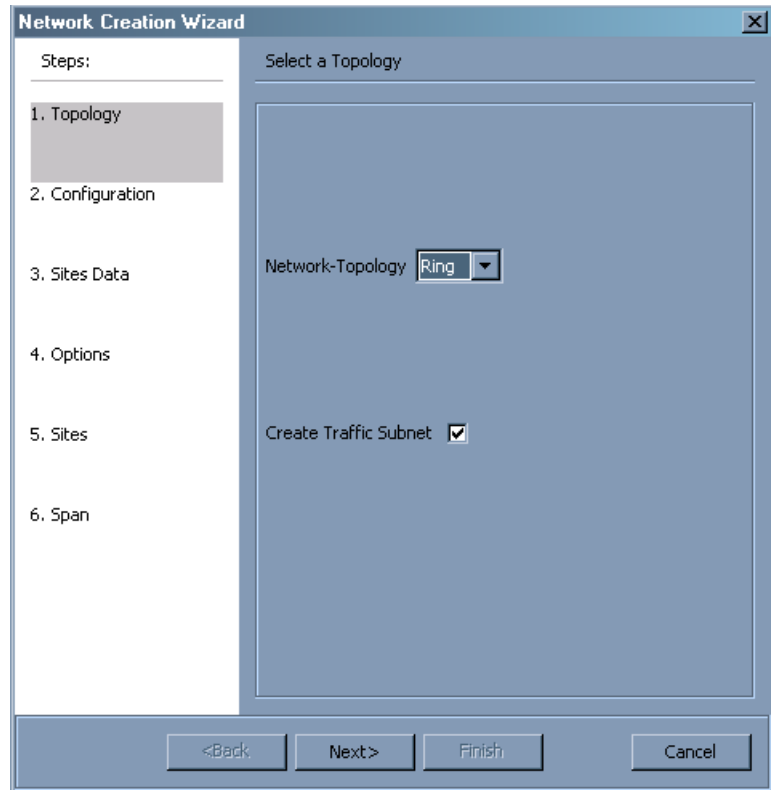

**Step 11** Click **Next**. On the **Configuration** page, enter the number of sites in the Site Number field and click **Next**. The maximum number of sites per network design is 100 sites and the default is 3. The maximum number of locations where the optical service channel (OSC) can be terminated in a network is 40. The maximum number of Add/Drop locations (equipped with WSS, WXC, multiplexer/demultiplexer, or OADM cards traversed by an optical circuit is limited to 40.

**Step 12** On the **Sites Data** page, select the topology for each site in the network [Figure 2-17](#). Allowed values are:

**Note**

The values allowed depend on the network topology selected in [Step 9](#). The default site value for Ring Topology is Line. The default site value for Linear topology is Line, except for the two end sites which will be Terminal. Terminal and Terminal+ are not allowed for ring network topology or for linear network topology intermediate sites.

- Terminal—Site with one side facing one fiber span.
- Terminal +—Site with one side facing one fiber span that can provide multi-degree expansion capability through an MMU unit.
- Line—Site with two sides facing two fiber span.
- Multi-degree—Nodes have more than two sides and face more than two fibre spans.
- Line + —Site with two sides facing two fiber spans that can provide multi-degree expansion capability through an MMU unit.

Figure 2-17 Network Creation Wizard- Site Data Page

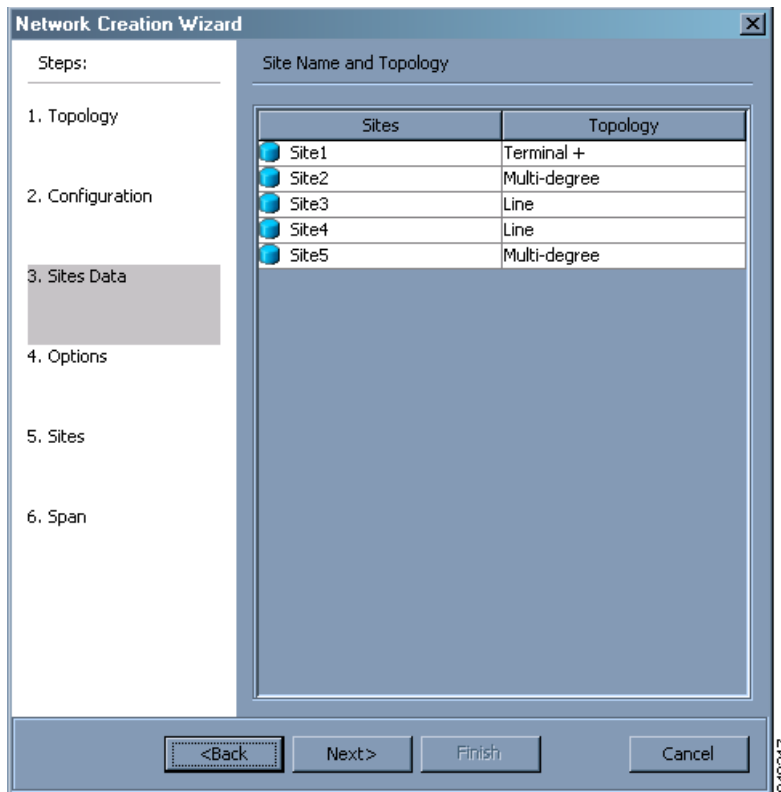

**Step 13** The Options page allows you to define C band and L band rules for the network design [Figure 2-18](#).

- C-band rules—The C-band options appear in the following format: 80Ch. 50Ghz +1dBm. The channels available are 80, 72, 64, 40, 32, 20, 16, or 8; the reference per channel power options available are -1 dBm, +1 dBm, 2 dBm, -2dBm, +4dBm, 5 dBm, 7dBm and 8 dBm; and the spacing options available are 100GHz or 50GHz.
- L-band Rules— The L-band options appear in the following format: 32 Ch. 100Ghz +5dBm. The options available are: None, Expand, and channels available are 32; the reference per channel power available are 2 dBm and 5 dBm; and, the spacing options available is 100GHz.

**Note**

If you use a Line+ or Multi-Degree site, you must select design rules based on 100 GHz channel spacing, and in the case of Line+, you must also select 32-channel rules. If these conditions are not met, Cisco TransportPlanner will provide an error message when you attempt to analyze the network. See [Table 2-24](#) for additional details on site design rules.

Figure 2-18 Network Creation Wizard Options Page

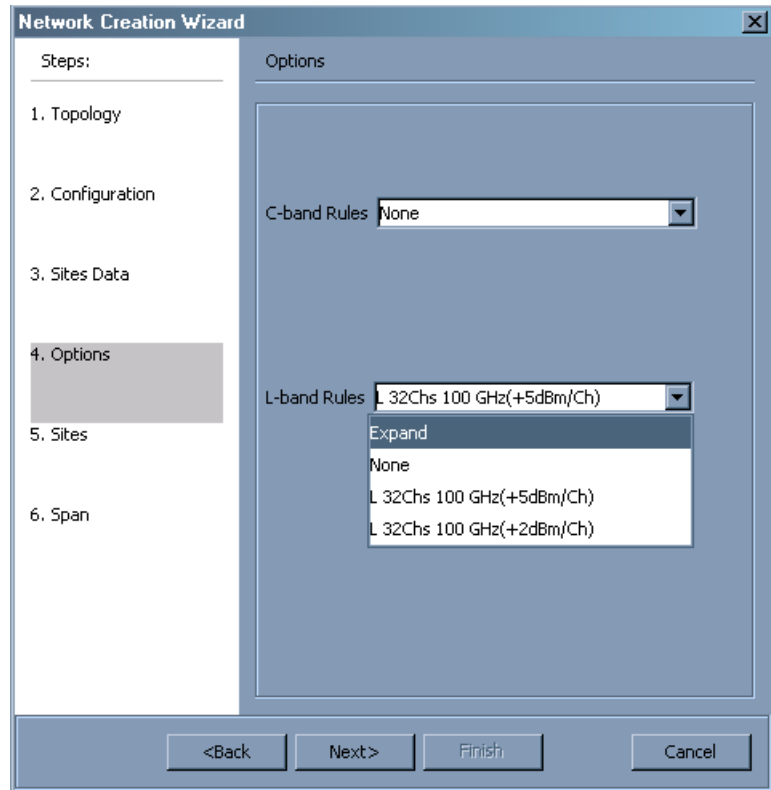

**Step 14** On the Site page, complete the following (Figure 2-19):

- Shelf Management—Choose the shelf management configuration:
  - Multi Shelf Integrated Switch—All the Multi Service Transport Platform (MSTP) optical cards (optical add/drop multiplexers [OADMs] and amplifiers) reside in different shelves connected by a LAN. The LAN is implemented with switches connected to the MSTP shelves. For this option, Multi-Shelf Integrated Switch Cards (MS-ISC) are used to support the multishelf configuration.
  - Multi Shelf External Switch—All the MSTP optical cards (OADMs and amplifiers) reside in different shelves connected by a LAN. The LAN is implemented with switches external to the MSTP shelves (Cisco Catalyst 2950). For this option, two external Ethernet switch units are used to support the multishelf configuration.
  - Individual Shelf—All the MSTP optical cards (OADMs and amplifiers) reside in the same shelf. For this option, multishelf management is not supported; every shelf is managed as an independent shelf.
- Node Protection—Choose **Same Shelf** (single shelf configurations) or **Separated Shelves** (multishelf configurations). Same Shelf configuration places all the OADM/ROADM units in a single shelf, and does not provide any protection at the shelf level in the node. Separated Shelves places OADM/ROADM units (west-facing and east-facing) in separate shelves in the node and it is selectable only if Multishelf management is selected. You can also set node protection for a multi-degree node.
- Hybrid Site Config—Check to create all the nodes configured as hybrid MSTP/Multi Service Provisioning Platform (MSPP) nodes. Hybrid Node is only available if you chose Individual Shelf as the Shelf Management type.

- OSMINE Compliant—Check this option to place the DWDM units in the shelves according to Operations Systems Modifications of Intelligent Network Elements (OSMINE) placement rules.
- DCC Chain—Check to put a TXP(P)\_MR\_2.5G card in Slot 12 on each shelf of each site to use DCC.
- Max Shelves per Rack—Choose the maximum number (from 1 to 4) of ANSI or ETSI shelves (equipping optical cards or TXP/MXP cards) that can be placed in each rack in the site when generating the layout of the site.
- Installation w/o M/P—Check this box to design a network that does not require the setup of configuration files (thresholds and setpoints). Installation without Cisco TransportPlanner is also known automatic node turn up. When this feature is enabled, the software in the node will configure itself with parameters; XML configuration files are not required to configure the node. When this option is selected at the end of EDFA and DCU placement, Cisco TransportPlanner will analyze the resulting network and verify that in each node, where the option “installation w/o Cisco TransportPlanner” is enabled, has:
  - A preamplifier in each direction.
  - All amplifiers working in gain control mode
  - A flat node output spectrum; that is, the resulting channel tilt at the exit of the node is 0
  - A feasible setpoint forced during simulation.

**Figure 2-19 Network Creation Wizard Sites Page**

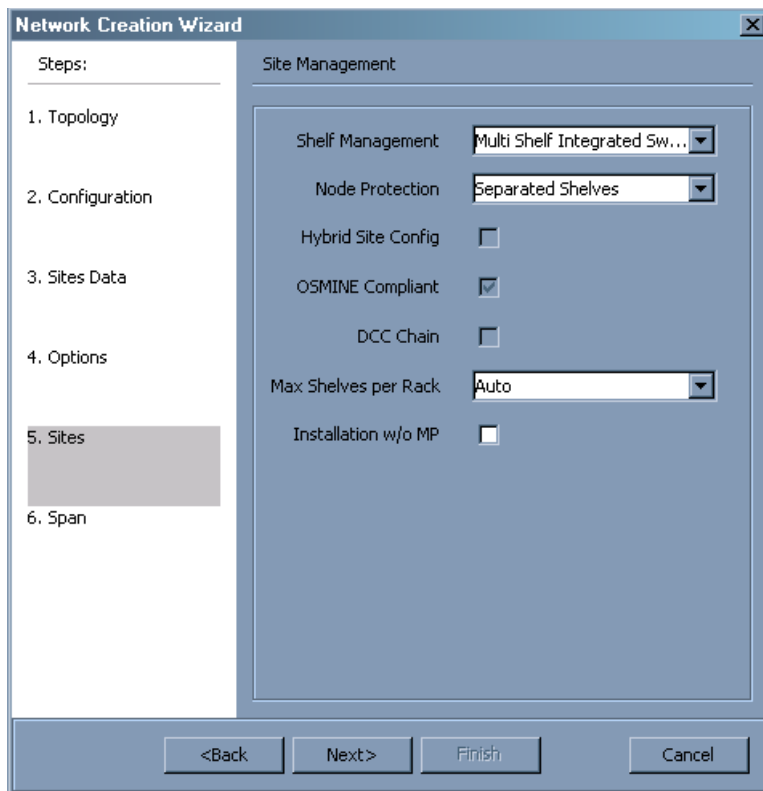

**Step 15** Click Next.

**Step 16** On the Span page, complete the following (Figure 2-20):

- Span Label Tag—Enter the desired span label.
- Span Fibre Type—Choose the fiber type for each span in the network.
- Span Length—Enter the span length. The displayed unit of measure is retrieved from the Span Measurements Units field.
- EOL Ageing Factor—Type the number to use when factoring fiber aging. This factor is multiplied by the SOL total span loss without connectors.
- EOL Ageing loss [dB]—Type the EOL aging loss value. The EOL loss-per-span value is added at the end of life to each discrete fiber in the network (for example, to add an EOL margin for splicing).



**Note**

Enter a value in either EOL Ageing Factor or EOL Ageing loss; you do not need to enter a value in both fields. Use one of the following formulas to calculate the fiber loss at SOL:

$$\text{SOL} = \text{km} * \text{dB/km} + (2 * \text{connector loss})$$

$$\text{SOL} = \text{user entered loss} + (2 * \text{connector loss})$$

Use one of the following formulas to calculate the fiber loss at EOL:

$$\text{EOL} = \text{km} * \text{dB/km} * \text{EOL Aging Factor} + (2 * \text{connector loss}) + \text{EOL Aging Loss}$$

$$\text{EOL} = \text{user entered loss} * \text{EOL Aging Factor} + (2 * \text{connector loss}) + \text{EOL Aging Loss}$$

- Connector loss [dB]—Type the concentrated loss at the end of the span.
- CD factor [ps/mn/km]—Type the fiber chromatic dispersion (CD) factor. The default value is dependent on the selected fiber type. Any value that you enter in this field is lost whenever you change the fiber type. Chromatic dispersion is always entered in ps/nm/km. Fiber chromatic dispersion is defined for the middle of the wavelength band. C-band is defined at 1545.3 nm; L-band is defined at 1590.4 nm.
- PMD factor [ps/sqrt(km)]—Type the polarization mode dispersion (PMD) factor. The default value is dependent on the selected fiber type. Any value that you enter in this field is lost whenever you change the fiber type. PMD is always entered per kilometers.
- Length Based Loss—If checked, the fiber loss is determined by Span Length \* Loss Factor. If the check box is not checked, you must enter the total loss of the span.
- Loss factor [dB/km]—Type the value of the SOL fiber loss per kilometer that is used to calculate the loss of each span in the network. The fiber loss factor is always entered in dB/km.
- Tot SOL loss w/o conn [dB]—Type the start of life link fiber loss for each span, without the connector concentrated loss. The total SOL loss without connectors is equal to the loss factor multiplied by the length. In the Length Based model, this value is calculated automatically.
- DCN extension—Click the check box to use DCN extensions on each of the spans in the network. This implies that the OSC channel is not used to connect the two nodes. All nodes facing a span with the DCN Extension option enabled require a ITU-T G.709 generic communications channel (GCC) access that must be provided by the customer.

Figure 2-20 Network Creation Wizard Span Page

The screenshot shows the 'Network Creation Wizard' dialog box, specifically the 'Span Parameters' tab. On the left, a 'Steps' list includes: 1. Topology, 2. Configuration, 3. Sites Data, 4. Options, 5. Sites, and 6. Span (which is highlighted). The main area contains the following parameters:

- Span Label Tag: Duct
- Span Fibre Type: Tera-Light
- Span Length [Km]: 1.0
- EOL Ageing Factor: 1.0
- EOL Ageing Loss [dB]: 0.0
- Connector Loss [dB]: 0.0
- CD Factor [ps/nm/km]: 7.76
- PMD Factor [ps/sqrt(km)]: 0.1
- Length Based Loss:
- Loss Factor [dB/km]: 0.25
- Tot SOL Loss w/o Conn [dB]: 1.0
- DCN Extension:

At the bottom, there are four buttons: <Back, Next>, Finish, and Cancel. A small vertical number '240357' is visible on the right side of the dialog box.

**Step 17** Click **Finish**. Cisco TransportPlanner checks the validity of the fiber factor values. If the fiber factor values are within the valid range (Table 2-5), Cisco TransportPlanner creates a visual representation of the network. If the values are out of range, Cisco TransportPlanner issues a warning, asking you to confirm the input values.

**Note**

All options set by the Network Creation Wizard can be changed as needed per site and per span.

Table 2-5 Valid Ranges for Fiber Factor Values

| Fiber Type      | Parameter                                         | Min. Error Value | Min. Warning Value | Default Value | Max. Warning Value | Max. Error Value | Unit     |
|-----------------|---------------------------------------------------|------------------|--------------------|---------------|--------------------|------------------|----------|
| ITU-T G.652-SMF | Loss factor                                       | 0                | 0.2                | —             | 0.4                | 10               | dB/km    |
|                 | Chromatic dispersion factor at 1545.3 nm (C-band) | 0                | 16.2               | 16.7          | 17.1               | 30               | ps/nm/km |
|                 | Chromatic dispersion factor at 1590.4 nm (L-band) | 0                | 18.53              | 19.03         | 19.43              | 30               | ps/nm/km |
|                 | PMD factor                                        | 0                | 0.0                | 0.1           | 0.5                | 10               | ps/(√km) |

**Table 2-5** Valid Ranges for Fiber Factor Values (continued)

| Fiber Type                                | Parameter                                         | Min. Error Value | Min. Warning Value | Default Value | Max. Warning Value | Max. Error Value | Unit     |
|-------------------------------------------|---------------------------------------------------|------------------|--------------------|---------------|--------------------|------------------|----------|
| ITU-T<br>G.655-E-LEAF                     | Loss factor                                       | 0                | 0.2                | —             | 0.4                | 10               | dB/km    |
|                                           | Chromatic dispersion factor at 1545.3 nm          | 0                | 3.4                | 3.80          | 4.2                | 10               | ps/nm/km |
|                                           | PMD factor                                        | 0                | 0                  | 0.1           | 0.5                | 10               | ps/(√km) |
| ITU-T<br>G.655-True Wave                  | Loss factor                                       | 0                | 0.2                | —             | 0.4                | 10               | dB/km    |
|                                           | Chromatic dispersion factor at 1545.3 nm          | 0                | 3.8                | 4.19          | 4.6                | 10               | ps/nm/km |
|                                           | PMD factor                                        | 0                | 0                  | 0.1           | 0.5                | 10               | ps/(√km) |
| ITU-T<br>G.652-DS<br>(Dispersion shifted) | Loss factor                                       | 0                | 0.2                | —             | 0.4                | 10               | dB/km    |
|                                           | Chromatic dispersion factor at 1590.4 nm (L-band) | 0                | 2.43               | 2.83          | 3.23               | 30               | ps/nm/km |
|                                           | PMD factor                                        | 0                | 0                  | 0.1           | 0.5                | 10               | ps/(√km) |

## 2.3.1 Adding Sites

Use the following procedure to add new sites to an existing network. A site is a customer premise location where any equipment can be co-located in a rack within a building. Cisco TransportPlanner supports up to 100 sites in a network. The number of racks and nodes in a site is independent of number of number of sites in the network. The maximum number of locations where the OSC can be terminated in a network is 40. When the number of locations where the OSC is terminated exceeds the maximum supported value, the tool completes the design, but in the summary report there will be an alarm to indicate this situation. The maximum number of add/drop locations in a network is 40. The maximum number of Add/Drop locations (equipped with WSS, WXC, multiplexer/demultiplexer, or OADM) traversed by an optical circuit is limited to 40.



### Note

Every new site added to a design is automatically configured as Multi-Shelf Integrated Switch with Same Shelf protection. To change this, you can edit the site properties after adding it to the network design. See the “[2.6.3 Editing Site Parameters](#)” section on page 2-92.

- 
- Step 1** Right-click the network folder in the Project Explorer and choose **Expand** from the shortcut menu.
- Step 2** Right-click the Sites folder and choose **New Site** from the shortcut menu. The Site Creation wizard appears ([Figure 2-21](#)). As an alternative, if sites already exist in the network design and you have the NtView *Name* tab open, click the **Create a new site** icon in the toolbar. For more information about the Cisco TransportPlanner icons, see [Appendix A, “GUI Information and Shortcuts.”](#)
- Step 3** Choose the interface type:
- Line—Two pairs of fibers are terminated at the node.

- Terminal—A single pair of fibers is terminated at the node.
- Line+—Two pairs of fibers are terminated at the node but the number of fibers can be increased. An MMU card (topology upgrade) must be installed.
- Terminal+—A single pair of fibers is terminated at the node but the number of fibers can be increased. An MMU card (topology upgrade) must be installed.
- Multi-degree—Nodes have more than two sides and face more than two fibre spans.

**Step 4** Click **Finish**.

**Figure 2-21 Site Creation Wizard**

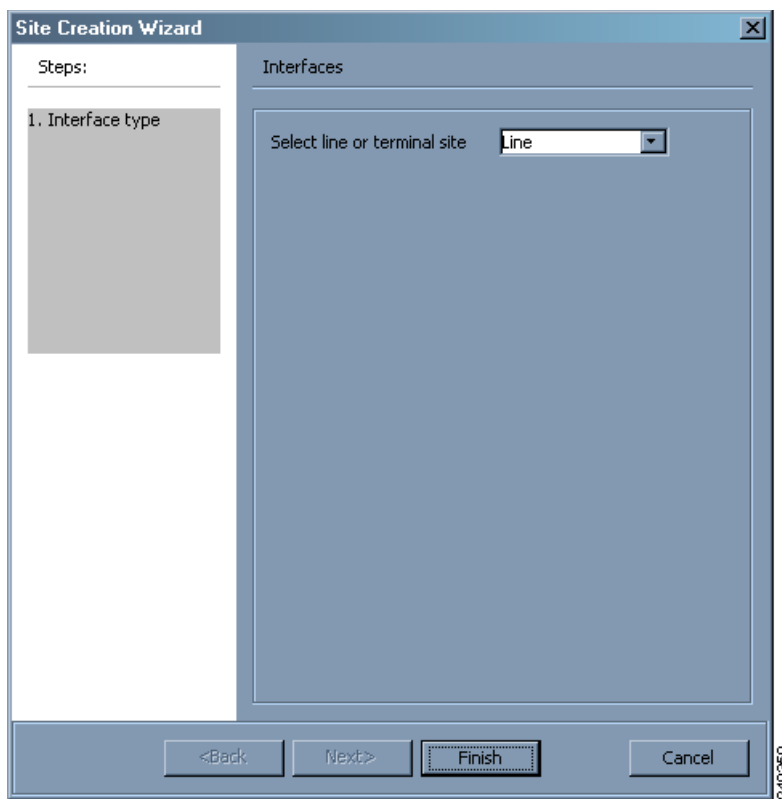

## 2.3.2 Adding Fiber Spans

Use the following procedure to manually add fiber spans between sites. A fiber span consists of a pair of fibers (one transmit and one receive) between two sites. A span is represented by a fiber duct in the *NetViewName* tab. Within a fiber duct, more than one fiber pair can exist.



**Note**

The number of fiber spans that each site can support is defined in the site properties. See the [“2.3.1 Adding Sites”](#) section on page 2-45 or the [“2.6.3 Editing Site Parameters”](#) section on page 2-92.

**Step 1**

In the *NetView Name* tab, click the Create a new duct icon in the toolbar. For more information about the Cisco TransportPlanner icons, see [Appendix A, “GUI Information and Shortcuts.”](#)



- Step 2** Click one of the sites that you want to connect with a fiber span. This site will be the source site for later network analysis output.
- Step 3** Click the destination site. A fiber span appears between the two sites. This site will be the destination site for later network analysis output.

For the first span, the source site is set as A and the destination site is set as B. Cisco TransportPlanner automatically adjusts East and West for additional spans.

## 2.3.3 Creating Traffic Subnet

- Step 1** In the Project Explorer tab, scroll down to Traffic Subnets. Right-click Traffic Subnets, and select **Create**.

The Traffic Subnet Creation wizard appears. See [Figure 2-22](#).

**Figure 2-22** Traffic Subnet Creation Wizard

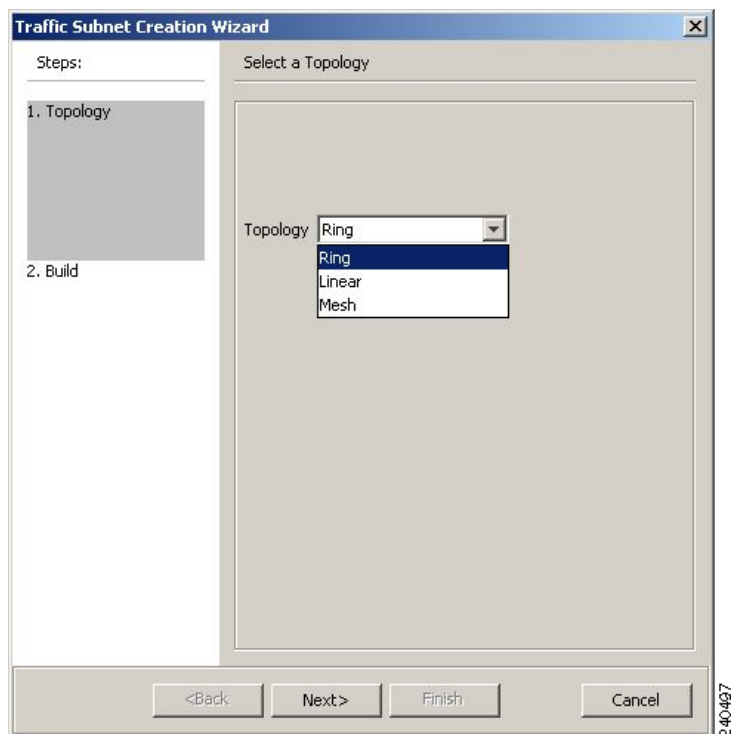

- Step 2** Select the Topology for the subnet from the drop-down list (**Ring**, **Linear**, and **Mesh**), then click **Next**.



**Note** If Ring or Linear topology is selected for the subnet, the spans in the subnet must be adjacent and also ordered.

- Step 3** Click Press to build new subnet. The Traffic Subnet Builder Wizard appears ([Figure 2-23](#)).
- Step 4** Select the ducts that should be a part of the subnet from the list displayed on the left handside, and click **OK**. This takes you back to the Traffic Subnet Creation Wizard.

- Step 5** Click **Finish** to complete the creation of the traffic subnet. The created subnet appears in Project Explorer under Traffic Subnets.

**Figure 2-23** Traffic Subnet Builder Wizard

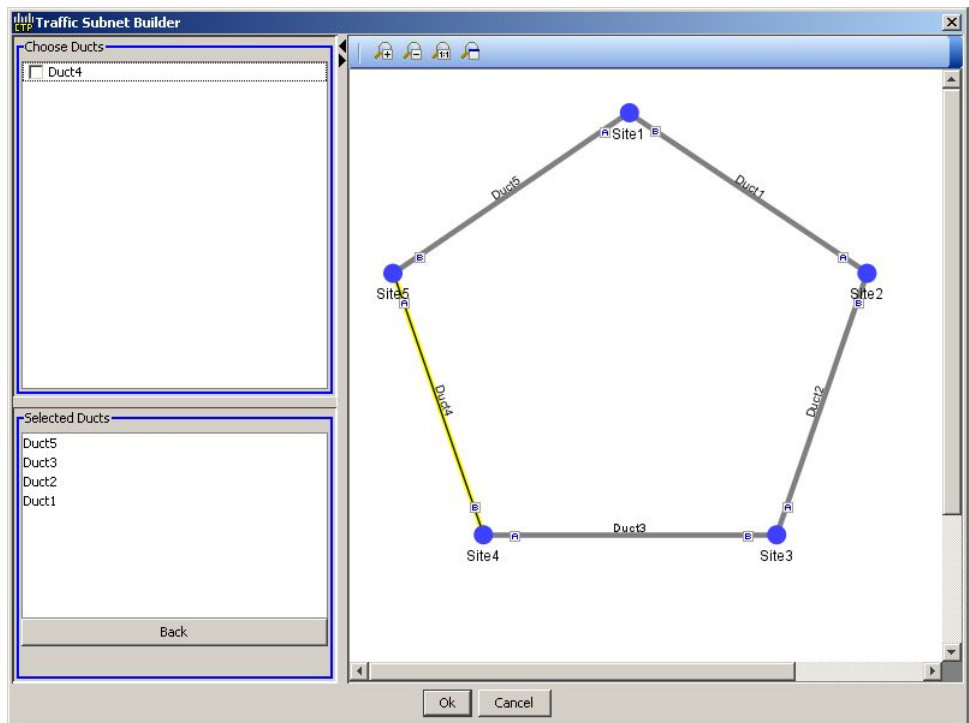

## 2.3.4 Creating a Point-to-Point Demand

Use the following procedure to add a point-to-point traffic demand:

- 
- Step 1** In the NtView *Name* tab, click the Create a new P2P demand icon in the toolbar. For more information about the Cisco TransportPlanner icons, see [Appendix A, “GUI Information and Shortcuts.”](#)
- Step 2** Click the source site of the demand.
- Step 3** Click the destination site of the demand. The Point to Point Demand Creation Wizard appears ([Figure 2-24](#)).
- Step 4** From the drop-down list, select **Traffic Subnet ALL** or any of the previously created traffic subnets to which this service demand should be part of, and proceed to [Step 5](#). If you wish to create a new traffic subnet see “[2.3.3 Creating Traffic Subnet](#)” section on page 2-47.
- Step 5** Click **Next**.

Figure 2-24 Point to Point Demand Creation Wizard

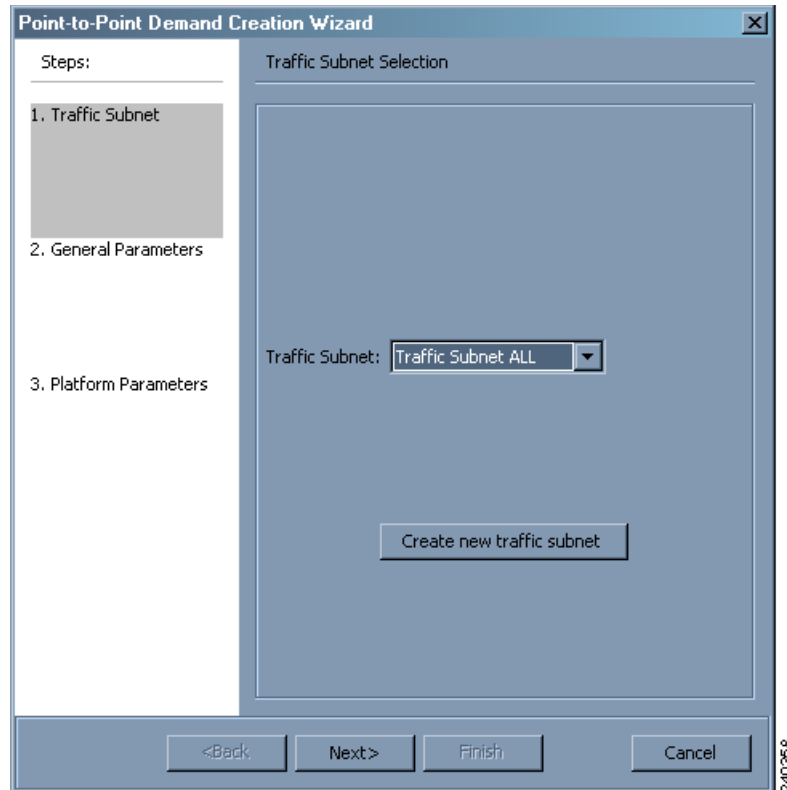

- Step 6** On the General Parameters page, complete the following:
- Label—Type the name of the demand.
  - Source—(Display only) Displays the source site name.
  - Destination—(Display only) Displays the destination site name.
  - Service Type—Choose the service type from the drop-down list. For a list of services, see the [“1.2.5 Service Support” section on page 1-4](#).
  - Present # ch—Enter the number of channels to be created. The Forecast # ch field automatically updates with the number entered in this field.
  - Forecast # ch—Enter the number of channels to be installed at a later date. This value includes the Present # ch value. For example, if you entered 4 in the Present # ch value and want to add two channels in the future, enter 6.
- Step 7** Click **Next**.
- Step 8** On the Platform Parameters page, complete the following:
- Protection—Choose the protection type from the drop-down list: **Y-Cable Protected**, **Client 1+1**, **Fiber Switched**, or **Unprotected**. For more information on protection types, see the [“1.2.4 Protection Scheme Support” section on page 1-4](#).
  - Path—(Unprotected only) Choose the routing type from the drop-down list:
    - **Auto**—Allows the highest degree of flexibility in routing the channels. Cisco TransportPlanner routes the channels with the lowest possible cost, given the other constraints.
    - **A**—Select this for a Terminal or a Terminal+ site.
    - **A or B**—Select either of these for a Line or a Line+ site.

- A, B, C, or D—Select either of these for a Multi-Degree site if four ducts are connected.
  - A, B, C, D, E, F, G, or H—Select either of these for a Multi-Degree site if eight ducts are connected.
- Optical Bypass—(Unprotected only) Choose the site where the channels for the current demand will be optically bypassed. A channel in optical bypass is dropped on one side of the node and added on the other side of the same node to allow the future use of that node as an add/drop location.
- Step 9** Complete the following fields in the Interface Parameters area. The options available are based on the service type selected in [Step 6](#).
- Transponder—Click to expand, then check the card type check box to select the card at the end sites of the service channels.
  - Line Card—Click to expand, then check the card type check box to select the card at the end sites of the service channels.
  - Alien Card—Appears only if you created a third-party interface as described in the [“2.2.4 Defining Third-Party DWDM Interfaces”](#) section on page 2-25. Click to expand, and then check the card type check box to select the card at the end sites of the service channels.
  - Pluggable Card—Click to expand, then check the card type check box to select the card at the end sites of the service channels.
- Step 10** In the Client Interface area, define the client interface type (SR, IR, or LR) for the source and destination from the Source and Destination drop-down lists. This option is available for transponder and muxponder interfaces that have pluggable client interfaces, and depends on the selected service type and card type.
- Step 11** Click **Finish**. The Edit Point to Point Demand dialog box appears listing the present and forecast channels.

The demand appears in the NtView *Name* tab and in the Project Explorer tree in the Service Demands > Point To Point folders. A demand is a solid line when selected and a dotted line when not selected. The line has a number above it that indicates the number of channels that are present.

[Figure 2-25](#) shows a selected point-to-point demand with five channels between Sites 1 and 2.

**Note**

To make changes to the demand parameters, see the [“2.6.6 Editing a Point-to-Point Demand”](#) section on page 2-100, or click **Cancel** to close the Edit Point to Point Demand dialog box.

**Figure 2-25 Point-to-Point Demand Between Two Sites**

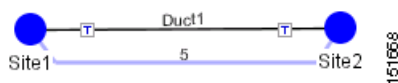
**Note**

For each network, Cisco TransportPlanner automatically creates a default subnet that exactly matches the overall network topology. This cannot be deleted.

## 2.3.5 Creating a Protected Ring Demand

Use the following procedure to create a P-ring traffic demand.

- Step 1** Create a ring network using either the procedures in the “2.3 Creating a Project” section on page 2-36 or by manually placing sites into a ring configuration.
- Step 2** In the Native Net# tab, click the Create a new P-Ring demand icon in the toolbar. The P-Ring Creation Wizard appears (Figure 2-26). For more information about the Cisco TransportPlanner icons, see Appendix A, “GUI Information and Shortcuts.”

**Figure 2-26 P-Ring Creation Wizard**

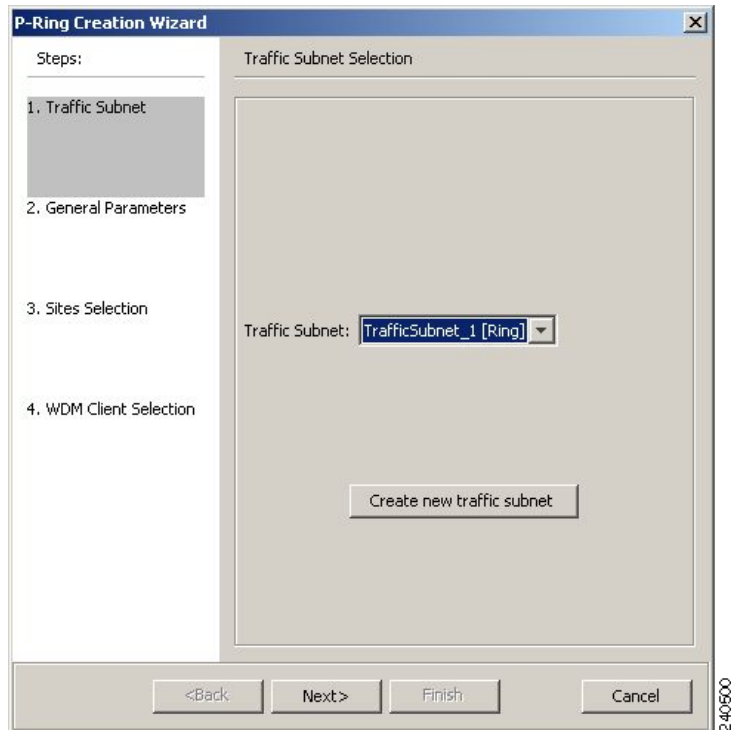

- Step 3** For each network, the tool automatically creates, a default subnet that exactly matches the overall network topology. This cannot be deleted. From the drop-down list, select any previously created traffic subnet with a ring topology that this circuit should be part of and proceed to Step 4. If you wish to create a new traffic subnet see 2.3.3 Creating Traffic Subnet, page 2-47.
- Step 4** On the General Parameters page, complete the following:
- Label—Enter the name of the demand.
  - Service Type—Choose the service type from the drop-down list. For a list of services, see the “1.2.5 Service Support” section on page 1-4.
  - Present # ch—Enter the number of channels to be created. The Forecast # ch field automatically updates with the number entered in this field.
  - Forecast # ch—Enter the number of channels to be installed at a later date. This value includes the Present # ch value. For example, if you entered 4 in the Present # ch value and want to add two channels in the future, enter 6.
- Step 5** Click **Next**.

**Step 6** On the Sites Selection page, in the Protection Sites area, press **Ctrl** and click the sites that you want to add to the P-ring. A P-ring requires at least two sites. Click the right arrow button. To remove a site added to the list, click the site and click the left arrow button.

In the Optical Bypass area, press **Ctrl** and click the sites that you want to add to the P-ring. Click the right arrow button. To remove a site added to the list, click the site and click the left arrow button.

**Step 7** Click **Next**.

**Step 8** On the WDM Client Selection page, complete the following interface parameters. The options available are based on the service type selected in [Step 4](#).

- **Transponder**—Click to expand, then check the card type check box to select the card at the end sites of the service channels.
- **Line Card**—Click to expand, then check the card type check box to select the card at the end sites of the service channels.
- **Alien Card**—Appears only if you created a third-party interface as described in the [“2.2.4 Defining Third-Party DWDM Interfaces”](#) section on page 2-25. Click to expand, and then check the card type check box to select the card at the end sites of the service channels.
- **Pluggable Card**—Click to expand, then check the card type check box to select the card at the end sites of the service channels.

In the Client Interface area, define the client interface type (SR, IR, or LR) for the source and destination from the Source and Destination drop-down lists. This option is available for transponder and muxponder interfaces that have pluggable client interfaces, and depends on the selected service type and card type.

**Step 9** Click **Finish**. The Edit P-Ring Demand dialog box appears.

The demand appears in the NtView *Name* tab and in the Project Explorer tree in the Service Demands > P-Rings folders. A demand is a solid line when selected and a dotted line when not selected. The line has a number above it that indicates the number of channels present. [Figure 2-27](#) shows a selected one-channel P-ring between Sites 1, 2, 3, and 5 with an optical bypass of Site 4.



**Note**

To make changes to the demand parameters, see the [“2.6.7 Editing a P-Ring Demand”](#) section on page 2-101, or click **Cancel** to close the Edit P-Ring Demand dialog box.

Figure 2-27 P-Ring Demand

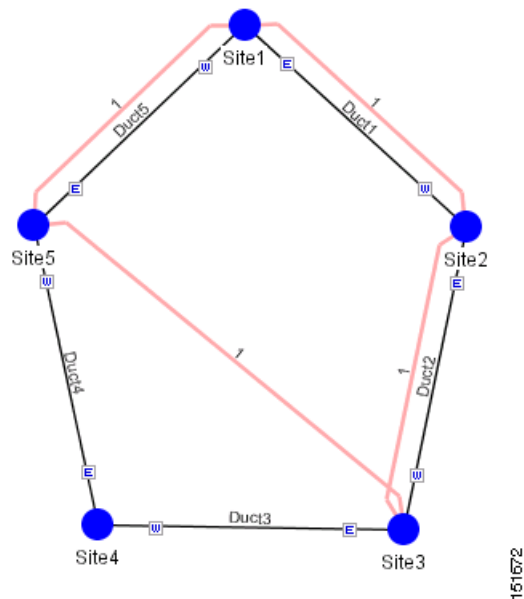

151672

## 2.3.6 Creating a ROADM Demand

Use the following procedure to create ROADM traffic groups and demands:

- Step 1** In the Project Explorer, under Nets, right-click the **ROADM** folder and choose **New ROADM Group**. The ROADM Group Creation Wizard appears.
- Step 2** Select the desired traffic subnet from the Traffic Subnet field. You can create a new traffic subnet if desired using the “[2.3.3 Creating Traffic Subnet](#)” section on page 2-47.
- Step 3** Type the ROADM traffic group name in the Group Name field.
- Step 4** Check the desired sites.
- Step 5** Click **Finish**. The new ROADM traffic group appears under the ROADM folder in the Project Explorer.
- Step 6** Right-click the new ROADM traffic group and choose **Create new ROADM demand** from the shortcut menu. The Create ROADM Demand dialog box appears ([Figure 2-28](#)).

Figure 2-28 Create ROADM Demand Dialog Box

| Service Types                                      | Yes/No                   | Client Interface     | Y-Cable                             | 1+1                                 | Fiber Switched                      | Supported |
|----------------------------------------------------|--------------------------|----------------------|-------------------------------------|-------------------------------------|-------------------------------------|-----------|
| <input type="checkbox"/> 10GE LAN PHY              | <input type="checkbox"/> | MXP_MR_2.5G          | <input checked="" type="checkbox"/> | <input checked="" type="checkbox"/> | <input type="checkbox"/>            |           |
| <input type="checkbox"/> 10GE WAN PHY              | <input type="checkbox"/> | MXP_MR_2.5G          | <input checked="" type="checkbox"/> | <input checked="" type="checkbox"/> | <input checked="" type="checkbox"/> |           |
| <input type="checkbox"/> 15530 10-Gbps Aggregated  | <input type="checkbox"/> | MXP_MR_100ME-w/FEC   | <input checked="" type="checkbox"/> | <input checked="" type="checkbox"/> | <input type="checkbox"/>            |           |
| <input type="checkbox"/> 15530 2.5-Gbps Aggregated | <input type="checkbox"/> | MXP_MR_100ME-w/FEC   | <input checked="" type="checkbox"/> | <input checked="" type="checkbox"/> | <input type="checkbox"/>            |           |
| <input type="checkbox"/> 15530 Data MXP            | <input type="checkbox"/> | MXP_MR_100ME-w/o FEC | <input checked="" type="checkbox"/> | <input checked="" type="checkbox"/> | <input type="checkbox"/>            |           |
| <input type="checkbox"/> 15530 MR Transport        | <input type="checkbox"/> | TXP_MR_10E-w/FEC     | <input checked="" type="checkbox"/> | <input checked="" type="checkbox"/> | <input type="checkbox"/>            |           |
| <input type="checkbox"/> 1G-FICON                  | <input type="checkbox"/> | TXP_MR_10E-w/FEC     | <input checked="" type="checkbox"/> | <input checked="" type="checkbox"/> | <input type="checkbox"/>            |           |
| <input type="checkbox"/> 2G-FICON                  | <input type="checkbox"/> | TXP_MR_10E-w/o FEC   | <input checked="" type="checkbox"/> | <input checked="" type="checkbox"/> | <input type="checkbox"/>            |           |
| <input type="checkbox"/> 2R Any Rate               | <input type="checkbox"/> | TXP_MR_10E-w/FEC     | <input checked="" type="checkbox"/> | <input checked="" type="checkbox"/> | <input type="checkbox"/>            |           |
| <input type="checkbox"/> D1 Video                  | <input type="checkbox"/> | TXP_MR_10E-y-w/FEC   | <input checked="" type="checkbox"/> | <input checked="" type="checkbox"/> | <input type="checkbox"/>            |           |
| <input type="checkbox"/> DW-6000                   | <input type="checkbox"/> | TXP_MR_10E-y-w/FEC   | <input checked="" type="checkbox"/> | <input checked="" type="checkbox"/> | <input type="checkbox"/>            |           |
| <input type="checkbox"/> DVB ASI                   | <input type="checkbox"/> | TXP_MR_10E-y-w/o FEC | <input checked="" type="checkbox"/> | <input checked="" type="checkbox"/> | <input type="checkbox"/>            |           |
| <input type="checkbox"/> ESCON                     | <input type="checkbox"/> | TXP_MR_10E-y-w/FEC   | <input checked="" type="checkbox"/> | <input checked="" type="checkbox"/> | <input type="checkbox"/>            |           |
| <input type="checkbox"/> Fast Ethernet 100Mbps     | <input type="checkbox"/> | MXP_2.5G_10E-w/FEC   | <input checked="" type="checkbox"/> | <input checked="" type="checkbox"/> | <input type="checkbox"/>            |           |
| <input type="checkbox"/> Fibre Channel             | <input type="checkbox"/> |                      |                                     |                                     |                                     |           |

- Step 7** Enter a name for the demand in the Demand Name field.
- Step 8** Select a traffic pattern type (Hub or Meshed) from the Traffic Type drop-down list. If you select Hub, the First Site drop-down list becomes available. If you selected Meshed, proceed to [Step 10](#).
- Step 9** For Hub traffic types, select the originating site from the First Site drop-down list.
- Step 10** Select a connectivity type from the Connectivity type drop-down list: **Protected**, **Unprotected Minimum Hop**, **Unprotected Optimum Path**, or **Unprotected Subnet**. Refer to the “[1.5.3 ROADM Traffic Demands](#)” section on page 1-9 for more information on the connectivity choices. If you chose Unprotected Subnet, continue with the next step; otherwise proceed to [Step 12](#).
- Step 11** If you chose Unprotected Subnet, choose the starting site and the direction the ring must be traversed from the drop-down lists.
- Step 12** In the Service Types list, check the boxes for one or more client service types for the ROADM demand. The client interfaces that support each service type appear in the table to the right of the Service Types list.
- Step 13** To further define the client interfaces, complete the following options for each client interface listed in the table. Check boxes in gray are not available for selection.
- Yes/No—Check to select this card to implement the service type.
  - Client Interface—(Display only) Displays the card type for the selected service type.
  - Y Protected—Check to select Y-cable protection if the connectivity type is Protected.
  - 1+1 Protected—Check to select 1+1 protection if the connectivity type is Protected.
  - Fiber Switched—Check to select fiber-switching protection if the connectivity type is Protected.
  - Supported Service—(Display only) Displays the service types supported for the card.
- You can select more than one client interface to support the same service type. By default, Cisco TransportPlanner checks the best client interface to support each service.
- Step 14** Click **Ok** to create the demand.



## 2.3.7 Creating Ethernet Aggregated Demand

An Ethernet aggregated demand is a collection of low rate Gigabit Ethernet/10Gigabit Ethernet services that can be aggregated on a single 10-Gbps Wavelength Division Multiplexing (WDM) trunk. It is supported only by the GE\_XP and 10GE\_XP cards when configured as an L2-Switch. The Ethernet Aggregation Creation wizard allows you to create one WDM transport channel at a time over a predefined traffic subnet, specify the wavelength to be used for the channel, and define a list of locations with add/drop VLAN circuit capability. You can also create a set of desired VLAN circuits on this WDM transport channel. The check functionality generates a report showing for each section of the subnet where the WDM transport channel is over allocated and then perform when the corrective action is required. The clone functionality creates an identical copy of the current WDM transport channel with the same add/drop sites and WDM channel configuration parameters. You can then start filling this channel with the desired circuits.

Use the following procedure to create Ethernet aggregated demands:

- Step 1** In the NtView *Name* tab, click the Create new Ethernet Aggregated demand icon in the toolbar. For more information about the Cisco TransportPlanner icons, see [Appendix A, “GUI Information and Shortcuts.”](#) The EthernetAggr Creation Wizard appears ([Figure 2-29](#)).

**Figure 2-29 Ethernet Aggregation Creation Wizard**

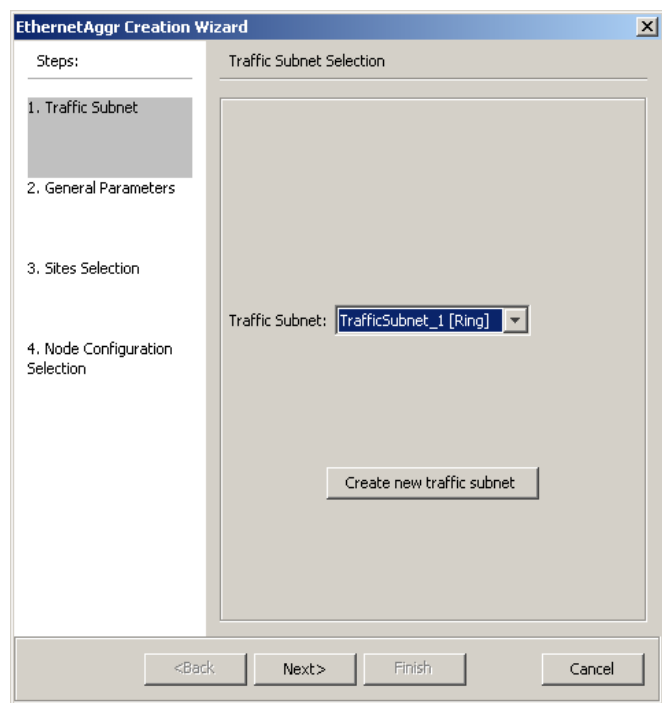

- Step 2** Select the desired traffic subnet from the Traffic Subnet drop-down list. You can create a new traffic subnet if desired using [2.3.3 Creating Traffic Subnet, page 2-47](#).
- Step 3** Click **Next**.
- Step 4** In the General Parameters page, complete the following:
- **Label**—Type the name of the demand. The default value is EthernetAggr1.

- **Present/Forecast**—Check this box if this demand will be needed in the future; uncheck this box if this demand is needed now. This parameter will drive the list of pluggable port modules to be equipped on the card and will affect BoM reports.

**Step 5** Click **Next**.

**Step 6** On the site selection page, complete the following:

- In the Protection Sites area, press **Ctrl** and click the sites that you want to add to the ethernet aggregated demand. An Ethernet aggregated demand requires at least two sites. Click the right arrow button. To remove a site added to the list, click the site and click the left arrow button.
- In the Optical Bypass area, press **Ctrl** and click the sites that you want to add to Ethernet aggregated demand. Click the right arrow button. To remove a site added to the list, click the site and click the left arrow button. If the Present/Forecast check box is checked, then you cannot select Optical Bypass sites. A channel in optical bypass is dropped on one side of the node and added on the other side of the same node to allow the future use of that node as an add/drop location.

**Step 7** On Node Configuration Selection page, complete the following:

- **DWDM Trunk**—Select the DWDM trunk type. You can specify the kind of WDM trunk interface for the card in each add/drop site allowed. Allowed values are: **Auto**, **w/EFEC**, **w/FEC**, and **w/o FEC**.
- **Wavelength**—This allows the user to force the current WDM transport channel wavelength. Allowed values are:
  - **Auto**—This allows the tool to assign wavelength to the channel with the lowest possible cost, given the other set of constraints.
  - **Allowed wavelength bands**—**C band-32 ch.odd**, **L band- 32 ch.odd**, **C band- 40 ch**, or **C band- 80 ch**. Wavelengths are listed based on the selected band. Choose a desired wavelength for the WDM transport channel.
- In the **New CFG** field, select the desired card type for each site.

**Step 8** Click **Finish** to complete the creation of WDM transport channel. This brings up a window that allows to add circuits to this WDM transport channel (see [Figure 2-30](#)).

**Step 9** Click **Close**. To add circuits to this channel, see the “[2.6.9 Editing an Ethernet Aggregated Demand](#)” section on page 2-103.

**Step 10** If you wish to clone this demand, click the **Clone** button on the left corner of the screen. A new demand, which is a copy of this demand, will be created and will appear in the Project Explorer pane.

Figure 2-30 EthernetAggr2 Demand Window, DWDM Channel Tab

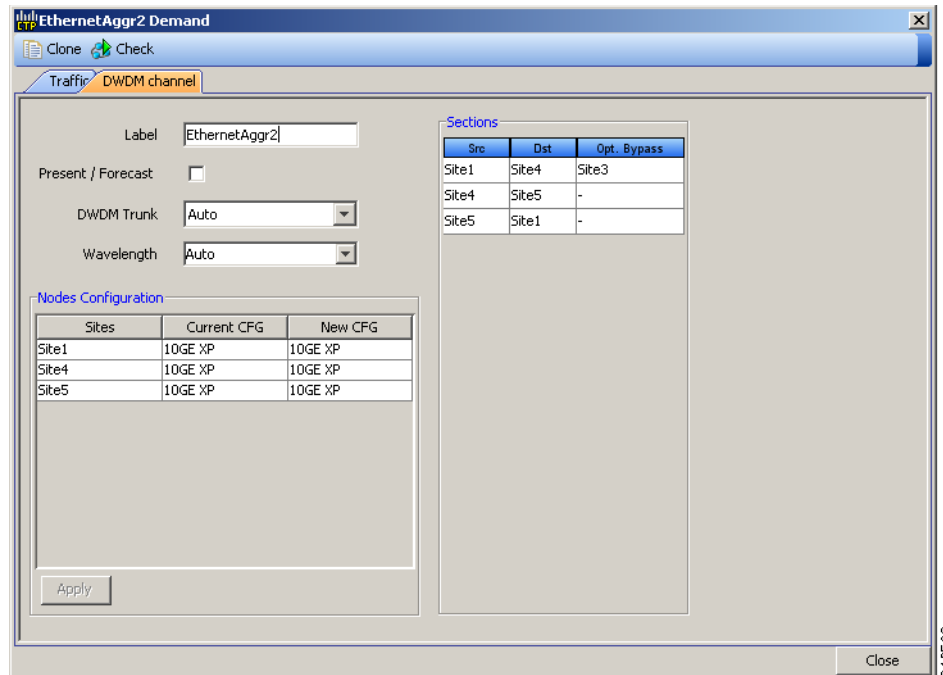

## 2.3.8 Creating TDM Aggregated Demand

A TDM aggregated demand is a collection of low rate SONET and Gigabit Ethernet services that is aggregated on a single 10G WDM trunk. TDM aggregated demand is a specific service demand that is carried only by the ADM-10G card. It is possible to define Aggregated TDM Demand only for ANSI design and this demand is supported only on a ring traffic subnet.

The TDM Aggr Creation wizard allows you to create one WDM transport channel at a time over a predefined traffic subnet, specify the wavelength to be used for the channel, and define a list of locations with add/drop STS circuit capability. You should create a set of STS circuits on this WDM transport channel to pass traffic. The check functionality will generate a report showing, for each section of the subnet, where the WDM transport channel is over allocated and then perform, when required, the corrective action.

The total amount of bandwidth used by all the defined circuits in each section of the WDM transport channel cannot exceed the maximum channel capacity of STS-192c. Sections exceeding the maximum capacity are colored red in the report. Demands that fail the check will be flagged as invalid demands and the Analyzer will stop.

The clone functionality allows you to create an empty copy of the current WDM transport channel, with same add/drop sites and WDM channel configuration parameters. You can then start filling this channel with the desired circuits.

Use the following procedure to create TDM aggregated demands:

- Step 1** In the NtView *Name* tab, click the Create new TDM Aggregated demand icon in the toolbar. For more information about the Cisco TransportPlanner icons, see [Appendix A, “GUI Information and Shortcuts.”](#) The TDMAggr wizard appears ([Figure 2-31](#)).

**Figure 2-31** TDM Aggr Creation Wizard

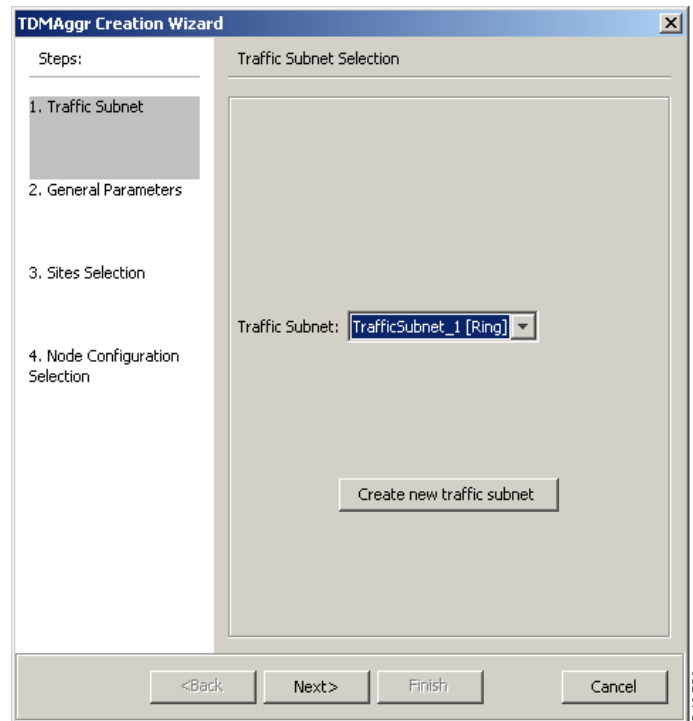

- Step 2** Select the desired traffic subnet from the Traffic Subnet drop-down list. You can create a new traffic subnet if desired using [2.3.3 Creating Traffic Subnet, page 2-47](#).
- Step 3** Click **Next**.
- Step 4** In the General Parameters page, complete the following:
- **Label**—Type the name of the demand. The default value is TDMAggr1.
  - **Present/Forecast**—Check this box if this demand will be needed in the future; uncheck this box if this demand is needed now. This parameter will drive the list of pluggable port modules to be equipped on the card and will affect BoM reports.
- Step 5** Click **Next**.
- Step 6** In site selection area complete the following
- In the Protection Sites area, press **Ctrl** and click the sites that you want to add to the ethernet aggregated demand. An Ethernet aggregated demand requires at least two sites. Click the right arrow button. To remove a site added to the list, click the site and click the left arrow button.

- In the Optical Bypass area, press **Ctrl** and click the sites that you want to add to Ethernet aggregated demand. Click the right arrow button. To remove a site added to the list, click the site and click the left arrow button. If the Present/Forecast check box is checked, then you cannot select Optical Bypass sites. A channel in optical bypass is dropped on one side of the node and added on the other side of the same node to allow the future use of that node as an add/drop location.

**Step 7** In Node Configuration selection, complete the following:

- DWDM Trunk—Select the DWDM trunk type to specify the kind of WDM trunk interface for the card in each allowed add/drop site. Allowed values are: **Auto**, **w/EFEC**, **w/FEC**, and **w/o FEC**.
- Wavelength—Allows you to force the current WDM transport channel wavelength. Allowed values are:
  - Auto—Allows Cisco TransportPlanner to assign wavelength to the channel with the lowest possible cost, given the other set of constraints.
  - Allowed wavelength bands—**C band-32 ch.odd**, **L band- 32 ch.odd**, **C band- 40 ch**, or **C band- 80 ch**. Wavelengths are listed based on the selected band. Choose a desired wavelength for the WDM transport channel.

**Step 8** Click **Finish** to complete the creation of WDM transport channel. The WDM Transport Channel Management Wizard appears (see [Figure 2-32](#)) that allows you add circuits to this WDM transport channel.

**Step 9** Click **Close**. To add circuits to this channel, see “[2.6.10 Editing a TDM Aggregated Demand](#)” section on page 2-108.

**Step 10** If you wish to clone this demand, click the **Clone** button on the left corner of the screen. A new demand, which is a copy of this demand, will be created and will appear in the Project Explorer pane.

**Figure 2-32** TDMAggr Demand

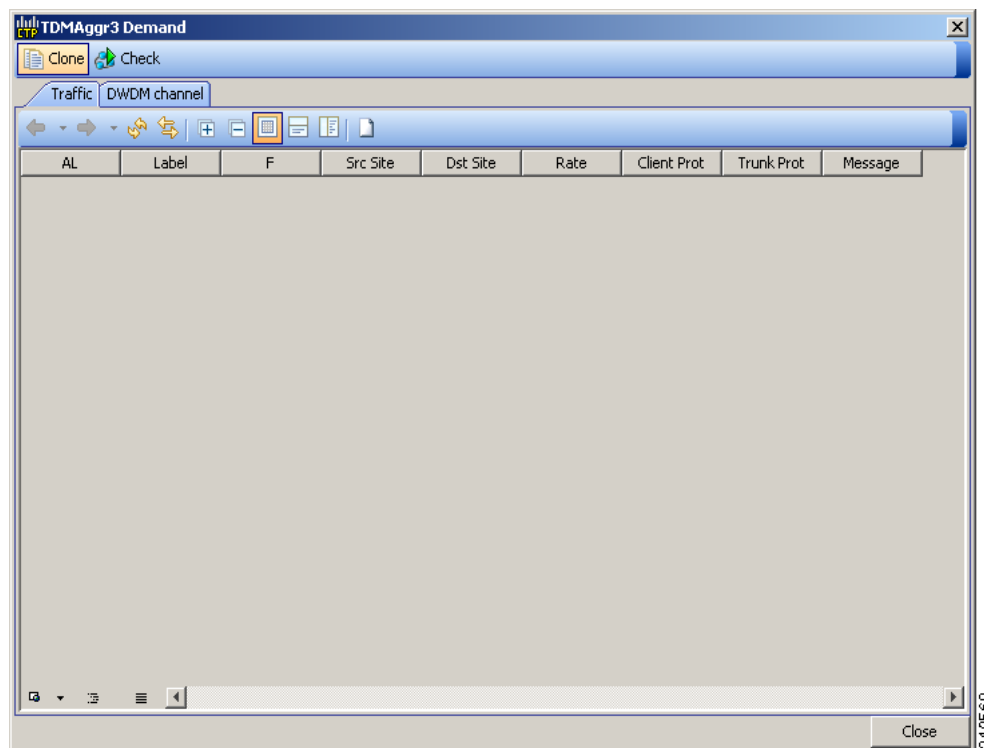

## 2.3.9 Adding Notes to a Project

Use the following procedure to add a note to any item in the Project Explorer. Each network has a Notes folder in the Project Explorer. After you have created a note, it appears in the Notes folder for that particular network.

- 
- Step 1** Right-click the desired item in the Project Explorer and choose **Edit Note** from the shortcut menu.
  - Step 2** In the Edit Note creation box, enter the desired text.
  - Step 3** To close the Edit Note creation box and to save the note, click the **X** in the upper right corner of the window.
  - Step 4** To view notes, double-click the **Notes** folder. The Notes window appears. [Table 2-6](#) lists the columns in the Notes window.

**Table 2-6** Notes Window

| Column | Description                                                                                                     |
|--------|-----------------------------------------------------------------------------------------------------------------|
| Header | Displays the note text. To view the entire note, click the plus (+) sign next to the header to expand the text. |
| Action | Click <b>Go</b> to open the item in the Project Explorer where the note was created.                            |
| Source | Displays the location of the note, for example, ProjectManager.Nets.Net2.Sites.Site2.W.                         |

- Step 5** To close the Notes window, click the **X** in the upper right corner of the window.
- 

## 2.3.10 Creating an Optical Subnet

An optical subnet is a collection of spans with certain associated, defined, common properties. You can define distinct optical subnets on the same network and can also set a list of associated properties on each of them.

The following properties are supported in an optical subnet:

- C-band Rules—Allows you to define rules for the C-band channels, the maximum per channel power, and the channel spacing for the design.
- L-band Rules—Allows you to define, for the L-band channels, the maximum per channel power, and the channel spacing for the design.

When you create a new project (see the [“2.3 Creating a Project” section on page 2-36](#)), Cisco TransportPlanner automatically creates an optical subnet associated to the network. At least one optical subnet (even if empty) must exist for each network in a project.

You can create an optical subnet using the Project Options (default) Optical Subnet property (Design Rules) values. To do this:

- 
- Step 1** Select the **Optical Subnet** folder in Project Explorer. The Optical Subnet Pane appears in the Task Pane on the right side of the screen ([Figure 2-33](#)).

Figure 2-33 Creating Optical Subnet

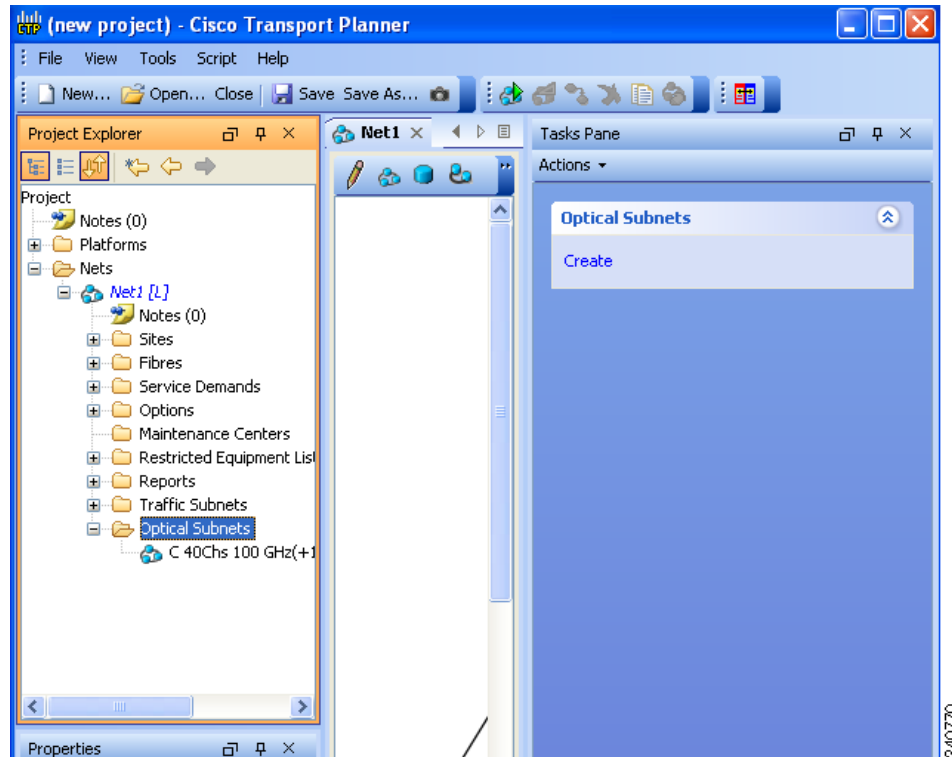

- Step 2** Click **Create**. The **Create Optical Subnet** dialog box appears (Figure 2-34). The default name, which is a combination of the user-created C-band and L-band rules, and the wizard-created default C-band and L-band rules are displayed.

Figure 2-34 Create Optical Subnet Dialog Box

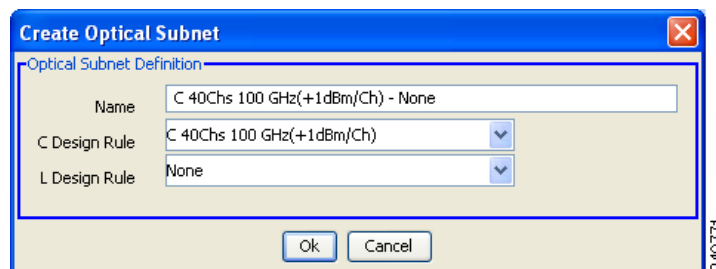

- Step 3** Select C-band and L-band design rules from the C Design Rule and L Design Rule drop-down lists for the new optical subnet that you want to create.
- Step 4** Click **OK**. A new optical subnet with the design properties you selected is created and placed in project explorer under the Optical Subnets folder.



**Note** You cannot create more than one optical subnet with the same properties values and each span must be part of only one optical subnet.

Cisco TransportPlanner allows you to modify, edit, define an optical subnet as current, and to delete an optical network. To do these, select the optical subnet you want to change in Project Explorer and choose the appropriate Modify, Edit, Set as Current, or Delete options under **Optical Subnets** in the Tasks Pane.

**Note**

When you delete an optical subnet, all the spans contained in the deleted optical subnet are placed within the current optical subnet. In case the current optical subnet is deleted, all their spans will be automatically placed within the optical subnet with the greatest number of spans. When the current optical subnet is removed, the tool automatically defines as current the optical subnet with the greatest number of contained spans.

## 2.4 Analyzing the Network

After you have created the desired sites, fiber spans, and service demands, you must analyze the network to determine network performance. The network must be in the Design, Install, or Upgrade state before you can analyze it. Cisco TransportPlanner automatically optimizes the design and summarizes the optical transmission performance. If there are problems with the design, Cisco TransportPlanner lists the problems and descriptions in the Analyzer Messages pane.

Use the following procedure to analyze the network:

- 
- Step 1** Click the **Networks Mgmt Tree** tab, and click the network that you want to analyze.
  - Step 2** Click the Analyze Network icon in the toolbar. For more information about the Cisco TransportPlanner icons, see [Appendix A, “GUI Information and Shortcuts.”](#) As an alternative, click **Analyze** in the Tasks Pane.  
The Cisco TransportPlanner analysis status bar indicates when the network analysis is complete.
  - Step 3** If any problems occur during the analysis, click the **Analyzer** tab to view the results on the Analyzer Messages pane. The Summary report appears. See the [“2.5.1 Viewing the Summary Report”](#) section on [page 2-63](#) for more information. Warning and error messages help you identify problems with your current design. For a list of all system messages, see [Appendix C, “System Messages.”](#)
  - Step 4** If necessary, resolve the problems listed in the Summary report. After you resolve the problems in the network, you can analyze the network again.

**Note**

You can return a Design-Analyzed network to the design state to make further changes by clicking the network icon in the Networks Mgmt Tree and clicking **Design** in the Tasks Pane.

## 2.5 Viewing Network Reports

Cisco TransportPlanner provides the reports listed in [Table 2-7](#). Report availability depends on whether a network has been analyzed or whether it is in the Install or Upgrade state. Reports are also available by site. See [Table 2-7](#) for report availability details.

**Note**

Although the following procedures use the Tasks Pane to access reports, you can also access reports by clicking the desired report in the Project Explorer tree Reports folder.



**Table 2-7 Report Availability**

| Report                  | Network Availability           | Site Availability              |
|-------------------------|--------------------------------|--------------------------------|
| NE Update               | Analyzed                       | —                              |
| Installation Parameters | Analyzed                       | Analyzed                       |
| Traffic Matrix          | Analyzed                       | Analyzed                       |
| Layout                  | Install, Upgrade, and Analyzed | Install, Upgrade, and Analyzed |
| Link Availability       | Analyzed                       | Analyzed                       |
| Internal Connections    | Analyzed                       | —                              |
| Optical Results         | Analyzed                       | Analyzed                       |
| Wavelength Routing      | Analyzed                       | —                              |
| Summary                 | Install, Upgrade, and Analyzed | Install, Upgrade, and Analyzed |
| Bill of Material        | Install, Upgrade, and Analyzed | Install, Upgrade, and Analyzed |

For more information on the Bill of Materials report, see the [“2.8 Generating a BoM”](#) section on page 2-131. In addition, you can compare the following reports using the Reports Diff tool: Bill of Material, Internal Connections, and Installation Parameters.

To complete the procedures in this section, you must have a project open and the network(s) loaded. See the [“2.1.1 Opening a Project”](#) section on page 2-15 and the [“2.1.2 Loading and Unloading Networks”](#) section on page 2-15.

## 2.5.1 Viewing the Summary Report

The Summary report summarizes design information, optical results, design cost, and analyzer messages. You can view it before or after you analyze a network. It automatically appears when you analyze a network. Use the following procedure to view the report at another time:

- 
- Step 1** Complete one of the following:
- To view the Summary report for a network, click the **Networks Mgmt Tree** tab and click the network.
  - To view the Summary report for a site, click the **NtView Name** tab and click the site.
- Step 2** In the Tasks Pane, click **Summary**. The Summary tab appears ([Figure 2-35](#)).

Figure 2-35 Summary Tab

The screenshot displays the Summary Tab interface, which is organized into several sections:

- Design info:** A table with the following data:
 

|               |             |
|---------------|-------------|
| Version       | 7.0.0.13    |
| Customer name | -           |
| Created by    | kimmcc      |
| Release       | release 7.0 |
- Optical results:** A table showing counts for various optical components:
 

|              | Demands | Green | Yellow | Orange | Red |
|--------------|---------|-------|--------|--------|-----|
| PointToPoint | 0       | -     | -      | -      | -   |
| P-Rings      | 1       | -     | -      | -      | -   |
| ROADMs       | 0       | -     | -      | -      | -   |
| Totals       | 1       | 0     | 0      | 0      | 0   |

Detailed optical results data are available through [Optical Results Report](#)
- Design cost info:** A table with the following data:
 

|                              |               |
|------------------------------|---------------|
| Price list                   | MasterPriceDB |
| Currency                     | Usd           |
| BoM total discounted         | 2,338,605.00  |
| Spare total discounted       | 0.00          |
| BoM + Spare total discounted | 2,338,605.00  |

For a detailed report, see [Network Bill Of Material](#)
- Messages:** A section containing a legend and a list of messages:
 

| Legend |                |      |                  |
|--------|----------------|------|------------------|
| Icon   | Message Type   | Icon | Message Type     |
| i      | Info messages  | ⚠    | Warning messages |
| ✖      | Error messages | ⛔    | Fatal errors     |

|   | Header                                       | Action | Source |
|---|----------------------------------------------|--------|--------|
| i | No specific anti-ASE node is required for... |        |        |
| i | Analysis ended successfully                  |        |        |

At the bottom of the interface, there is a tab labeled **Summary**.

Table 2-8 lists the categories in the Summary tab and their descriptions.

**Table 2-8 Summary Tab Categories**

| Category         | Description                                                                                                                                                                                                                                                                                                                                                                                                                                                                                                                                                                                                                  |
|------------------|------------------------------------------------------------------------------------------------------------------------------------------------------------------------------------------------------------------------------------------------------------------------------------------------------------------------------------------------------------------------------------------------------------------------------------------------------------------------------------------------------------------------------------------------------------------------------------------------------------------------------|
| Design info      | Displays the following information: <ul style="list-style-type: none"> <li>• Version—Displays the Cisco TransportPlanner software release version.</li> <li>• Customer name—Displays the name of the customer requiring this network design.</li> <li>• Created By—Displays the user login name.</li> <li>• Release—Displays the Cisco TransportPlanner software release number.</li> </ul>                                                                                                                                                                                                                                  |
| Optical results  | Indicates how many demands are included in the network, and identifies the number and severity of alarms for each demand.                                                                                                                                                                                                                                                                                                                                                                                                                                                                                                    |
| Design cost info | Displays the following information: <ul style="list-style-type: none"> <li>• Price list—Displays the price list used.</li> <li>• Currency—Displays the currency selected for the price list.</li> <li>• BoM total discounted—Displays the total price of the products (excluding spare parts) in the network with the discount applied.</li> <li>• Spare total discounted—Displays the total price of the spare parts in the network with the discount applied</li> <li>• BoM + Spare total discounted—Displays the total price of the products (including spare parts) in the network with the discount applied.</li> </ul> |
| Messages         | Displays any analyzer messages that occurred as a result of network analysis. Warning and error messages will help you identify problems with your current design. For a list of all system messages, see <a href="#">Appendix C, “System Messages.”</a>                                                                                                                                                                                                                                                                                                                                                                     |

## 2.5.2 Saving the NE Update File

After Cisco TransportPlanner completes network analysis, you can create a configuration file. If the Optical Networking System (ONS) is Software Release 7.0 or later, a single XML file is created including all of the parameters for all the sites in the network; if the ONS is Software R4.7 or R5.0, a single TXT file is created for each site in the network. This file can be directly imported to a site using the NE Update feature in Cisco Transport Controller (CTC). CTC uses this file to reprovision a node.

Each file is named with the site name string by default. The list of reported installation parameters depend on the system release selected for the designed network. You generally save this file after you analyze an Install network.

Use the following procedure to save the NE Update file:

- 
- Step 1** Click the **Networks Mgmt Tree** tab, and click the analyzed network.
- Step 2** In the Tasks Pane, click **NE Update**. The Network Element Update File dialog box appears.

- Step 3** Check the **Include wavelength parameters** check box to include trunk wavelength preprovisioning in the NE Update XML file. Do not check this box if the network on which you import the NE Update file is using ONS Software R7.0.0. If this option is checked, trunk wavelength is preprovisioned in CTC for all the TXP and MXP units required to support present traffic demands.



**Note** During project creation, selecting MSTP- Release 7.0 allows you to create projects for system releases 7.0.0 and 7.0.x. However, when importing the NE Update file on a node using system release 7.0.0, the node cannot read the NE Update XML file if Include wavelength parameters is checked.

- Step 4** To save the file in a different directory than the Destination Folder, click **Change** and navigate to the desired directory. Click **Save**.
- Step 5** Click **Finish**.
- Step 6** Click **Cancel** to close the window without saving a configuration setup file.

## 2.5.3 Viewing the Installation Parameters

The Installation Parameters reports shows the values to be set (provisioned) at installation time on each site in the network. These parameters are exported when you save the NE Update file and are used to automatically provision a node using CTC.

Use the following procedure to view the installation parameters after a network has been analyzed:

- Step 1** Complete one of the following:
- To view the Installation Parameters report for a network, click the **Networks Mgmt Tree** tab and click the network.
  - To view the Installation Parameters report for a site, click the **NtView Name** tab and click the site.
- Step 2** In the Tasks Pane, click **Installation Parameters**. The Installation Parameters tab appears (Figure 2-36). The ANS view subtab appears by default. This tab displays the Automatic Node Setup information.

**Figure 2-36 ANS View Subtab in the Installation Parameters Tab**

| Name  | Side | Position | Unit | Port # | Port ID | Port Label | Parameter                               | Value | Measurement Unit | M |
|-------|------|----------|------|--------|---------|------------|-----------------------------------------|-------|------------------|---|
| Site1 |      |          |      |        |         |            |                                         |       |                  |   |
|       | W    |          |      |        |         |            | dwdm::Tx::Power::Add-and-DropOutputP... | -0.1  | dBm              |   |
|       | E    |          |      |        |         |            | dwdm::Rx::Power::DropPowerBand          | -3.0  | dBm              |   |
|       | W    |          |      |        |         |            | dwdm::Tx::Threshold:FiberStageInput     | -3.0  | dBm              |   |
|       | W    |          |      |        |         |            | dwdm::Rx::Power::DropPowerBand          | -3.0  | dBm              |   |
|       | E    |          |      |        |         |            | dwdm::Tx::Power::Add-and-DropOutputP... | -0.1  | dBm              |   |
|       | E    |          |      |        |         |            | dwdm::Tx::Threshold:FiberStageInput     | -3.0  | dBm              |   |
|       | E    |          |      |        |         |            | dwdm::Rx::Power::Add-and-DropInputPo... | -3.7  | dBm              |   |
|       | W    |          |      |        |         |            | dwdm::Rx::Power::Add-and-DropInputPo... | -3.7  | dBm              |   |
| Site2 |      |          |      |        |         |            |                                         |       |                  |   |
|       | W    |          |      |        |         |            | dwdm::Tx::Power::Add-and-DropOutputP... | -0.1  | dBm              |   |
|       | E    |          |      |        |         |            | dwdm::Rx::Power::DropPowerBand          | -3.0  | dBm              |   |
|       | W    |          |      |        |         |            | dwdm::Tx::Threshold:FiberStageInput     | -3.0  | dBm              |   |
|       | W    |          |      |        |         |            | dwdm::Rx::Power::DropPowerBand          | -3.0  | dBm              |   |
|       | E    |          |      |        |         |            | dwdm::Tx::Power::Add-and-DropOutputP... | -0.1  | dBm              |   |
|       | E    |          |      |        |         |            | dwdm::Tx::Threshold:FiberStageInput     | -3.0  | dBm              |   |
|       | E    |          |      |        |         |            | dwdm::Rx::Power::Add-and-DropInputPo... | -3.7  | dBm              |   |
|       | W    |          |      |        |         |            | dwdm::Rx::Power::Add-and-DropInputPo... | -3.7  | dBm              |   |
| Site3 |      |          |      |        |         |            |                                         |       |                  |   |
|       | W    |          |      |        |         |            | dwdm::Rx::Power::Add-and-DropInputPo... | -3.7  | dBm              |   |

Table 2-9 describes the columns on the ANS view tab of the Installation Parameters report.

**Table 2-9 Installation Parameters Report ANS View Tab Columns**

| Column           | Description                                                                                                                                                                          |
|------------------|--------------------------------------------------------------------------------------------------------------------------------------------------------------------------------------|
| Name             | Displays the name of the site.                                                                                                                                                       |
| Side             | Displays the node interface: T (terminal), E (east), or W (west).                                                                                                                    |
| Position         | Displays the rack, shelf, and slot position of the card from which the patchcord originates.                                                                                         |
| Unit             | Displays the name of the card.                                                                                                                                                       |
| Port #           | Displays the port number from which the patchcord originates.                                                                                                                        |
| Port ID          | Displays the port ID.                                                                                                                                                                |
| Port Label       | Displays the name of the port.                                                                                                                                                       |
| Parameter        | Displays the name of the parameter to be set, such as RX Power Low.                                                                                                                  |
| Value            | Displays the name of the value to be set.                                                                                                                                            |
| Measurement Unit | Displays the measurement unit for the related installation parameter value, such as dBm.                                                                                             |
| Manual Set       | Indicates with a Yes or No which parameters must be manually set using the CTC interface. This column only applies to alarms. It does not apply to threshold crossing alerts (TCAs). |

**Step 3** Click the **ANP view** tab to view the Automatic Node Provisioning information. Table 2-10 describes the columns on the ANP view tab of the Installation Parameters report.

**Table 2-10** Installation Parameters Report ANP View Tab

| Category       | Description                                             |
|----------------|---------------------------------------------------------|
| Name           | Displays the name of the site.                          |
| Shelf ID       | Displays the shelf identifier.                          |
| Rack number    | Displays the rack number.                               |
| Rack position  | Identifies the rack position in the shelf.              |
| Slot position  | Identifies the slot position in the shelf for the card. |
| Equipment type | Displays the card type.                                 |

- Step 4** Click the **PP view** tab to view the Provisioning Parameters information. [Table 2-11](#) describes the columns on the PP view tab of the Installation Parameters report.

**Table 2-11** Installation Parameters Report PP View Tab

| Column        | Description                                         |
|---------------|-----------------------------------------------------|
| Name          | Displays the name of the site.                      |
| Shelf ID      | Displays the shelf identifier.                      |
| Slot position | Displays the slot number for the card with the PPM. |
| Port position | Displays the port number.                           |
| Ppm position  | Displays the PPM location on the card.              |
| Pp name       | Displays the name of the PPM.                       |
| value         | Displays the installation parameter value.          |

- Step 5** To close the Installation Parameters report, click the **X** on the top right of the Installation Parameters tab.

## 2.5.4 Viewing Internal Connections

Use the following procedure to view the network internal connections after a network has been analyzed. You can also use this procedure to view the patchcord connections between transponders and the Y-Cable Protection modules. The Y-Cable Protection position is defined using the rack and shelf number. The slots are numbered from left to right on each of the four modules that can be placed in a shelf.

- Step 1** Click the **Networks Mgmt Tree** tab, and click the analyzed network.
- Step 2** In the Tasks Pane, click **Internal Connections**. The Internal Connections tab appears ([Figure 2-37](#)).

Figure 2-37 Internal Connections Tab

| Name  | Position                       | Unit         | Port label | Attenuator   | Position            |
|-------|--------------------------------|--------------|------------|--------------|---------------------|
| Cable | Rack 1.ONS 15454 ANSI Shelf... | AD-2C-58.1   | EXP TX     |              | Rack 1.ONS 15454 AN |
| Cable | Rack 1.ONS 15454 ANSI Shelf... | AD-1C-58.1   | EXP TX     |              | Rack 1.ONS 15454 AN |
| Cable | Rack 1.ONS 15454 ANSI Shelf... | AD-2C-58.1   | AD_TX1     | 15216-ATT... | Rack 1.ONS 15454 AN |
| Cable | Rack 1.ONS 15454 ANSI Shelf... | TXP_MR_10E_C | DWDM-TX    |              | Rack 1.ONS 15454 AN |
| Cable | Rack 1.ONS 15454 ANSI Shelf... | AD-2C-58.1   | AD_TX0     | 15216-ATT... | Rack 1.ONS 15454 AN |
| Cable | Rack 1.ONS 15454 ANSI Shelf... | TXP_MR_10E_C | DWDM-TX    |              | Rack 1.ONS 15454 AN |
| Cable | Rack 1.ONS 15454 ANSI Shelf... | AD-1C-58.1   | AD_TX0     | 15216-ATT... | Rack 1.ONS 15454 AN |
| Cable | Rack 1.ONS 15454 ANSI Shelf... | TXP_MR_10E_C | DWDM-TX    |              | Rack 1.ONS 15454 AN |
| Cable | Rack 1.ONS 15454 ANSI Shelf... | OSC-CSM      | COM TX     |              | Rack 1.ONS 15454 AN |
| Cable | Rack 1.ONS 15454 ANSI Shelf... | AD-2C-58.1   | COM TX     |              | Rack 1.ONS 15454 AN |
| Cable | Rack 1.ONS 15454 ANSI Shelf... | OSC-CSM      | COM TX     |              | Rack 1.ONS 15454 AN |
| Cable | Rack 1.ONS 15454 ANSI Shelf... | AD-1C-58.1   | COM TX     |              | Rack 1.ONS 15454 AN |

Table 2-12 lists the columns in the Internal Connections tab and their descriptions. Click a columns to sort the table information by that column.

- Click the **Patchcord installation view** subtab to view all the patchcord connections that the installer has to mechanically cable within the site between the different ports of the cards.
- Click the **SW Provisioning view** subtab to view the patchcord representation on the local Cisco Transport Controller interface. This subtab contains all the connections to be manually set or removed with respect to the default connections that are automatically generated by the software running on the node.

Table 2-12 Internal Connections Tab Columns

| Column Name | Description                                                                                                                                                                |
|-------------|----------------------------------------------------------------------------------------------------------------------------------------------------------------------------|
| Name        | Displays the name of the site. On the SW provisioning view subtab, this column indicates whether the connection should be manually set using the CTC interface or removed. |
| Position-1  | Displays the rack, shelf, and slot position of the card from which the patchcord originates.                                                                               |
| Unit-1      | Displays the name of the card.                                                                                                                                             |

**Table 2-12 Internal Connections Tab Columns (continued)**

| Column Name  | Description                                                                                                                                                                                                                                  |
|--------------|----------------------------------------------------------------------------------------------------------------------------------------------------------------------------------------------------------------------------------------------|
| Port Num     | (SW provisioning view subtab only) Displays the port number where the patchcord terminates.                                                                                                                                                  |
| Port ID-1    | (SW provisioning view subtab only) Displays the port ID.                                                                                                                                                                                     |
| Port label-1 | Displays the name of the port.                                                                                                                                                                                                               |
| Attenuator   | When indicated, this is the product ID of the bulk attenuator to be equipped on this connection. It also reports when an internal attenuator must be placed between the DC-TX and DC-RX ports on the preamplifier (when no DCU is equipped). |
| Position-2   | Displays the rack, shelf, and slot position of the card where the patchcord terminates.                                                                                                                                                      |
| Unit-2       | Displays the name of the card.                                                                                                                                                                                                               |
| Port Num     | (SW provisioning view subtab only) Displays the port number where the patchcord terminates.                                                                                                                                                  |
| Port ID-2    | (SW provisioning view subtab only) Displays the port ID.                                                                                                                                                                                     |
| Port Label-2 | Displays the name of the port.                                                                                                                                                                                                               |
| P/F          | Displays whether the connection relates to a present or forecast circuit.                                                                                                                                                                    |

- Step 3** To export the information to an external file, click **Export**. In the Internal connections export dialog box, type the name of the file and navigate to the desired folder. Click **Save**.
- Step 4** To close the Internal Connections tab, click the **X** in the upper right corner of the tab.

## 2.5.5 Viewing the Traffic Matrix Report

The Traffic Matrix report displays the point-to-point, P-ring, and ROADM channel data. Use the following procedure to view the traffic matrix report:

- Step 1** Complete one of the following:
- To view the Traffic Matrix report for a network, click the **Networks Mgmt Tree** tab and click the network.
  - To view the Traffic Matrix report for a site, click the **NtView Name** tab and click the site.
- Step 2** In the Tasks Pane under Reports, click **Traffic Matrix**. The Traffic Matrix tab appears. A default query opens.



**Figure 2-38 Traffic Matrix Tab**

Each row in the tab shows the performance of one optical path. Table 2-18 describes the information in the columns. The Traffic Matrix report displays separate rows for the TX and RX direction of the optical channels.



**Note** To add a column to the report, right-click a column and choose the column name from the shortcut menu. The column names with checks in the shortcut menu appear on the report. To remove a column, right-click and choose the column (checked) from the shortcut menu.

**Table 2-13 Traffic Matrix Tab Columns**

| Column Label           | Description                                                                                                                                         |
|------------------------|-----------------------------------------------------------------------------------------------------------------------------------------------------|
| Service Demand         | Categorizes each demand type (Point-to-Point, P-ring, and ROADM). Click the plus (+) sign by a demand type to expand and show the optical channels. |
| Service Circuit        | Displays the optical channel label; for example, Site1-Site2.                                                                                       |
| OCH CC Source          | Displays the site name for the optical channel source.                                                                                              |
| OCH CC Source Position | Displays the rack, shelf, and slot identifiers for the source of the optical channel. The format of the field is Rack.Shelf.Slot.                   |
| OCH CC Source Unit     | Displays the unit name for the optical channel source.                                                                                              |
| OCH CC Source Port     | Displays the port for the source of the optical channel; for example, Client RX.                                                                    |
| OCH CC Dst             | Displays the site name for the optical channel destination.                                                                                         |
| OCH CC Dst Position    | Displays the rack, shelf, and slot identifiers for the destination of the optical channel. The format of the field is Rack.Shelf.Slot.              |
| OCH CC Dst Unit        | Displays the product ID for the optical channel destination.                                                                                        |

**Table 2-13 Traffic Matrix Tab Columns (continued)**

| Column Label        | Description                                                                                                                                                                                                                                                                                                                                            |
|---------------------|--------------------------------------------------------------------------------------------------------------------------------------------------------------------------------------------------------------------------------------------------------------------------------------------------------------------------------------------------------|
| OCH CC Dst Port     | Displays the port for the destination of the optical channel; for example, Client TX.                                                                                                                                                                                                                                                                  |
| A/D Source          | Displays the site name for the add/drop channel source.                                                                                                                                                                                                                                                                                                |
| A/D Source Position | Displays the rack, shelf, and slot identifiers for the source of the add/drop channel. The format of the field is Rack.Shelf.Slot.                                                                                                                                                                                                                     |
| A/D Source Unit     | Displays the unit name for the add/drop channel source.                                                                                                                                                                                                                                                                                                |
| A/D Source Port     | Displays the port for the source of the add/drop channel; for example, Client RX.                                                                                                                                                                                                                                                                      |
| A/D Dst             | Displays the site name for the add/drop channel destination.                                                                                                                                                                                                                                                                                           |
| A/D Dst Position    | Displays the rack, shelf, and slot identifiers for the destination of the add/drop channel. The format of the field is Rack.Shelf.Slot.                                                                                                                                                                                                                |
| A/DDst Unit         | Displays the product ID for the add/drop channel destination.                                                                                                                                                                                                                                                                                          |
| A/D Dst Port        | Displays the port for the destination of the add/drop channel; for example, Client TX.                                                                                                                                                                                                                                                                 |
| Cl. Serv. Type      | Displays the client service type of the demand; for example, OC-48.                                                                                                                                                                                                                                                                                    |
| Protection          | Displays the protection type of the demand; for example, P-ring or Y-cable.                                                                                                                                                                                                                                                                            |
| Wavelength          | Displays the wavelength of the optical channel.                                                                                                                                                                                                                                                                                                        |
| Opt Bypass          | Identifies where the optical channel is dropped and reinserted when it is not terminated on a TXP or MXP card (optical bypass). If “none” appears in the Op Bypass column, no optical bypass is defined for the optical channel.                                                                                                                       |
| DWDM Interface Type | Identifies the DWDM interface type that is used for the optical channel: <ul style="list-style-type: none"> <li>• Transponder indicates that an MSTP transponder, an MSTP muxponder, or a DWDM pluggable port module is used for the optical channel.</li> <li>• Line Card indicates that an ITU line card is used for the optical channel.</li> </ul> |
| DWDM Card Type      | Identifies the type of transponder or line card used for the optical channel.                                                                                                                                                                                                                                                                          |

**Step 3** To create a new query, click **New Query** to open the Query Dialog (Figure 2-39). The Query Dialog allows you to filter the optical results using a variety of parameters and templates.

Figure 2-39 Query Dialog

The screenshot shows the 'Query Dialog' window. The 'Criteria Definition' section includes the following fields:

- Group: Network
- Demand: Any
- DWDM Card Type: Any
- Source: Any
- Destination: Any
- Wavelength: Auto
- Alarm: Any
- P/F: P
- Virtual: No

The 'Query Preview' section displays the following criteria:

Group = Network :: Demand = Any :: Client = Any :: Connectivity = Any to Any site :: Wavelength = Auto :: Alarm = Any :: P/F = P :: Virtual = No

Buttons at the bottom: Reset Query, Run Query, Cancel.

**Step 4** To perform a query using individual parameters, select the desired parameters from the drop-down lists in the Query Definition area. The selected parameters appear in the Query Preview area at the bottom of the screen. [Table 2-14](#) describes the fields in the Query Dialog.

Table 2-14 Query Dialog Fields

| Field Label    | Description                                                                                                                                                     |
|----------------|-----------------------------------------------------------------------------------------------------------------------------------------------------------------|
| Group          | Allows you to filter the report to include only the data in the selected group. You can also view groups in the Project Explorer view under the network folder. |
| Demand         | Allows you to filter the report to include only the data in the selected demand. The demand field is available only when you select a specific traffic group.   |
| DWDM Card Type | Allows you to filter the report to include only the data in the selected DWDM card type.                                                                        |
| Source         | Allows you to filter the report to include only the results of incoming/outgoing services to or from a specific source site.                                    |
| Destination    | Allows you to filter the report to include only the results of incoming/outgoing services to or from a specific destination site.                               |
| Wavelength     | Allows you to filter the report to include only services using the specified wavelength.                                                                        |
| Alarm          | Allows you to filter the report to include only services flagged with a green, yellow, orange, or red indicator.                                                |
| P/F            | Allows you to filter the report to include only present services, only forecast services, or both.                                                              |
| Virtual        | Allows you to filter the report to include or exclude virtual channels in the Optical Results Table.                                                            |

- Step 5** Choose one of the following, as needed:
- Click **Run Query**. The window closes, and the query results appear in the Traffic Matrix tab (Figure 2-38). The parameters of the query appear in the horizontal area just below the button bar.
  - Click **Reset Query** to clear your selections in the Query Dialog.
  - Click **Close** to close the window without running a query.
- Step 6** To close the Traffic Matrix report, click the **X** in the upper right corner of the tab.

## 2.5.6 Displaying the Layout

Use the following procedure to view a graphical representation of each site in an analyzed network:

- Step 1** Click the **NtView Name** tab and click the desired site.
- Step 2** In the Tasks Pane, click **Layout**. The Layout tab appears (Figure 2-40). To change sites, choose the desired site from the drop-down list.

**Figure 2-40** Layout Report (Rack View)

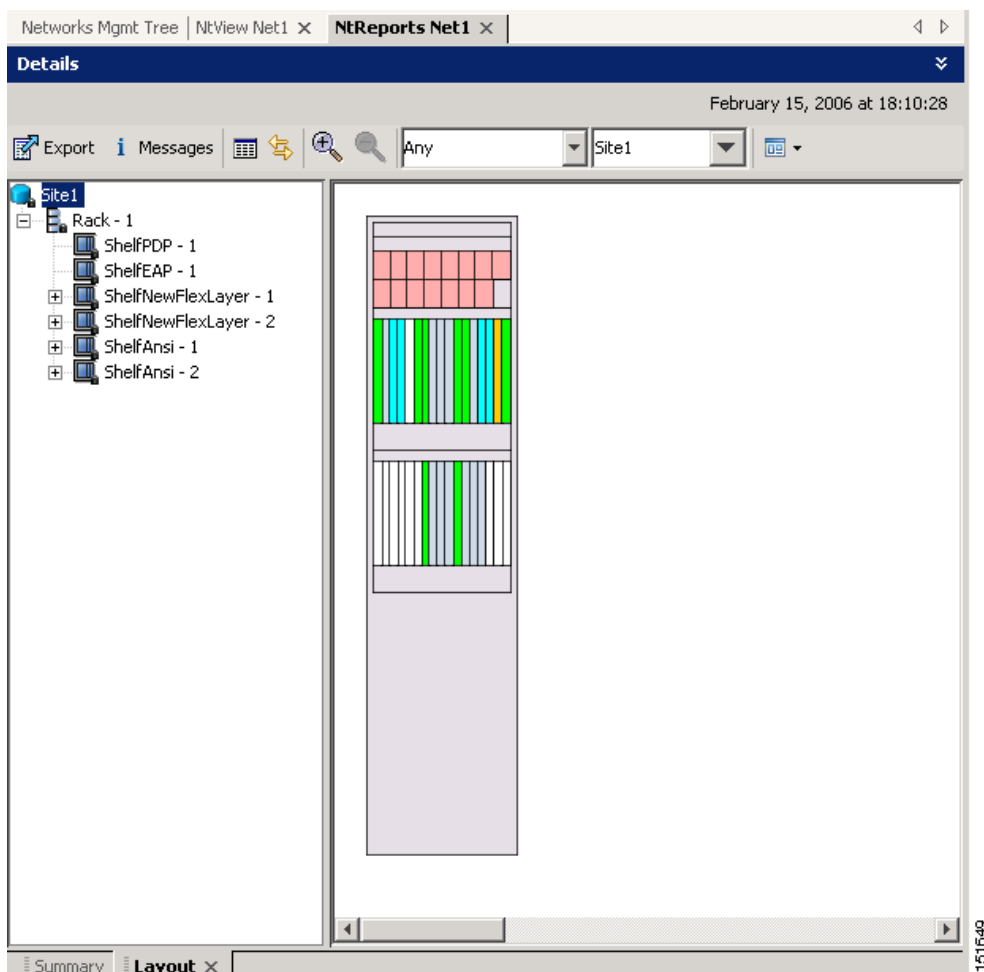

- Step 3** From the **Site** drop-down list, choose the site in the network to display in the layout report.
- Step 4** In the tree view on the left of the tab, right-click a rack and choose **Expand** to view a list of all shelves and cards in the rack.
- Step 5** Click the desired rack or shelf to view it in the layout graphic. [Figure 2-41](#) displays the shelf view.

**Figure 2-41** Layout Report (Shelf View)

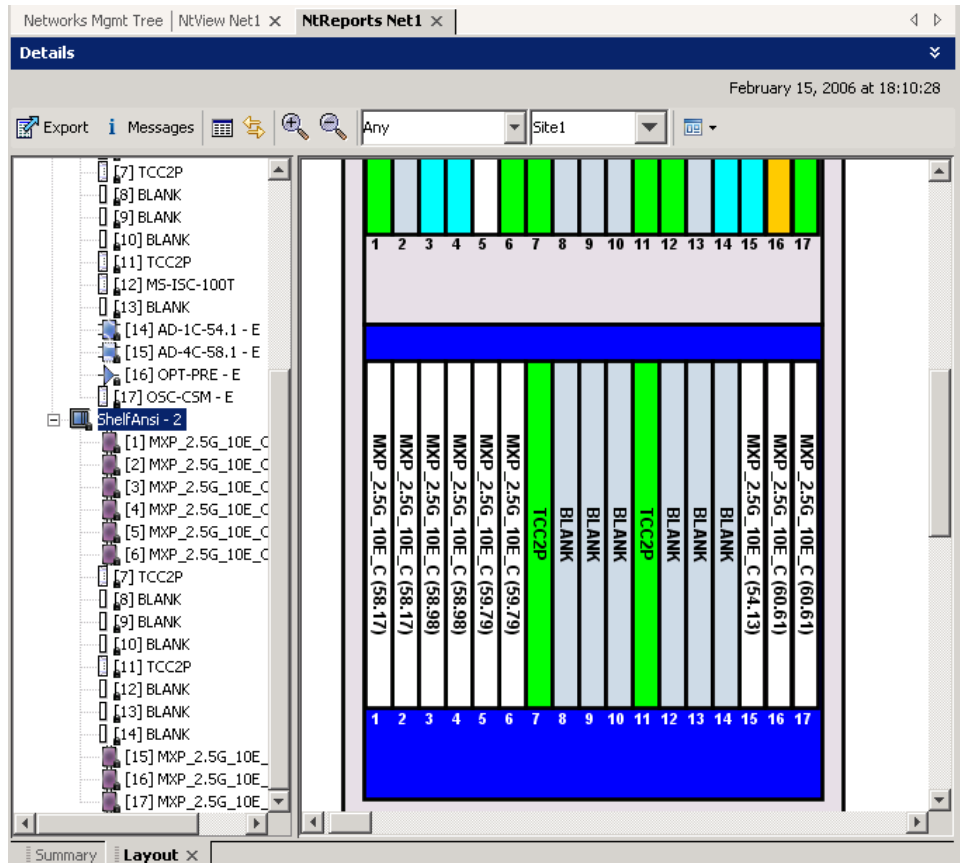

- Step 6** To view details about a card, double-click the card. The Details dialog box opens with client information:

- **Label**—Displays the name of the card.
- **Product ID**—Displays the product ID of the card.
- **Service Category**—Future use.
- **Description**—Provides a brief description of the card functionality.
- **Price**—Lists the price for the card based on the price list selected during project creation.
- **ITU Channel**—Identifies the ITU channel wavelength for the card.

For transponder and muxponder cards, click the **Modules** subtab in the Details dialog box to view which pluggable port modules are to be used for each TXP/MXP unit:

- **P/F**—P refers to pluggable port modules that support the present client demand, while F refers to pluggable port modules that support the future client demand.
- **Module PID**—Displays the pluggable port module product ID.

- **Ch#**—Displays the number of the port on the unit and identifies where the pluggable port module is to be installed.

Click **Close** to close the Details dialog box.

**Step 7** To filter the layout display, choose one of the following from the drop-down list:

- **Any**—Displays all cards for both the present and forecast traffic demand.
- **Present**—Displays cards for only the present traffic demand.
- **Locked & Unlocked**—Highlights the locked and unlocked cards in the layout.
- **Alarmed**—Highlights the alarmed cards in the layout.

**Step 8** After network analysis, all items are in locked mode. To unlock cards so that Cisco TransportPlanner can rearrange the layout to optimize slot usage during network analysis, right-click locked card in the rack tree and choose **Unlock**.



---

**Note** You can unlock only on Upgrade networks in the Design state.

---

**Step 9** To export the graphical representation of the layout in JPEG format, click **Export**. In the Layout export dialog box, type the name of the file and navigate to the desired folder. Click **Save**.

**Step 10** To zoom the layout graphic in or out, click the Zoom In and Zoom Out icons. For more information about the Cisco TransportPlanner icons, see [Appendix A, “GUI Information and Shortcuts.”](#)

**Step 11** To close the Layout report, click the **X** in the upper right corner of the tab.

---

## 2.5.7 Viewing Power Consumption from the Layout Report

Use the following procedure to view the power consumption for each unit of equipment in a site. Power consumption is available in report form from the Layout report.

---

**Step 1** Click the **NtView Name** tab and click the desired site.

**Step 2** In the Tasks Pane, click **Layout**. The Layout tab appears ([Figure 2-40 on page 2-74](#)). To change sites, choose the desired site from the drop-down list.

**Step 3** Click the View layout as table icon in the report tool bar. The Layout Table report appears ([Figure 2-42](#)).

Figure 2-42 Power Consumption

| Name                     | Position  | Description                                                 | Max power consumption (W) |
|--------------------------|-----------|-------------------------------------------------------------|---------------------------|
| Rack                     | Rack - 1  |                                                             | 181.00                    |
| Power Distribution Panel | Shelf - 1 |                                                             | 0.00                      |
| EAP Mechanical Frame     | Shelf - 1 | Ethernet Adapter Panel Mechanical Frame                     | 0.00                      |
| ONS 15454 ANSI Shelf     | Shelf - 1 | 15454 SA HD NER53 ANSI w/ RCA and Ship Kit                  | 181.00                    |
| OSC-CSM                  | Slot 1    | ONS 15454 Combiner and Separator with OSC Module            | 27.00                     |
| AD-1C                    | Slot 2    | ONS 15454 OADM - 1 Chn - 100GHz - 1558.17                   | 25.00                     |
| TXP_MR_10E_y             | Slot 3    | 15454 10G Multi-Rate Transponder- EFEC- Full C-Band Tunable | 42.00                     |
| Blank                    | Slot 4    | Empty slot Filler Panel                                     | 0.00                      |
| Blank                    | Slot 5    | Empty slot Filler Panel                                     | 0.00                      |
| MS-15C-100T              | Slot 6    | MultiShelf Management Integrated Switch Card                | 0.00                      |
| TCC2P                    | Slot 7    | Timing Communications Control Two Plus, I-Temp              | 30.00                     |
| Blank                    | Slot 8    | Empty slot Filler Panel                                     | 0.00                      |
| Blank                    | Slot 9    | Empty slot Filler Panel                                     | 0.00                      |
| Blank                    | Slot 10   | Empty slot Filler Panel                                     | 0.00                      |
| TCC2P                    | Slot 11   | Timing Communications Control Two Plus, I-Temp              | 30.00                     |
| MS-15C-100T              | Slot 12   | MultiShelf Management Integrated Switch Card                | 0.00                      |
| Blank                    | Slot 13   | Empty slot Filler Panel                                     | 0.00                      |
| Blank                    | Slot 14   | Empty slot Filler Panel                                     | 0.00                      |
| Blank                    | Slot 15   | Empty slot Filler Panel                                     | 0.00                      |
| Blank                    | Slot 16   | Empty slot Filler Panel                                     | 0.00                      |
| OSC-CSM                  | Slot 17   | ONS 15454 Combiner and Separator with OSC Module            | 27.00                     |
| 1RU Air Ramp             | Shelf - 1 | ONS 15454 Air Ramp / Baffle for the ANSI Chassis            | 0.00                      |

Table 2-15 describes the information in the columns.

Table 2-15 Layout Table (Power Consumption) Columns

| Column Label                  | Description                                                                                                                                                                                                                                                                  |
|-------------------------------|------------------------------------------------------------------------------------------------------------------------------------------------------------------------------------------------------------------------------------------------------------------------------|
| Name                          | Lists the equipment at the site.                                                                                                                                                                                                                                             |
| Position                      | Identifies the rack, shelf, or slot location for applicable units of equipment.                                                                                                                                                                                              |
| Description                   | Describes each equipment type.                                                                                                                                                                                                                                               |
| Max Power Consumption (W)     | Displays the maximum power consumption for each unit of equipment.<br><b>Note</b> For transponder/muxponder cards with pluggable port modules, the maximum power consumption shown is for the board fully equipped with the maximum number of pluggable port modules.        |
| Average Power Consumption (W) | Displays the average power consumption for applicable units of equipment.<br><b>Note</b> For transponder/muxponder cards with pluggable port modules, the average power consumption shown is for the board fully equipped with the maximum number of pluggable port modules. |

**Step 4** To export power consumption data, click **Export**. The Layout table export dialog box appears. Type the name of the file and navigate to the desired folder. Click **Save**.

**Step 5** Click **Close** to close the Layout Table report.

## 2.5.8 Viewing the Link Availability Report

Cisco TransportPlanner determines link availability based on unit failure rate and time to repair. Use the following procedure to view the Link Availability report:

- Step 1** Complete one of the following:
- To view the Link Availability report for a network, click the **Networks Mgmt Tree** tab and click the network.
  - To view the Link Availability report for a site, click the **NtView Name** tab and click the site.
- Step 2** In the Tasks Pane, click **Link Availability**. The Link Availability tab appears (Figure 2-43).

**Figure 2-43 Link Availability Report**

| Group    | Serv. Circuit | P/F | DWDM Card Type        | Protection | Cl. Serv. Type | Source | Destination ... | L. A. (%) |
|----------|---------------|-----|-----------------------|------------|----------------|--------|-----------------|-----------|
| P-Ring_1 | Site1-Site2   | P/F | TXP_MR_10E_y - w/EFEC | P-Ring     | 10GE LAN PHY   | Site1  | Site2           | 0.99999   |
|          | Site2-Site3   | P/F | TXP_MR_10E_y - w/EFEC | P-Ring     | 10GE LAN PHY   | Site2  | Site3           | 0.99999   |
|          | Site3-Site1   | P/F | TXP_MR_10E_y - w/EFEC | P-Ring     | 10GE LAN PHY   | Site3  | Site1           | 0.99999   |

Each row in the tab shows the performance of one optical path. Table 2-16 describes the information in the columns.

**Table 2-16 Link Availability Tab Columns**

| Column Label                   | Description                                                                                                                                         |
|--------------------------------|-----------------------------------------------------------------------------------------------------------------------------------------------------|
| Group                          | Categorizes each demand type (Point-to-Point, P-ring, and ROADM). Click the plus (+) sign by a demand type to expand and show the optical channels. |
| Serv. Circuit                  | Displays the optical channel label; for example, Site1-Site2.                                                                                       |
| P/F                            | Identifies whether the channel is present and forecast (P/F) or forecast (F).                                                                       |
| DWDM Card Type                 | Identifies the type of transponder or line card used for the optical channel.                                                                       |
| Protection                     | Displays the protection type of the demand; for example, P-ring or Y-cable.                                                                         |
| Cl. Serv. Type                 | Displays the client service type of the demand; for example, OC-48.                                                                                 |
| Source                         | Displays the site name for the optical channel source.                                                                                              |
| Destination                    | Displays the site name for the optical channel destination.                                                                                         |
| Link Availability (% Complete) | Displays the link availability percentage. Link availability is calculated based on the failure rate and time to repair.                            |

- Step 3** Click **New Query** to open the Query Dialog (Figure 2-39 on page 2-73). The Query Dialog allows you to filter the link availability using a variety of parameters.
- Step 4** To perform a query using individual parameters, select the desired parameters from the drop-down lists in the Query Definition area. The selected parameters appear in the Query Preview area at the bottom of the screen. Table 2-17 describes the fields in the Query Dialog.



**Table 2-17 Query Dialog Fields**

| Field Label    | Description                                                                                                                                                     |
|----------------|-----------------------------------------------------------------------------------------------------------------------------------------------------------------|
| Group          | Allows you to filter the report to include only the data in the selected group. You can also view groups in the Project Explorer view under the network folder. |
| Demand         | Allows you to filter the report to include only the data in the selected demand. The demand field is available only when you select a specific traffic group.   |
| DWDM Card Type | Allows you to filter the report to include only the data in the selected DWDM card type.                                                                        |
| Source         | Allows you to filter the report to include only the results of incoming/outgoing services to or from a specific source site.                                    |
| Destination    | Allows you to filter the report to include only the results of incoming/outgoing services to or from a specific destination site.                               |
| Wavelength     | Allows you to filter the report to include only services using the specified wavelength.                                                                        |
| P/F            | Allows you to filter the report to include only present services, only forecast services, or both.                                                              |

**Step 5** Choose one of the following, as needed:

- Click **Run Query**. The window closes, and the query results appear in the Link Availability tab. The parameters of the query appear in the horizontal area just below the button bar.
- Click **Reset Query** to clear your selections in the Query Dialog.
- Click **Close** to close the window without running a query.

**Step 6** To close the Link Availability report, click the **X** in the upper right corner of the tab.

## 2.5.9 Viewing Optical Results

Use the following procedure to view the optical results of the network that you created and analyzed:

**Step 1** Complete one of the following:

- To view the Optical Results report for a network, click the **Networks Mgmt Tree** tab and click the network.
- To view the Optical Results report for a site, click the **NtView Name** tab and click the site.

**Step 2** In the Tasks Pane, click **Optical Results**. The Optical Results tab appears (Figure 2-44).

Figure 2-44 Optical Results Tab

| Name                                                                                                                                                                                  | Group       | Protect     | SOL | EOL | SE | P/F | Source  | Destination |
|---------------------------------------------------------------------------------------------------------------------------------------------------------------------------------------|-------------|-------------|-----|-----|----|-----|---------|-------------|
| <ul style="list-style-type: none"> <li>OCH Trail - 1 <ul style="list-style-type: none"> <li>DWDM Trunk – Far End</li> <li>DWDM Trunk – Near End</li> </ul> </li> </ul>                | Site1-Site3 | Unprotected | ●   | ●   | ●  | P/F | Site3.E | Site1.W     |
| <ul style="list-style-type: none"> <li>OCHCC</li> <li>Site1 - Site3_1_1</li> </ul>                                                                                                    | Site1-Site3 | Unprotected |     |     |    | P/F | Site1.W | Site3.E     |
| <ul style="list-style-type: none"> <li>OCH Trail - 2 <ul style="list-style-type: none"> <li>DWDM Trunk – Far End</li> <li>DWDM Trunk – Near End</li> </ul> </li> </ul>                | P-Ring_1    | P-Ring      | ●   | ●   | ●  | P/F | Site1.E | Site2.W     |
| <ul style="list-style-type: none"> <li>OCHCC</li> <li>P-Ring 1 - Site1-Site2</li> </ul>                                                                                               | P-Ring_1    | P-Ring      |     |     |    | P/F | Site2.W | Site1.E     |
| <ul style="list-style-type: none"> <li>OCH Trail - 3 <ul style="list-style-type: none"> <li>DWDM Trunk – Far End</li> <li>DWDM Trunk – Near End</li> </ul> </li> </ul>                | P-Ring_1    | P-Ring      | ●   | ●   | ●  | P/F | Site2.E | Site3.W     |
| <ul style="list-style-type: none"> <li>OCHCC</li> <li>OCH Trail - 4 <ul style="list-style-type: none"> <li>DWDM Trunk – Far End</li> <li>DWDM Trunk – Near End</li> </ul> </li> </ul> | P-Ring_1    | P-Ring      | ●   | ●   | ●  | P/F | Site3.W | Site2.E     |
| <ul style="list-style-type: none"> <li>OCHCC</li> <li>OCH Trail - 4 <ul style="list-style-type: none"> <li>DWDM Trunk – Far End</li> <li>DWDM Trunk – Near End</li> </ul> </li> </ul> | P-Ring_1    | P-Ring      | ●   | ●   | ●  | P/F | Site3.E | Site1.W     |
| <ul style="list-style-type: none"> <li>OCHCC</li> <li>OCH Trail - 4 <ul style="list-style-type: none"> <li>DWDM Trunk – Far End</li> <li>DWDM Trunk – Near End</li> </ul> </li> </ul> | P-Ring_1    | P-Ring      | ●   | ●   | ●  | P/F | Site1.W | Site3.E     |

Each row in the tab shows the performance of one optical path. Table 2-18 describes the information in the columns.

Table 2-18 Optical Results Tab Columns

| Column Label | Description                                                                                                                                                                                                                                                                                                                                                                                                                                                                                                                                |
|--------------|--------------------------------------------------------------------------------------------------------------------------------------------------------------------------------------------------------------------------------------------------------------------------------------------------------------------------------------------------------------------------------------------------------------------------------------------------------------------------------------------------------------------------------------------|
| Name         | Displays the identification number automatically given to each path in the order that the channels were entered into the design.                                                                                                                                                                                                                                                                                                                                                                                                           |
| Group        | Identifies the demand group for the optical channel.                                                                                                                                                                                                                                                                                                                                                                                                                                                                                       |
| Protect      | Displays the protection type of the channel. For a protected channel, both paths are shown. The path leaving the east side of the source is shown first.                                                                                                                                                                                                                                                                                                                                                                                   |
| SOL          | Displays the results summary of the analysis run with Start of Life fiber loss values. The indicator shows the optical performance for the each direction of the bidirectional OCH Trail. Green indicates success, yellow indicates success with a marginal failure risk (between 0 and 16 percent), orange indicates that the channel has a higher risk of failure (between 16 and 50 percent), and red indicates failure.                                                                                                                |
| EOL          | Displays the results summary of the analysis run with End of Life fiber loss values. The indicator shows the optical performance for the each direction of the bidirectional Optical Channel Trail (OCH Trail). The indicator shows the optical performance for the path at the end of the fiber's life. Green indicates success, yellow indicates success with a marginal failure risk (between 0 and 16 percent), orange indicates that the channel has a higher risk of failure (between 16 and 50 percent), and red indicates failure. |

**Table 2-18** *Optical Results Tab Columns (continued)*

| Column Label             | Description                                                                                                                                                                                                                         |
|--------------------------|-------------------------------------------------------------------------------------------------------------------------------------------------------------------------------------------------------------------------------------|
| SE                       | Indicates a system-related error exists that may impact the analysis of the design. If the indicator is red, review the messages reported at the end of the analysis or determine which units or sites are having a problem.        |
| Regeneration             | Displays the status of the single channel nonlinear effect (NLE) alarm check. Green indicates check passed. Yellow indicates marginal NLE; orange indicates consistent NLE, and Red indicates failure.                              |
| Multi-channel NLE Status | Displays the status of the multiple channel NLE alarm check. Green indicates check passed. Yellow indicates marginal NLE; orange indicates consistent NLE, and red indicates failure.                                               |
| Wavelength               | Displays the assigned wavelength of the optical path.                                                                                                                                                                               |
| P/F                      | Displays the present/forecast services indication.                                                                                                                                                                                  |
| Source                   | Displays the name of the source site and side; for example, Site 1-E.                                                                                                                                                               |
| Destination              | Displays the name of the destination site and side; for example, Site 1-E.                                                                                                                                                          |
| Span (km)                | Displays the total span length (source -> destination) for this path in kilometers.                                                                                                                                                 |
| Tx Type                  | Displays the type of DWDM unit or pluggable port module used for the specific OCH Trail.                                                                                                                                            |
| BER target               | Displays the bit error rate (BER) target for this channel based on the capability of the channel's optical interface. It is 1.0E-15 for the interfaces using forward error correction (FEC) and 1.0E-12 for interfaces without FEC. |
| SOL OSNR (dB)            | Displays the start of life average OSNR value at the receiver. OSNR refers to the selected resolution bandwidth (RBW) bandwidth.                                                                                                    |
| EOL OSNR (dB)            | Displays the end of life average OSNR value at the receiver. OSNR refers to the selected RBW bandwidth.                                                                                                                             |
| SOL OSNR Margin (dB)     | Displays the SOL OSNR margin calculation, which is the difference between the OSNR value at a certain power of the working point of the receiver client and the working area boundary.                                              |
| EOL OSNR Margin (dB)     | Displays the EOL OSNR margin calculation, which is the difference between the OSNR value at a certain power of the working point of the receiver client and the working area boundary.                                              |
| SOL RX (dBm)             | Displays the SOL received average power at the destination site in dBm.                                                                                                                                                             |
| EOL RX (dBm)             | Displays the EOL received average power at the destination site in dBm.                                                                                                                                                             |
| SOL Power margin (dB)    | Displays the SOL power budget margin at the receiver in decibels. It is defined as the offset between the receiver working point and the BER curve with margin. A positive value indicates no power problems.                       |
| EOL Power margin (dB)    | Displays the EOL power budget margin at the receiver in decibels. It is defined as the offset between the receiver working point and the BER curve with margin. A positive value indicates no power problems.                       |
| SOL Overload (dB)        | Displays the SOL overload margin at the receiver in decibels. A positive value indicates no overload problems.                                                                                                                      |
| EOL Overload (dB)        | Displays the EOL overload margin at the receiver in decibels. A positive value indicates no overload problems.                                                                                                                      |
| RX atten                 | Displays the attenuation at the input of the receiver.                                                                                                                                                                              |

**Table 2-18** Optical Results Tab Columns (continued)

| Column Label      | Description                                                                                                                                                                                                                                                                                                                                                                                                                        |
|-------------------|------------------------------------------------------------------------------------------------------------------------------------------------------------------------------------------------------------------------------------------------------------------------------------------------------------------------------------------------------------------------------------------------------------------------------------|
| PMD (ps)          | Displays the calculated total PMD for each circuit. This total includes all the PMD components for the OCH Trail, including fiber and DWDM units on the path. If the overall PMD for the link overcomes the maximum allowed, the PMD value is colored red. The maximum allowed value depends on the client interface. For these special cases, the network must be manually resolved by contacting a Cisco optical sales engineer. |
| Latency           | Displays the latency time for the current circuit. This value includes all the latency components for the OCH Trail, including fiber and DWDM units on the path.                                                                                                                                                                                                                                                                   |
| Filtering Penalty | Displays the value of the penalties caused by the different filter types (OADM, ROADM, and arrayed waveguide grating, [AWG]).                                                                                                                                                                                                                                                                                                      |

**Step 3** Click **New Query** to open the Query Dialog (Figure 2-39 on page 2-73). The Query Dialog allows you to filter the optical results using a variety of parameters.

**Step 4** To perform a query using individual parameters, select the desired parameters from the drop-down lists in the Query Definition area. The selected parameters appear in the Query Preview area at the bottom of the screen. Table 2-19 describes the fields in the Query Dialog.

**Table 2-19** Query Dialog Fields

| Field Label    | Description                                                                                                                                                     |
|----------------|-----------------------------------------------------------------------------------------------------------------------------------------------------------------|
| Group          | Allows you to filter the report to include only the data in the selected group. You can also view groups in the Project Explorer view under the network folder. |
| Demand         | Allows you to filter the report to include only the data in the selected demand. The demand field is available only when you select a specific traffic group.   |
| DWDM Card Type | Allows you to filter the report to include only the data in the selected DWDM card type.                                                                        |
| Source         | Allows you to filter the report to include only the results of incoming/outgoing services to or from a specific source site.                                    |
| Destination    | Allows you to filter the report to include only the results of incoming/outgoing services to or from a specific destination site.                               |
| Wavelength     | Allows you to filter the report to include only services using the specified wavelength.                                                                        |
| Alarm          | Allows you to filter the report to include only services flagged with a green, yellow, orange, or red indicator.                                                |
| P/F            | Allows you to filter the report to include only present services, only forecast services, or both.                                                              |
| Virtual        | Allows you to filter the report to include or exclude virtual channels in the Optical Results Table.                                                            |

**Step 5** Choose one of the following, as needed:

- Click **Run Query**. The window closes, and the query results appear in the Optical Results tab. The parameters of the query appear in the horizontal area just below the button bar.

- Click **Reset Query** to clear your selections in the Query Dialog.
- Click **Close** to close the window without running a query.

**Step 6** To close the Optical Results report, click the **X** in the upper right corner of the tab.

## 2.5.10 Viewing Wavelength Routing

Use the following procedure to view the wavelength routing map for an analyzed network:

**Step 1** Click the **Networks Mgmt Tree** tab, and click the analyzed network.

**Step 2** In the Tasks Pane, click **Wavelength Routing**. The Wavelength Routing tab appears (Figure 2-45). Each wavelength supported by the platform is represented by a row.



**Note** ROADM (Any-to-Any) demands are not shown in this report.

**Figure 2-45 Wavelength Routing Tab**

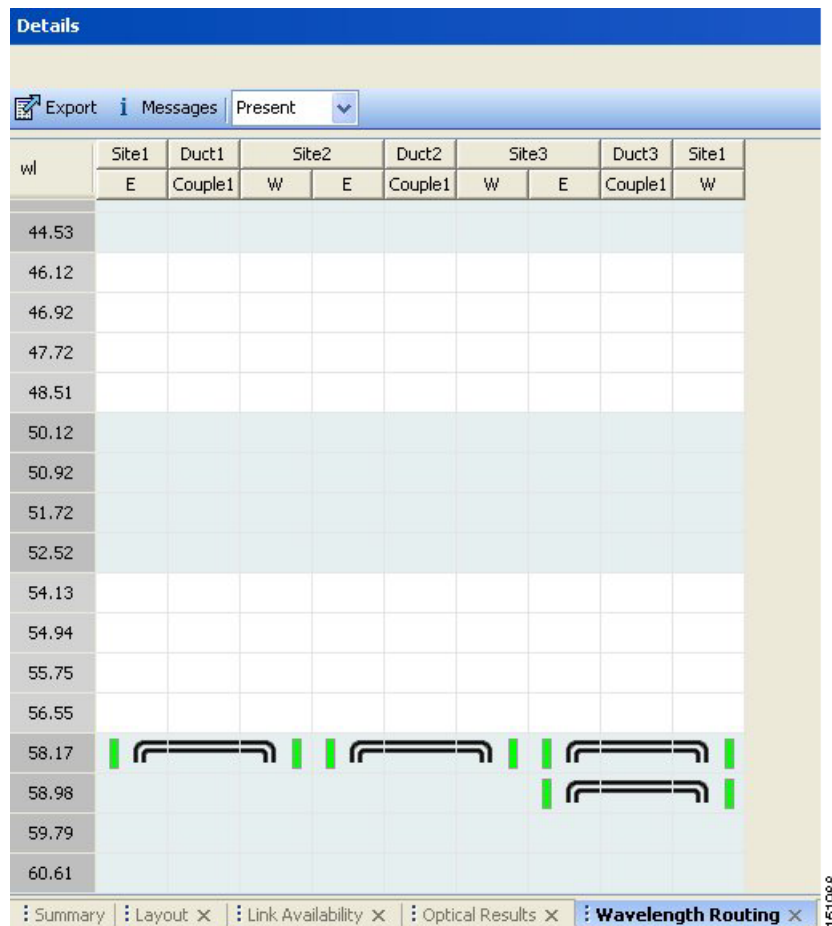

**Step 3** Choose one of the following from the drop-down list: **Any** (to view both forecast and present routing), **Present** (to view only the present routing), or **Forecast** (to view only the forecast routing). When you select Any, forecast demands are shown with a grey background.

Table 2-20 describes the information in the columns.

**Table 2-20 Wavelength Routing Tab Columns**

| Column Label               | Description                                                                                                                                                                                                                                                                                                                                                       |
|----------------------------|-------------------------------------------------------------------------------------------------------------------------------------------------------------------------------------------------------------------------------------------------------------------------------------------------------------------------------------------------------------------|
| wl                         | Lists the wavelengths supported by the platform.                                                                                                                                                                                                                                                                                                                  |
| Site #                     | Represents a site in the network. The colors in the Site columns indicate for each side of the site the SOL/EOL channel status. Green indicates success, yellow indicates success with a marginal failure risk (between 0 and 16 percent), orange indicates that the channel has a higher risk of failure (between 16 and 50 percent), and red indicates failure. |
| Duct #                     | Represents a duct in the network.                                                                                                                                                                                                                                                                                                                                 |
| A                          | Represents a Terminal or a Terminal+ site.                                                                                                                                                                                                                                                                                                                        |
| A and B                    | Represents a Line or Line+ site.                                                                                                                                                                                                                                                                                                                                  |
| A, B, C, and D             | Represents a Multi-Degree site with PP-MESH-4.                                                                                                                                                                                                                                                                                                                    |
| A, B, C, D, E, F, G, and H | Represents a Multi-Degree site with PP-MESH-8.                                                                                                                                                                                                                                                                                                                    |
| Couple                     | Represents a pair of fibers at a site.                                                                                                                                                                                                                                                                                                                            |



**Note** Tool tips are available on this report. Move the cursor over a Site column for circuit information, card name, and product ID. Move the cursor over a Duct/Couple column for loss, length, and fiber type.

**Step 4** To export the graphical representation of the layout in JPEG format, click **Export**. In the Wavelength Routing export dialog box, type the name of the file and navigate to the desired folder. Click **Save**.

**Step 5** To close the Wavelength Routing report, click the **X** in the upper right corner of the window.

## 2.5.11 Viewing Report Differences

You can compare the BoM, Internal Connections, and Installation Parameters reports for two networks. This is useful to see the differences between a baseline network and an Install or Upgrade network.

- The BoM Diff report lists the units that were added and/or removed from the BoM.
- The Internal Connection Diff report lists changed connections. If at least one of the two endpoints of an internal connection is different, Cisco TransportPlanner reports that the internal connection has changed. The report shows all internal connections that were present in the baseline network but are not present in the final network, and all internal connections not present in the baseline network but present in the final network.
- The Installation Parameters Diff report lists changed parameters between the baseline network and the final network.

Use the following procedure to compare networks:

- Step 1** Click the Reports Diff icon. For more information about Cisco TransportPlanner icons, see [Appendix A, “GUI Information and Shortcuts.”](#) The Reports Diff dialog box appears. [Figure 2-46](#) shows the Reports Diff dialog box as it appears when at least two analyzed networks exist in a project.

**Figure 2-46** Reports Diff Dialog Box

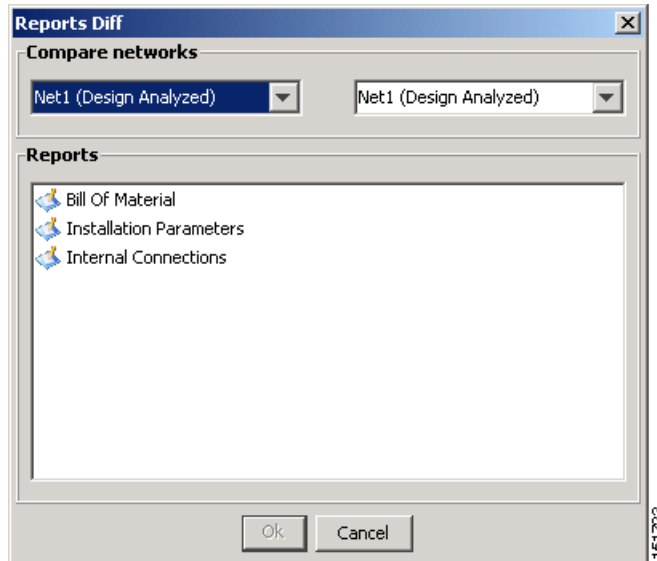

- Step 2** In the Compare networks area, choose the baseline network from the drop-down list on the left. Choose the network to compare from the drop-down list on the right.
- Step 3** Click the report you would like to view. If you chose one non-analyzed network, you can view only the Bill of Material differences report.
- Bill of Material—([Figure 2-47 on page 2-86](#)) For a description of the columns, see [Table 2-21 on page 2-86](#).
  - Installation Parameters—([Figure 2-48 on page 2-87](#)) For a description of the columns, see [Table 2-22 on page 2-88](#).
  - Internal Connections—([Figure 2-49 on page 2-89](#)) For a description of the columns, see [Table 2-23 on page 2-90](#).
- Step 4** Click **OK**.
- [Figure 2-47](#) shows the BoM Diff report.

Figure 2-47 BoM Diff Report

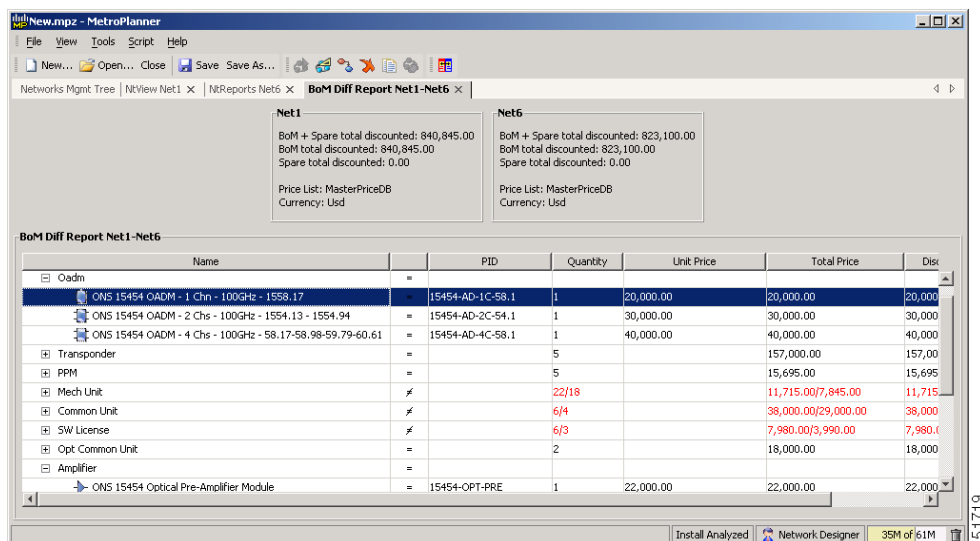

The upper section of the BoM Diff Report tab displays the following information for each network:

- **BoM total discounted**—Displays the price for the overall network (without spare parts) for each item in the BoM. If Use global discount is checked, the total includes the discount from the Global discount percentage field.
- **Spare total discounted**—Displays the price for all of the recommended spare parts in all of the maintenance centers for the overall network. It is the sum of each spare item using the discounted price. The total appears after you check the Spare Part Report check box.
- **BoM + Spare total discounted**—Displays the sum of the BoM total discounted price and spare total discounted price.
- **Price List**—Displays the name of the price list database selected for the project.
- **Currency**—Displays the value of the currency used for each of the price values as specified within the selected price list database.

Table 2-21 describes the information in the BoM Diff report columns. Click a column to sort the table information by that column.

Table 2-21 BoM Diff Report Columns

| Column Label                     | Description                                                                                                                                                                                                                                                                                                                                                                                                                                                                                                                |
|----------------------------------|----------------------------------------------------------------------------------------------------------------------------------------------------------------------------------------------------------------------------------------------------------------------------------------------------------------------------------------------------------------------------------------------------------------------------------------------------------------------------------------------------------------------------|
| Name                             | Displays the name of the site and equipment.                                                                                                                                                                                                                                                                                                                                                                                                                                                                               |
| Difference Summary (not labeled) | Indicates a difference exists between the two network BoMs: <ul style="list-style-type: none"> <li>= (equal sign)—Indicates that no difference exists between the two networks.</li> <li>≠ (not equal sign)—Indicates that the item is present on both networks, but the number per network is different.</li> <li>1—Indicates that this item is present in the first network but not in the second network.</li> <li>2—Indicates that this item is present in the second network but not in the first network.</li> </ul> |



**Table 2-21** BoM Diff Report Columns (continued)

| Column Label           | Description                                                                                                                                                                                                                                                                         |
|------------------------|-------------------------------------------------------------------------------------------------------------------------------------------------------------------------------------------------------------------------------------------------------------------------------------|
| PID                    | Displays the ID string of the product. To view a PID, click on the plus (+) sign by the equipment name to expand it.                                                                                                                                                                |
| Quantity               | Displays the number of specific products in the BoM. If the networks have a different quantity, Cisco TransportPlanner displays both numbers in red in the following format:<br><i>first-network-quantity/second-network-quantity.</i>                                              |
| Unit Price             | Displays the price for each unit. To view a unit price, click on the plus (+) sign by the equipment name to expand it.                                                                                                                                                              |
| Total Price            | Displays the total price of the products before applying the discount. If the networks have a different quantity, Cisco TransportPlanner displays both numbers in red in the following format:<br><i>first-network-total price/second-network-total-price.</i>                      |
| Discounted Total Price | Displays the total price of the products after applying the discount. If the networks have a different quantity, Cisco TransportPlanner displays both numbers in red in the following format:<br><i>first-network-discounted-total-price/second-network-discounted-total-price.</i> |

Figure 2-48 shows the Installation Parameters Diff report.

**Figure 2-48** Installation Parameters Diff Report

| Name  | Side | Position | Unit | Port # | Port ID | Port Label | Parameter                              | Value     | Measuremer |
|-------|------|----------|------|--------|---------|------------|----------------------------------------|-----------|------------|
| Site1 | E    |          |      |        |         |            | dwdm:Rx::Power::Add-and-DropInputPo... | -4.8/-6.2 | dBm        |
|       | E    |          |      |        |         |            | dwdm:Rx::Power::DropPowerBand          | -3.0      | dBm        |
|       | E    |          |      |        |         |            | dwdm:Tx::Power::Add-and-DropOutputP... | -6.1/-5.8 | dBm        |
|       | E    |          |      |        |         |            | dwdm:Tx::Threshold:FiberStageInput     | -3.0      | dBm        |
|       | W    |          |      |        |         |            | dwdm:Rx::Power::Add-and-DropInputPo... | -4.8/-6.2 | dBm        |
|       | W    |          |      |        |         |            | dwdm:Rx::Power::DropPowerBand          | -3.0      | dBm        |
| Site2 | W    |          |      |        |         |            | dwdm:Tx::Power::Add-and-DropOutputP... | -6.1/-5.8 | dBm        |
|       | W    |          |      |        |         |            | dwdm:Tx::Threshold:FiberStageInput     | -3.0      | dBm        |
|       | E    |          |      |        |         |            | dwdm:Rx::Power::Add-and-DropInputPo... | -4.8/-6.2 | dBm        |
|       | E    |          |      |        |         |            | dwdm:Rx::Power::DropPowerBand          | -3.0      | dBm        |
|       | E    |          |      |        |         |            | dwdm:Tx::Power::Add-and-DropOutputP... | -6.1/-5.8 | dBm        |
|       | E    |          |      |        |         |            | dwdm:Tx::Threshold:FiberStageInput     | -3.0      | dBm        |

Table 2-22 describes the columns in the Installation Parameters Diff report. Click a column to sort the table information by that column.

Differences between networks appear in red and in the following format:  
*baseline-network-value/final-network-value.*

**Table 2-22 Installation Parameters Diff Report Columns**

| Category              | Description                                                                                                                                                                                                                                                                                                                                                                                                                                                       |
|-----------------------|-------------------------------------------------------------------------------------------------------------------------------------------------------------------------------------------------------------------------------------------------------------------------------------------------------------------------------------------------------------------------------------------------------------------------------------------------------------------|
| Name                  | Displays the name of the site.                                                                                                                                                                                                                                                                                                                                                                                                                                    |
| <i>(Diff Summary)</i> | Indicates a difference exists between the two network BoMs:<br>= (equal sign)—Indicates that no difference exists between the two networks.<br>≠ (crossed-out equal sign)—Indicates that the item is present on both networks, but the number per network is different.<br>1—Indicates that this item is present in the first network but not in the second network.<br>2—Indicates that this item is present in the second network but not in the first network. |
| Side                  | Displays the node interface: T (terminal), E (east), or W (west).                                                                                                                                                                                                                                                                                                                                                                                                 |
| Position              | Displays the rack, shelf, and slot position of the card from which the patchcord originates.                                                                                                                                                                                                                                                                                                                                                                      |
| Unit                  | Displays the name of the card.                                                                                                                                                                                                                                                                                                                                                                                                                                    |
| Port #                | Displays the port number from which the patchcord originates.                                                                                                                                                                                                                                                                                                                                                                                                     |
| Port ID               | Displays the port ID.                                                                                                                                                                                                                                                                                                                                                                                                                                             |
| Port Label            | Displays the name of the port.                                                                                                                                                                                                                                                                                                                                                                                                                                    |
| Parameter             | Displays the name of the parameter to be set, such as RX Power Low.                                                                                                                                                                                                                                                                                                                                                                                               |
| Value                 | Displays the name of the value to be set.                                                                                                                                                                                                                                                                                                                                                                                                                         |
| Measurement Unit      | Displays the measurement unit for the related installation parameter value, such as dBm.                                                                                                                                                                                                                                                                                                                                                                          |
| Manual Set            | Indicates with a Yes or No which parameters must be manually set using the CTC interface.                                                                                                                                                                                                                                                                                                                                                                         |

Figure 2-37 shows the Internal Connections Diff report.

Figure 2-49 Internal Connections Diff Report

| Name  | Position                   | Unit                 | Port label   | Attenuator | Position                   | Unit                 | Port label   | P/F     |
|-------|----------------------------|----------------------|--------------|------------|----------------------------|----------------------|--------------|---------|
| Cable | Rack 0. 0. Slot 0          | AD-2C-54.1 / AD-1... | port Label ? | ...        | Rack 0. 0. Slot 0          | AD-1C-58.1 / AD-2... | port Label ? | P/F /.. |
| Cable | Rack 1.ShelfAnsi 1.Slot 1  | OSC-CSM              | COM TX       |            | Rack 1.ShelfAnsi 1.Slot 2  | OPT-PRE              | COM RX       | P/F     |
| Cable | Rack 1.ShelfAnsi 1.Slot 13 | TXP_MR_2.5G-58.1     | DWDM-TX      |            | Rack 1.ShelfAnsi 1.Slot 3  | AD-4C-58.1           | AD_RX0       | P/F     |
| Cable | Rack 1.ShelfAnsi 1.Slot 14 | MXP_MR_2.5G-58.1     | DWDM-TX      |            | Rack 1.ShelfAnsi 1.Slot 3  | AD-4C-58.1           | AD_RX1       | P/F     |
| Cable | Rack 1.ShelfAnsi 1.Slot 15 | TXP_MR_10E_C         | DWDM-TX      |            | Rack 1.ShelfAnsi 1.Slot 4  | AD-2C-54.1           | AD_RX0       | P/F     |
| Cable | Rack 1.ShelfAnsi 1.Slot 16 | AD-1C-58.1           | AD_TX0       |            | Rack 1.ShelfAnsi 2.Slot 1  | TXP_MR_2.5G-58.1     | DWDM-RX      | P/F     |
| Cable | Rack 1.ShelfAnsi 1.Slot 16 | AD-1C-58.1           | COM TX       |            | Rack 1.ShelfAnsi 1.Slot 17 | OSC-CSM              | COM RX       | P/F     |
| Cable | Rack 1.ShelfAnsi 1.Slot 16 | AD-1C-58.1           | EXP TX       |            | Rack 1.ShelfAnsi 1.Slot 4  | AD-2C-54.1           | EXP RX       | P/F     |
| Cable | Rack 1.ShelfAnsi 1.Slot 17 | OSC-CSM              | COM TX       |            | Rack 1.ShelfAnsi 1.Slot 16 | AD-1C-58.1           | COM RX       | P/F     |
| Cable | Rack 1.ShelfAnsi 1.Slot 2  | OPT-PRE              | COM TX       |            | Rack 1.ShelfAnsi 1.Slot 3  | AD-4C-58.1           | COM RX       | P/F     |
| Cable | Rack 1.ShelfAnsi 1.Slot 2  | OPT-PRE              | DC TX        |            | Rack 1.ShelfAnsi 1.Slot 2  | OPT-PRE              | DC RX        | P/F     |
| Cable | Rack 1.ShelfAnsi 1.Slot 3  | AD-4C-58.1           | AD_TX0       |            | Rack 1.ShelfAnsi 1.Slot 13 | TXP_MR_2.5G-58.1     | DWDM-RX      | P/F     |
| Cable | Rack 1.ShelfAnsi 1.Slot 3  | AD-4C-58.1           | AD_TX1       |            | Rack 1.ShelfAnsi 1.Slot 14 | MXP_MR_2.5G-58.1     | DWDM-RX      | P/F     |
| Cable | Rack 1.ShelfAnsi 1.Slot 3  | AD-4C-58.1           | AD_TX2       |            | Rack 1.ShelfAnsi 1.Slot 5  | TXP_MR_10E_C         | DWDM-RX      | P/F     |
| Cable | Rack 1.ShelfAnsi 1.Slot 3  | AD-4C-58.1           | AD_TX3       |            | Rack 1.ShelfAnsi 2.Slot 2  | TXP_MR_10E_C         | DWDM-RX      | P/F     |
| Cable | Rack 1.ShelfAnsi 1.Slot 3  | AD-4C-58.1           | COM TX       |            | Rack 1.ShelfAnsi 1.Slot 1  | OSC-CSM              | COM RX       | P/F     |
| Cable | Rack 1.ShelfAnsi 1.Slot 3  | AD-4C-58.1           | EXP TX       |            | Rack 1.ShelfAnsi 1.Slot 4  | AD-2C-54.1           | COM RX       | P/F     |
| Cable | Rack 1.ShelfAnsi 1.Slot 4  | AD-2C-54.1           | AD_TX0       |            | Rack 1.ShelfAnsi 1.Slot 15 | TXP_MR_10E_C         | DWDM-RX      | P/F     |
| Cable | Rack 1.ShelfAnsi 1.Slot 4  | AD-2C-54.1           | AD_TX1       |            | Rack 1.ShelfAnsi 2.Slot 3  | TXP_MR_10E_C         | DWDM-RX      | P/F     |

Table 2-23 lists the columns in the Internal Connections Diff report and their descriptions. Click a column to sort the table information by that column.

Differences between networks appear in red and in the following format: *baseline network value/final network value*.

**Table 2-23 Internal Connections Tab Columns**

| Column Name                      | Description                                                                                                                                                                                                                                                                                                                                                                                                                                               |
|----------------------------------|-----------------------------------------------------------------------------------------------------------------------------------------------------------------------------------------------------------------------------------------------------------------------------------------------------------------------------------------------------------------------------------------------------------------------------------------------------------|
| Name                             | Displays the name of the site. On the SW provisioning view subtab, this column indicates whether the connection should be manually set using the CTC interface or removed.                                                                                                                                                                                                                                                                                |
| Difference Summary (not labeled) | Indicates a difference exists between the two network BoMs:<br>= (equal sign)—Indicates that no difference exists between the two networks.<br>≠ (not equal sign)—Indicates that the item is present on both networks, but the number per network is different.<br>1—Indicates that this item is present in the first network but not in the second network.<br>2—Indicates that this item is present in the second network but not in the first network. |
| Position                         | Displays the rack, shelf, and slot position of the card from which the patchcord originates.                                                                                                                                                                                                                                                                                                                                                              |
| Unit                             | Displays the name of the card.                                                                                                                                                                                                                                                                                                                                                                                                                            |
| Port label                       | Displays the name of the port.                                                                                                                                                                                                                                                                                                                                                                                                                            |
| Attenuator                       | When indicated, this is the product ID of the bulk attenuator to be equipped on this connection. It also reports when an internal attenuator must be placed between the DC-TX and DC-RX ports on the preamplifier (when no DCU is equipped).                                                                                                                                                                                                              |
| Position                         | Displays the rack, shelf, and slot position of the card where the patchcord terminates.                                                                                                                                                                                                                                                                                                                                                                   |
| Unit                             | Displays the name of the card.                                                                                                                                                                                                                                                                                                                                                                                                                            |
| Port Label                       | Displays the name of the port.                                                                                                                                                                                                                                                                                                                                                                                                                            |
| P/F                              | Displays whether the connection relates to a present (P/F) or forecast (F) circuit.                                                                                                                                                                                                                                                                                                                                                                       |

## 2.6 Editing a Project

Cisco TransportPlanner allows you to edit the a project either before or after network analysis. Error messages that occur during network analysis often cannot be resolved until you edit one or more network components.

To complete the procedures in this section, you must have a project open and the network(s) loaded. See the [“2.1.1 Opening a Project”](#) section on page 2-15 and the [“2.1.2 Loading and Unloading Networks”](#) section on page 2-15.

## 2.6.1 Editing Project Parameters

Use the following procedure to edit project parameters:

- 
- Step 1** Click **Project** in the Project Explorer.
- Step 2** In the Properties pane, complete the following as needed:
- Customer—Type the name of the customer (128 character maximum) requiring this network design.
  - Created by—Type the user name (128 character maximum).
  - Units—Displays the span measurement unit: Km (kilometers) or Miles.
  - Price List—Choose the price database from the drop-down list.
  - Layout—Displays ANSI (the North American standard) or ETSI (the international standard) to indicate the platform type. ANSI networks will not allow you to define SDH (ETSI) service demands. ETSI networks will not allow you to define SONET (ANSI) service demands.
- 

## 2.6.2 Editing Network Parameters

Use the following procedure to edit network parameters:

- 
- Step 1** Click a network in the Project Explorer or Networks Mgmt Tree.
- Step 2** In the Properties pane, complete the following as needed:
- Name—Type the network name (128 character maximum).
  - Position—Type the object location in pixels.
  - Created by—Type the user name (128 character maximum).
  - Status—Displays the state of the network (Design, Design-Analyzed, Install, etc.).
  - Use MSM Bundles—Check to use the Multishelf Management Integrated Kit bundle when generating the BoM instead of the single items.
  - Use Spare Parts—Check to determine the spare parts required by the network. If the network is in the Upgrade state, the parts required to support the implemented services and the newly added present services are included. To generate a spare parts report, you must associate the sites in a network with a maintenance center before network analysis.
  - Use Global Discount—Check to use the global discount for the entire network. The global discount is applied to all components in the BoM.
  - Global Discount—Enter a new global discount in the form of a percentage.
  - Service Level—Choose the service level (contract) identifier from the drop-down list.
  - Service Length—Choose the maintenance service level length (in years) from the drop-down list.
  - Include SW Licenses—Check to include software licenses in the BoM.
  - Include Paper Documentation—Check to include paper documentation in the BoM.
  - Include CD Documentation—Check to include CD documentation in the BoM.
  - Hide Bom/price discount—Check to hide the global discount in the Unit Price column of the BoM.

- Dimension—Type the network size in pixels.
- Background color—Click to choose a color for the network background.
- Background image—Displays the JPEG or GIF filename used as a background, if any. To choose a JPEG or GIF file as a background graphic for the network, click the down arrow and navigate to the desired directory.

## 2.6.3 Editing Site Parameters

Editing the site parameters allows you to make changes to the current site configuration. A site folder in the Project Explorer displays the interface node information. [Figure 2-50](#) shows a site in the Project Explorer before network analysis. [Figure 2-51](#) shows a site in the Project Explorer after network analysis.

**Figure 2-50** Site in the Project Explorer

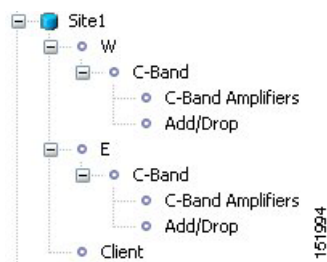
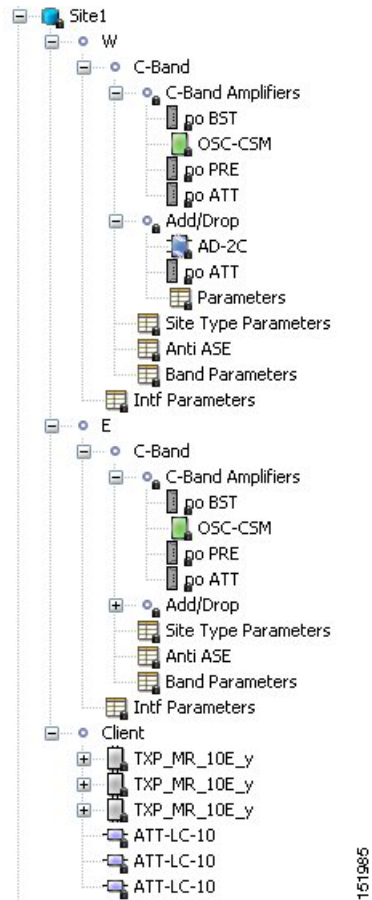

Figure 2-51 Analyzed Site in the Project Explorer



A site folder for an analyzed network design also contains the following items, many of which you can edit:

- E, W, T—For a Line or Line+ site, two interface nodes appear in the Project Explorer under the Site folder, labeled W (West) and E (East). For a Terminal or Terminal+ site, only one interface node (T) appears.
- C-Band or L-Band—Displays the supported band for the side (E, W, or T interface).
- Amplifiers—Lists the amplifiers and all related cards for each band and for each side (E, W, or T interface).
- Add/Drop—Displays all of the add/drop and related cards for the band and side (E, W, or T interface).
- Site Type Parameters—When selected, shows the site functionality and type in the Properties pane.
- Band Parameters—When selected, shows the output power in the Properties pane.
- Client—Lists the client cards.

Use the following procedure to edit site parameters. To delete a site, see the [“2.6.14 Deleting Sites” section on page 2-113](#).

- 
- Step 1** In the Project Explorer, right-click the network folder and choose **Expand** from the shortcut menu.
- Step 2** Click the desired Site folder. The site parameters appear in the Properties pane.

**Step 3** Complete the following to modify the site parameters in the Properties pane, as needed:

- Name—Enter the desired site name.
- Position—Enter the desired site pixel position; for example, an entry of 0,0 positions the Site icon in the upper left corner of the NtView *Name* tab.
- Structure—Choose the structure type from the drop-down list:
  - Line—Two pairs of fibers are terminated at the node.
  - Terminal—A single pair of fibers is terminated at the node.
  - Line+—Two pairs of fibers are terminated at the node but the number of fibers can be increased when an MMU card (topology upgrade) is installed. This node is ready to scale to become a multi-degree node once MMUs are installed in this node.
  - Terminal+—A single pair of fibers is terminated at the node but the number of fibers can be increased in if an MMU card (topology upgrade) is installed. This node is ready to scale to become a multi-degree node once MMUs are installed in this node.
  - Multi-degree—Nodes have more than two sides and faces more than two fibre spans.

The following structure edits are allowed:

- Line to Line+
- Line+ to Line
- Terminal to Terminal+
- Terminal+ to Terminal

To make any other structure change (such as changing from Line to Terminal), you must delete and reinsert the site.

- MTTR (hours)—Enter the mean time to repair (MTTR) for all sites in the network. This will apply to every site in the network. If you change the MTTR value after creating sites, the new value will only apply to sites you create after the change.
- Maintenance Center—Choose the name of the maintenance center from the drop-down list. To create a maintenance center, see the [“2.6.5 Creating a Maintenance Center”](#) section on page 2-99.
- IP Address—Type the IP address of the node.
- Shelf Config—Choose the shelf configuration type from the drop-down list:
  - Multi Shelf Integrated Switch—All the MSTP optical cards (OADMs and amplifiers) reside in different shelves connected by a LAN. The LAN is implemented with switches connected to the MSTP shelves. For this option, Multi-Shelf Integrated Switch Cards (MS-ISC) are used to support the multishelf configuration.
  - Multi Shelf External Switch—All the MSTP optical card (OADMs and amplifiers) reside in different shelves connected by a LAN. The LAN is implemented with switches external to the MSTP shelves. For this option, two external Ethernet switch units are used to support the multishelf configuration.
  - Individual Shelf—All the MSTP optical cards (OADMs and amplifiers) reside in the same shelf. For this option, multishelf management is not supported; every shelf is managed as an independent shelf.
- Node Protection—Choose the node protection type from the drop-down list: Same Shelf or Separated Shelves.
- DCC Shelves Management—When checked, indicates that a TXP(P)\_MR\_2.5G card is in Slot 12 on each shelf at each site.



- TXP/MXP OSMINE placement—When checked, indicates that the transponder/muxponder cards are placed in the shelves according to OSMINE placement rules.
- Hybrid MSTP/MSPP Node—When checked, indicates that all the nodes are configured as hybrid MSTP/MSPP nodes.
- Max Number of Shelves/Bay—Choose the maximum number (from 1 to 4) of ANSI or ETSI shelves (that equip optical cards or transponder/muxponder cards) that can be placed in each rack in the site when generating the site layout.
- Functionality—Choose the site functionality from the drop-down list. [Table 2-24](#) summarizes the site design rules. The site icon changes depending on the functionality. For a description of the site icons, see [Appendix A, “GUI Information and Shortcuts.”](#)
  - Auto—Allows the highest degree of flexibility in creating the network. Cisco TransportPlanner generates a design for the site with the lowest possible cost given the other constraints.
  - Pass Through—Indicates that no equipment will be located at this site.
  - Line amplifier—Prevents any add/drop traffic at this site.
  - OSC site—Indicates that site is designated for network communication, providing the possibility to access the OSC for management of the MSTP network. By default, no amplifiers are included in this site. However, if Cisco TransportPlanner determines that an amplifier is required in the network, it can automatically place it at this location. Cisco TransportPlanner allows you to set (force) preamplifier and booster amplifiers for each direction on a OSC site node.
  - Add/Drop—Indicates that this site has add/drop capability. Only point-to-point and P-ring circuits can be added/dropped at this site.
  - Hub—Indicates that this site is equipped with filters for adding and dropping all the channels (on both West and East sides). All express paths are open in hub configurations.
  - Gain equalizer—Indicates that this site uses WSS cards to control the generated tilt and extend unregenerated distances. The site is realized as an ROADM site without demultiplexer cards.
  - R-OADM—Indicates that this site supports Any-to-Any and also Fixed (point-to-point and P-ring) traffic types.
  - OXC—Indicates that this site uses OXC (optical cross connect) cards to control the generated tilt and extend unregenerated distances. This site is realized as an ROADM site without demultiplexer cards.
  - OIC—Indicates that this site uses OIC (optical inter connect) cards to control the generated tilt and extend unregenerated distances. This site is realized as an ROADM site without demultiplexer cards.



---

**Note** This functionality is available only for multi-degree sites. Also, if you choose the structure of a site as multi-degree and functionality as OXC, the Shelf Management option that you select should either be Integrated or External. Otherwise, the application displays an error message when analyzed.

---

- Type—Choose the site type from the drop-down list (see [Table 2-24](#)):
  - Auto—Allows the highest degree of flexibility in creating the network. Cisco TransportPlanner generates a design for the site with the lowest possible cost given the other set of constraints.
  - Glass Through—Indicates a low-priority amplification site.
  - Line—Indicates a high-priority amplification site.

- OADM—Indicates that it is a site with add/drop channels using discrete channel filters (1, 2, 4-ch 1, 4-band).
- 32-WSS—Indicates that it is a site equipped with 32DMX or 32DMX-O. This option allows you to force the use of specific ROADM units.



**Note** 32-WSS is available as choice in system release 7.0.x and above.

- Mux/Demux—Indicates that this is a full multiplexer/demultiplexer (FMD) site that adds and drops all channels on both sides using the 32MUX-O and 32DMX-O cards. Optical bypass is allowed.
- 40-WXC w/PP-MESH-4—(Multi-degree OXC sites only) Indicates the mesh type that is provided for sites equipped with 40-WXC cards. If this type is selected, the site will be equipped to support up to 4 degrees independently of the number of fibers connected to the site.
- 40-WXC w/PP-MESH-8—(Multi-degree OXC sites only) Indicates the mesh type that is provided for sites equipping 40-WXC cards units. If this type is selected, the site will be equipped support up to 8 degrees independently of the number of fibers connected to the site.
- WSS/DMX—Multi-degree OIC sites only.
- Anti ASE—Choose **Yes** to configure the site so that all the express channels on the site are optically dropped and reinserted. In addition, all the patch cords between the West and East sections are removed. Choose **Auto** to allow Cisco TransportPlanner to decide if the site should be configured as anti-amplified spontaneous emissions (anti-ASE). See [Table 2-24](#) for a summary of the site design rules.

**Table 2-24 Site Design Rules**

| Structure | Functionality  | Type               | Card Options | C-Band<br>32/16 Ch.<br>100 GHz | C-Band<br>8 Ch.<br>100 GHz | C-Band<br>64 Ch.<br>50 GHz | L-Band<br>32 Ch.<br>100 GHz |
|-----------|----------------|--------------------|--------------|--------------------------------|----------------------------|----------------------------|-----------------------------|
| Line      | Pass Through   | —                  | —            | Yes                            | Yes                        | Yes                        | Yes                         |
|           | Line amplifier | Line amplifier     | —            | Yes                            | Yes                        | Yes                        | Yes                         |
|           |                | Glass Through      | —            | Yes                            | Yes                        | Yes                        | Yes                         |
|           | OSC Site       | —                  | —            | Yes                            | Yes                        | Yes                        | Yes                         |
|           | Add/Drop       | OADM<br>(Anti-ASE) | OADM cards   | Yes                            | Yes                        | No                         | No                          |
|           |                | Mux/Demux          | —            | Yes                            | Yes                        | No                         | No                          |
|           | Hub            | Mux/Demux          | —            | Yes                            | Yes                        | No                         | No                          |
|           |                | WSS                | 32DMX-O      | Yes                            | Yes                        | Yes                        | No                          |
|           |                |                    | 32DMX        | Yes                            | Yes                        | Yes                        | Yes                         |
|           | Gain equalizer | WSS                | 32DMX        | Yes                            | No                         | Yes                        | Yes                         |
| ROADM     | WSS            | 32DMX-O            | Yes          | No                             | Yes                        | No                         |                             |
|           |                | 32DMX              | Yes          | No                             | Yes                        | Yes                        |                             |

Table 2-24 Site Design Rules (continued)

| Structure    | Functionality | Type               | Card Options                    | C-Band<br>32/16 Ch.<br>100 GHz | C-Band<br>8 Ch.<br>100 GHz | C-Band<br>64 Ch.<br>50 GHz | L-Band<br>32 Ch.<br>100 GHz |
|--------------|---------------|--------------------|---------------------------------|--------------------------------|----------------------------|----------------------------|-----------------------------|
| Line+        | ROADM         | WSS                | 32DMX-O                         | Yes                            | No                         | No                         | No                          |
|              |               |                    | 32DMX                           | Yes                            | No                         | No                         | Yes                         |
|              | Hub           | WSS                | 32DMX-O                         | Yes                            | No                         | No                         | No                          |
|              |               |                    | 32DMX                           | Yes                            | No                         | No                         | Yes                         |
| Terminal     | Add/Drop      | OADM<br>(Anti-ASE) | OADM cards                      | Yes                            | Yes                        | No                         | No                          |
|              |               | Mux/Demux          | —                               | Yes                            | Yes                        | No                         | No                          |
|              | ROADM         | WSS                | 32DMX-O                         | Yes                            | Yes                        | Yes                        | No                          |
|              |               |                    | 32DMX                           | Yes                            | Yes                        | Yes                        | Yes                         |
| Terminal+    | ROADM         | WSS                | 32DMX-O                         | Yes                            | No                         | No                         | No                          |
|              |               |                    | 32DMX                           | Yes                            | No                         | No                         | Yes                         |
| Multi-Degree | OXC           | PP MESH-4          | Add: 32-WSS<br>Drop: 32-DMX     | Yes                            | No                         | No                         | No                          |
|              |               |                    | Add: 40-MUX-C<br>Drop: 40-MUX-C | Yes                            | No                         | No                         | No                          |
|              |               |                    | Add: 40-WSS-C<br>Drop: 40-DMX-C | Yes                            | No                         | No                         | No                          |
|              |               | PP MESH-8          | Add: 32-WSS<br>Drop: 32-DMX     | Yes                            | No                         | No                         | No                          |
|              |               |                    | Add: 40-MUX-C<br>Drop: 40-MUX-C | Yes                            | No                         | No                         | No                          |
|              |               |                    | Add: 40-WSS-C<br>Drop: 40-DMX-C | Yes                            | No                         | No                         | No                          |
|              | OIC           | —                  | Add: 32-WSS<br>Drop: 32-DMX     | Yes                            | No                         | Yes                        | No                          |
|              |               |                    | Add: 40-WSS-C<br>Drop: 40-DMX-C | Yes                            | No                         | Yes                        | No                          |
|              |               | —                  | Add: 32-WSS<br>Drop: 32-DMX     | Yes                            | No                         | Yes                        | No                          |
|              |               |                    | Add: 40-WSS-C<br>Drop: 40-DMX-C | Yes                            | No                         | Yes                        | No                          |

**Step 4** To modify the band parameters, click **C-Band** or **L-Band** in the Project Explorer for the desired site interface. In the Properties pane, enter the desired Output power.

**Step 5** To modify amplifier parameters, click **C-Band Amplifiers** or **L-Band Amplifiers** in the Project Explorer for the desired site interface. Choosing a value other than Auto will force a setting on the unit. For more information, see the “1.6 Auto, Forced, and Locked Parameters” section on page 1-11.

a. In the Properties pane From Fibre area, complete the following as needed:

- PRE—Choose the desired preamplifier from the drop-down list (**None**, **Auto**, **OPT-PRE** [C-band], **OPT-AMP-C** [C-band], or **OPT-AMP-L** [L-band]).

- DCU 1/2—Choose the desired DCU from the drop-down lists.
  - Attenuator—Choose the desired attenuator from the drop-down list.
  - Output power—Enter the desired output power.
  - Tilt—Enter the desired tilt value.
  - Attenuator—Choose the attenuator from the drop-down list.
- b. In the Properties pane To Fibre area, complete the following as needed:
- BST—Choose the desired booster from the drop-down list (**None**, **Auto**, **OPT-BST** [C-band], **OPT-BST-E** [C-band], **OPT-AMP-L** [L-band], or **OPT-BST-L** [L-band]).
  - DCU 1/2—Choose the desired DCU from the drop-down lists.
  - Output power—Enter the desired output power.
  - Tilt—Enter the desired tilt value.
- c. In the Properties pane General area, choose the OSC from the drop-down list (**OSC-CSM** or **OSCM**).
- Step 6** To modify OADM parameters, click **Add/Drop** in the Project Explorer for the desired site interface. In the Properties pane, complete the following as needed:
- In the Line/OADM area, choose the desired attenuator from the drop-down list.
  - In the Mux/Demux WSS area, complete the following as needed:
    - Patch Panel—Choose the patch panel from the drop-down list.
    - Demux—Choose the demultiplexer from the drop-down list (**Auto**, **32DMX-O**, or **32-DMX**).

## 2.6.4 Editing Service Demand Association and Traffic Subnet

Use this procedure to change the association of a service demand from one traffic subnet to another. You can change the association if the destination subnetwork satisfies all of the add/drop requirements of the service demand.

You can edit a traffic subnet only in the Design mode; in Install and Upgrade mode, this feature is not supported.

- Step 1** In the Project Explorer Pane, right-click **Traffic Subnets** and choose **View Demand Relationship** from the shortcut menu. The Select Subnet dialog box appears (see [Figure 2-52](#)).
- Step 2** Expand the Traffic Subnet folder to view the service demands associated with it.
- Step 3** Click the **Move to Subnet** row to see the list of destination traffic subnets where this service demand can be moved to. The list will only contain those Traffic Subnets that can satisfy the add/drop needs of this service demand.



### Note

Cisco TransportPlanner will check to see if each user-forced demand can be met at the destination traffic subnet. In case the check fails, a message shall be displayed asking the user to confirm if this operation should be continued. Click Yes to continue. All the unfeasible properties within each demands will be reset to the default value.

- Step 4** Select the desired destination traffic subnet and click **Ok**.

- Step 5** To edit a defined traffic subnet, right-click **Traffic Subnets** in the Project Explorer pane and choose **Edit**. The Traffic Subnet Builder dialog box shown in [Figure 2-52](#) appears.
- Step 6** From the Selected Ducts area, click the ducts you want to include the new the new traffic subnet and click **OK**. The selected ducts are added in the Choose Ducts area.
- Step 7** Click **OK**. The properties of the original traffic subnet are updated with the selected options.



**Note** Later, when analyzing the network, if the tool discovers that the order of the add/drop sites in the destination traffic subnet has been modified, the analyzer will mark these traffic demands as invalid and will not proceed with the analysis.

**Figure 2-52** Select Subnet Dialog Box

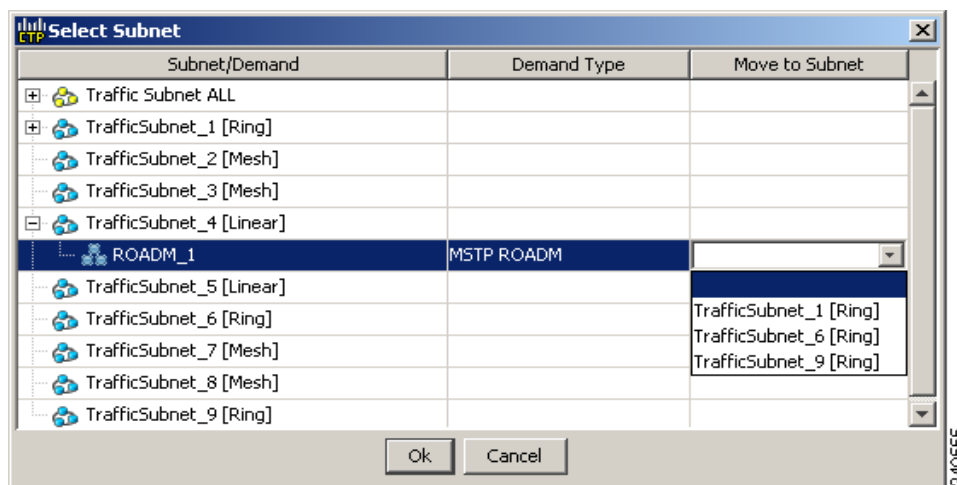

## 2.6.5 Creating a Maintenance Center

Use the following procedure to add maintenance centers that will supply your network with spare parts in the event of a failure. This feature helps your customer determine the quantity of spares that should be purchased, depending on the number of maintenance centers and their availability. Maintenance centers appear in the Maintenance Center folder under a site in the Project Explorer.

- Step 1** In the Project Explorer, right-click the network folder and choose **Expand** from the shortcut menu.
- Step 2** Scroll down the Project Explorer, right-click the **Maintenance Center** folder, and choose **New Maintenance Center** from the shortcut menu.
- Step 3** Highlight the new maintenance center in the Project Explorer.
- Step 4** In the Properties pane, complete the following as needed:
- Confidence Level—Choose the percentage that represents the required confidence level for finding needed spare parts in the maintenance center: **50**, **75**, **95**, or **99** percent.
  - Restocking time (days)—Enter the time (including transportation) required to restock the part in the maintenance center.

- Step 5** To associate a maintenance center with a site, see the “2.6.3 Editing Site Parameters” section on page 2-92.

## 2.6.6 Editing a Point-to-Point Demand

Use the following procedure to edit a point-to-point demand:

- Step 1** In the Project Explorer, right-click the network folder and choose **Expand** from the shortcut menu.
- Step 2** In the Project Explorer, right-click the point-to-point demand and choose **Edit** from the shortcut menu. The Edit Point to Point Demand dialog box appears (Figure 2-53).

**Figure 2-53** Edit Point to Point Demand Dialog Box

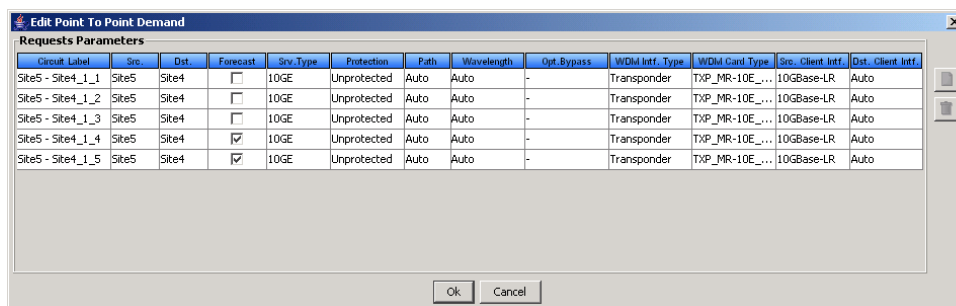

- Step 3** To modify the information for each channel, complete the following as needed:
- **Forecast**—Check to change a present channel to a forecast channels.
  - **Srv. Type**—Choose the desired service type from the drop-down list. Changing the service type for one channel automatically changes the service type for all channels.
  - **Protection**—Choose the desired protection type from the drop-down list. Changing the protection type for one channel automatically changes the protection type for all channels.
  - **Path**—Choose **W** (west-to-east) or **E** (east-to-west) from the drop-down list.
  - **Wavelength**—Choose the desired wavelength type from the drop-down list. If you choose Auto, Cisco TransportPlanner assigns wavelength to the channels with the lowest possible cost given the other constraints.
  - **Optical Bypass**—Choose the site for optical bypass from the drop-down list.
  - **WDM Intf. Type**—Choose the desired card interface type from the drop-down list.
  - **WDM Card Type**—Choose the desired card type from the drop-down list. The available options depend on the card interface type that is selected. Changing the card type for one channel automatically changes the card type for all channels.
  - **Src. Client Intf.**—Choose the desired source client interface from the drop-down list. The available options depend on the card type that is selected.
  - **Dst. Client Intf.**—Choose the desired destination client interface from the drop-down list. The available options depend on the card type that is selected.
- Step 4** To add a new channel, click the Create a new circuit icon on the right of the Edit Point to Point Demand dialog box. A new row appears. Repeat **Step 3** as needed to complete the parameters for the new channel.

- Step 5** To delete an existing channel, select the row and click the Remove the selected circuit icon on the right of the Edit Point to Point Demand dialog box.
- Step 6** Click **Ok** to save the changes to the channels and close the Edit Point to Point Demand dialog box, or **Cancel** to close the dialog box without saving the changes.

## 2.6.7 Editing a P-Ring Demand

Use the following procedure to change the distribution of services in a P-ring service demand:

- Step 1** In the Project Explorer, right-click the network folder and choose **Expand** from the shortcut menu.
- Step 2** In the Project Explorer, right-click the P-ring demand and choose **Edit** from the shortcut menu. The Edit P-Ring Demand dialog box appears (Figure 2-54).

**Figure 2-54** Edit P-Ring Demand Dialog Box

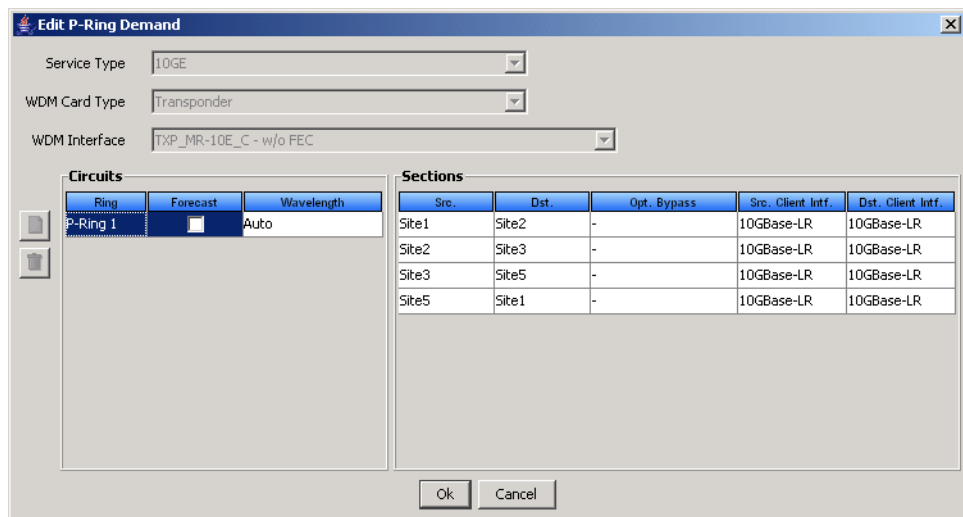

- Step 3** Complete the following as needed in the Edit P-Ring Demand dialog box to modify the P-ring:
- **Service Type**—Choose the desired service type from the drop-down list.
  - **WDM Card Type**—Choose the desired card type from the drop-down list. The available options depend on the service type selected.
  - **WDM Interface**—Choose the desired card interface type from the drop-down list. The available options depend on the card type selected.

In the Circuits area of the Edit P-Ring Demand dialog box, complete the following as needed:

- **Ring**—(Display only) Displays the name of the P-ring.
- **Forecast**—Check to change the present channels to forecast channels.
- **Wavelength**—Choose the desired wavelength type from the drop-down list. If you choose Auto, Cisco TransportPlanner assigns wavelengths to the channels with the lowest possible cost given the other constraints.

In the Sections area of the Edit P-Ring Demand dialog box, complete the following as needed:

- Src—(Display only) Displays the source site name for a section.
  - Dst—(Display only) Displays the destination site name for a section.
  - Opt. Bypass—Choose the sites from the drop-down list where the channels for the current demand will be optically dropped. Only the sites between the source and destination sites along the path of this section are available as options.
  - Src. Client Intf.—Choose the desired source client interface from the drop-down list. The available options depend on the card type selected.
  - Dst. Client Intf.—Choose the desired destination client interface from the drop-down list. The available options depend on the card type selected.
- Step 4** To add a new P-ring channel, click the Create a new P-Ring circuit icon on the left of the Edit Point to Point Demand dialog box. A new row appears. Repeat [Step 3](#) as needed to complete the parameters for the new P-Ring.
- Step 5** To delete an existing channel from the P-ring, select the row and click the Remove the selected P-Ring circuit icon on the left of the Edit P-Ring Demand dialog box.
- Step 6** Click **Ok** to save the changes to the channels and close the Edit P-Ring Demand dialog box, or **Cancel** to close the dialog box without saving the changes.

## 2.6.8 Editing a ROADM Demand

Use the following procedure to change the distribution of services in a ROADM service demand:

- Step 1** In the Project Explorer, right-click the network folder and choose **Expand** from the shortcut menu.
- Step 2** Right-click the ROADM traffic group and choose **Edit** from the shortcut menu. The Edit ROADM Demand dialog box appears ([Figure 2-55](#)).

**Figure 2-55** Edit ROADM Demand Dialog Box

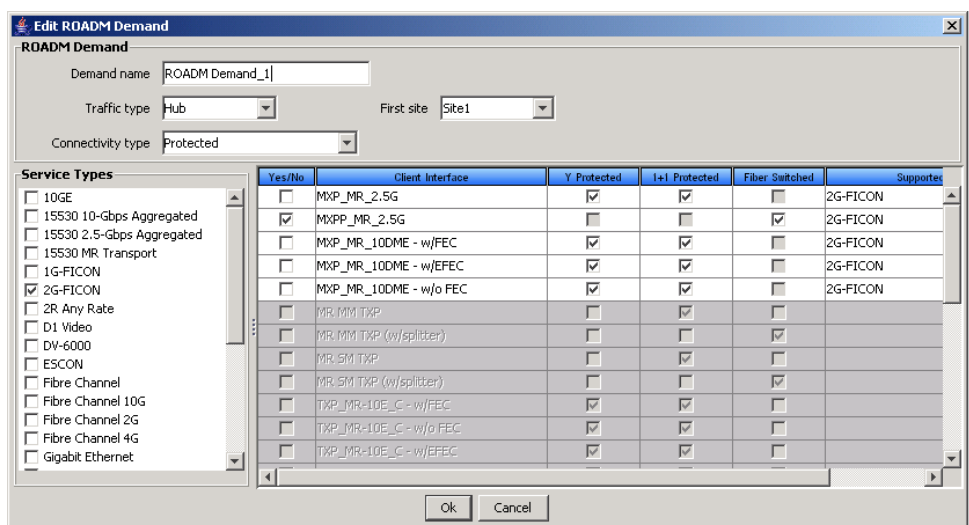

- Step 3** Select a traffic pattern type (**Hub** or **Meshed**) from the drop-down list. If you select Hub, the First Site drop-down button becomes available. If you selected Meshed, go to [Step 5](#).



- Step 4** For Hub traffic types, select the originating site from the First Site drop-down list.
- Step 5** Select a connectivity type from the Connectivity type drop-down list. The choices are **Protected**, **Unprotected Minimum Hop**, **Unprotected Optimum Path**, and **Unprotected Subnet**. Refer to the “[1.5.3 ROADM Traffic Demands](#)” section on page 1-9 for more information about the connectivity type choices.
- Step 6** In the Service types pane, check the boxes for one or more client service types for the ROADM demand. The client interfaces that support each service type appear in the right pane.
- Step 7** To further refine the client interfaces, complete the following options for each row in the right pane. Check boxes in gray are not available for the client interface selection.
- Yes/No—Check to select this card to implement the service type.
  - Client Interface—Displays the card type for the selected service type.
  - Y-Cable—Check to select Y-cable protection if the connectivity type is Protected.
  - 1+1 Protected—Check to select 1+1 protection if the connectivity type is Protected.
  - Fiber Switched—Check to select fiber-switching protection if the connectivity type is Protected.
  - Supported Service—Displays the service types supported for the card.
- You can select more than one client interface to support the same service type. By default, Cisco TransportPlanner checks the best client interface to support each service.
- Step 8** Click **Ok** to save the changes to the demand.
- 

## 2.6.9 Editing an Ethernet Aggregated Demand

Use the following procedure to edit Ethernet aggregated demand.

- Step 1** In the Project Explorer, right-click the network folder and choose **Expand** from the shortcut menu.
- Step 2** In the Project Explorer, right-click the Ethernet aggregated demand and choose **Edit demand** from the shortcut menu. The Ethernet Aggregated Demand dialog box appears ([Figure 2-56](#)).

Figure 2-56 Ethernet Aggregated Demand Dialog Box

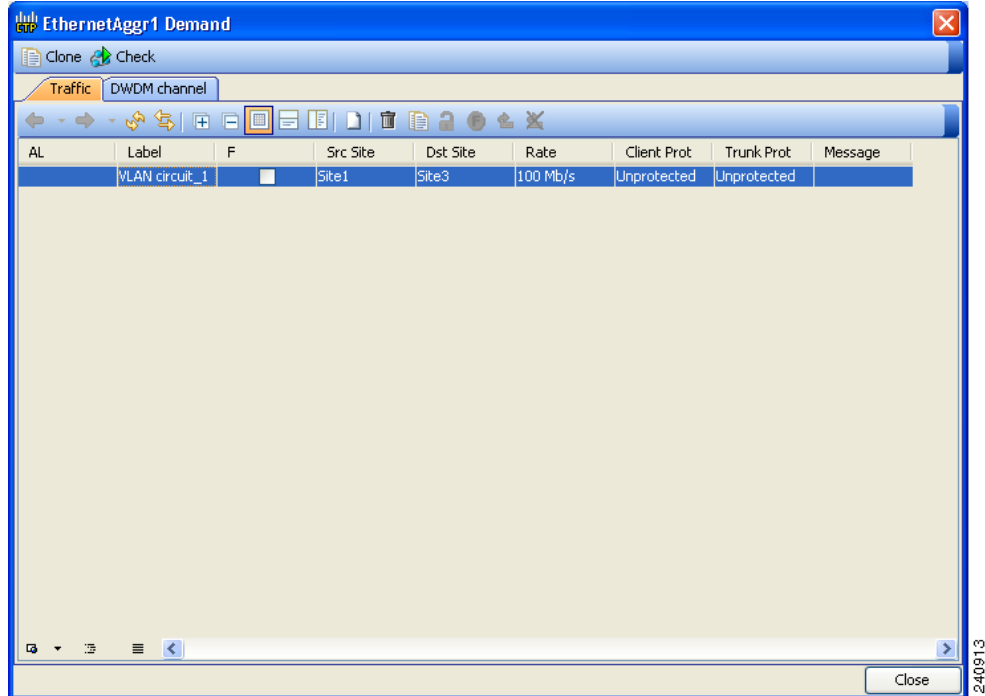

- Step 3** Click **Create a New Circuit** icon on the toolbar to add a new circuit to the existing WDM transport channel. The New Request dialog box appears (see [Figure 2-57](#)).
- Step 4** If a circuit already exists, to make a copy of it, right-click the circuit and click **Copy Circuit**. A new circuit will appear as a WDM traffic channel with the same parameters as the original circuit.
- Step 5** To delete a circuit, right click the circuit and click **Delete Circuit**.

**Figure 2-57** Adding Circuit to a WDM Transport Channel

**New request**

**Point to point request**  
Create a new Ethernet Aggregated Demand request

Quantity: 1

**General**

Label: WLAN circuit\_1 Trunk Protection: Unprotected

P/F: Present Client Protection: Unprotected

Path Forcing: Auto Circuit Rate: 100 Mbit/sec

**Src**

Site: Site1 Port Num: Auto

Port CIR: 1 Port Rate-Reach: Auto

Card: Auto

**Dest**

Site: Site2 Port Num: Auto

Port CIR: 1 Port Rate-Reach: Auto

Card: Auto

OK Cancel

2403664

**Step 6** To modify the parameters of an existing circuit, double click the circuit. The Edit Request dialog box appears (see [Figure 2-58](#)).

**Figure 2-58** Edit Request Dialog Box for an Ethernet WDM Transport Channel

**Edit request**

**General**

Label: WLAN circuit\_1 Trunk Protection: Unprotected

P/F: Present Client Protection: Unprotected

Path Forcing: Auto Circuit Rate: 100 Mbit/sec

**Src**

Site: Site3 Port Num: Auto

Port CIR: 1 Port Rate-Reach: Auto

Card: Auto

**Dest**

Site: Site1 Port Num: Auto

Port CIR: 1 Port Rate-Reach: Auto

Card: Auto

OK Cancel

240572

**Step 7** Change the following as needed in the Edit Request dialog box:

- The label for the circuit

- P/F flag as desired
- Path Forcing—Allows you to force the circuit routing on the traffic subnet associated with this demand. The following values are supported:
  - Auto—This is the default value. When set to this, the tool automatically defines the trunk path.
  - Side <x> where Side <x> —Represents the label of side on the Src Site where the circuit is routed.
- Trunk Protection—Allowed values are Unprotected, UPSR.
- Client Protection—Allowed values are Unprotected, 1+1 APS.
- Circuit rate—Displays the allowed circuit rates.
- Src Site—Allowed values include the list of sites added in the WDM traffic channel. You can set it to Auto for the tool to select an appropriate value.
- Port CIR—This is the committed information rate, with 1 being the max and 0.1 being the lowest.
- Card Type—Allowed values are Auto, 10GE-XP, or GE-XP. Auto allows the tool to select a appropriate card type based on other constraints
- Port Num—Allowed values are Auto, 1, and 2. Auto allows the tool to select an appropriate port number based on other constraints.
- Portp Rate-Reach—Select the desired PPM for this port, or set it to Auto to allow the tool to select an appropriate value.
- Dest Site—Allowed values include the list of sites added in the WDM Traffic channel. You can set it to Auto for the tool to select an appropriate value.
- Card type—Allowed values are Auto, 10GE-XP, or GE-XP. Auto allows the tool to select an appropriate card type based on other constraints.
- Port Num—Allowed values are Auto, 1, and 2. Auto allows the tool to select an appropriate Port number based on other constraints.
- SFP Lambda—Select the desired SFP/XFP for this port or set it to Auto to allow the tool to select an appropriate value.

**Step 8** Click **Ok** to complete and to return to the New Request dialog box.

**Step 9** Enter the number of circuits to be created in Quantity area.

**Step 10** In the General area, enter the following:

- Label—Enter the label for the circuit. By default, VLAN\_Circuit\_x will be used.
- P/F flag—Check this box if this demand will be needed in the future; uncheck this box if this demand is needed now. This parameter will drive the list of pluggable port modules to be equipped on the card and will affect BoM reports.
- Client Protection—Allowed values are Unprotected, 1+1 APS.
- Trunk Protection—Allowed values are Unprotected, UPSR.
- Circuit rate—Displays the allowed circuit rates.
- Path Forcing—This option allows you to force the circuit routing on the traffic subnet associated with this demand. The following values are supported:
  - Auto—This is the default value. When set to this, the tool automatically defines the trunk path.
  - Side <x> where Side <x> —Represents the label of side on the Src Site where the circuit is routed.

**Step 11** In the Src area, complete the following:

- Site—Select the source site. Allowed values include the list of sites added in the WDM traffic channel.
- Card—Select the Card. Allowed values are Auto, 10GE-XP or GE-XP. Auto allows the tool to select an appropriate card type based on other constraints.
- Port Num—Select the port number. Allowed values Auto, 1, and 2. Auto allows the tool to select an appropriate port number based on other constraints.
- Port CIR—Select the CIR, with 1 being the max and 0.1 being the lowest.
- Port Rate-Reach—Select the desired PPM for this port, or set it to Auto to allow the tool to select an appropriate value.

**Step 12** Under Dest area complete the following:

- Dest Site—Select the destination site. Allowed values include the list of sites added in the WDM traffic channel.
- Port Num—Allowed values Auto are 1, and 2. Auto allows the tool to select an appropriate port number based on other constraints.
- Card—Allowed values, Auto, 10GE-XP, or GE-XP. Auto allows the tool to select an appropriate card type based on other constraints.
- Port CIR—This is the committed information rate, with 1 being the max and 0.1 being the lowest.
- Port Rate-Reach—Select the desired SFP/XFP for this port, or set it to Auto to allow the tool to select an appropriate value.

**Step 13** Click **Ok** to complete the creation of the circuit.

**Step 14** Click the **Check** tab on the left corner of the window to generate a report showing the circuit path in the WDM traffic channel and to check any over-allocation of bandwidth (see [Figure 2-59](#)). The report shows, in a row, each of the site on the subnet, and each span in between.

**Figure 2-59** Circuit Path View in a Ethernet Aggregated Demand

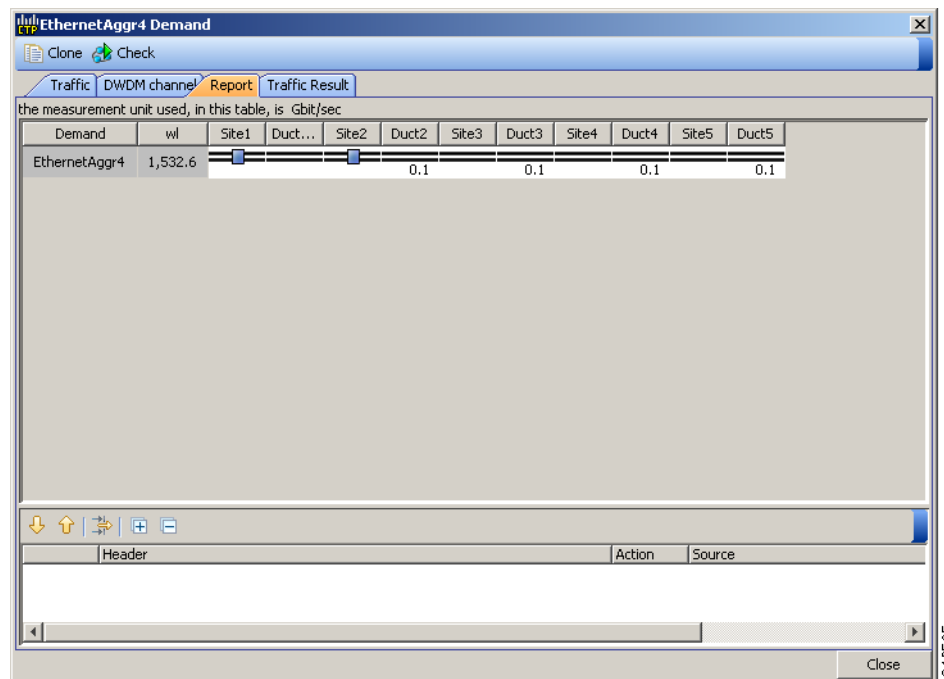

- Step 15** You can add as many circuits as the available bandwidth of the WDM Transport channel allows. When you are finished, click **Close**.

## 2.6.10 Editing a TDM Aggregated Demand

Use the following steps to edit a TDM aggregated demand.

- Step 1** In the Project Explorer, right-click the network folder and choose **Expand** from the shortcut menu.
- Step 2** In the Project Explorer, right-click the TDM aggregated demand and choose **Edit demand** from the shortcut menu. The TDM Aggregated Demand dialog box appears (Figure 2-32).
- Step 3** On the Traffic tab, click the create a new circuit icon. The New Request dialog box appears (see Figure 2-61).
- Step 4** If a circuit already exists, make a copy of it by right-clicking the circuit and clicking **Copy Circuit**. A new circuit will appear under WDM Traffic channel with the same parameters as the original circuit.
- Step 5** To delete a circuit, right-click the circuit and click **Delete Circuit**.
- Step 6** To modify the parameters of an existing circuit, double-click the circuit. The **Edit request** dialog box appears (see Figure 2-60).

**Figure 2-60** Edit Request in a TDM WDM Transport Channel

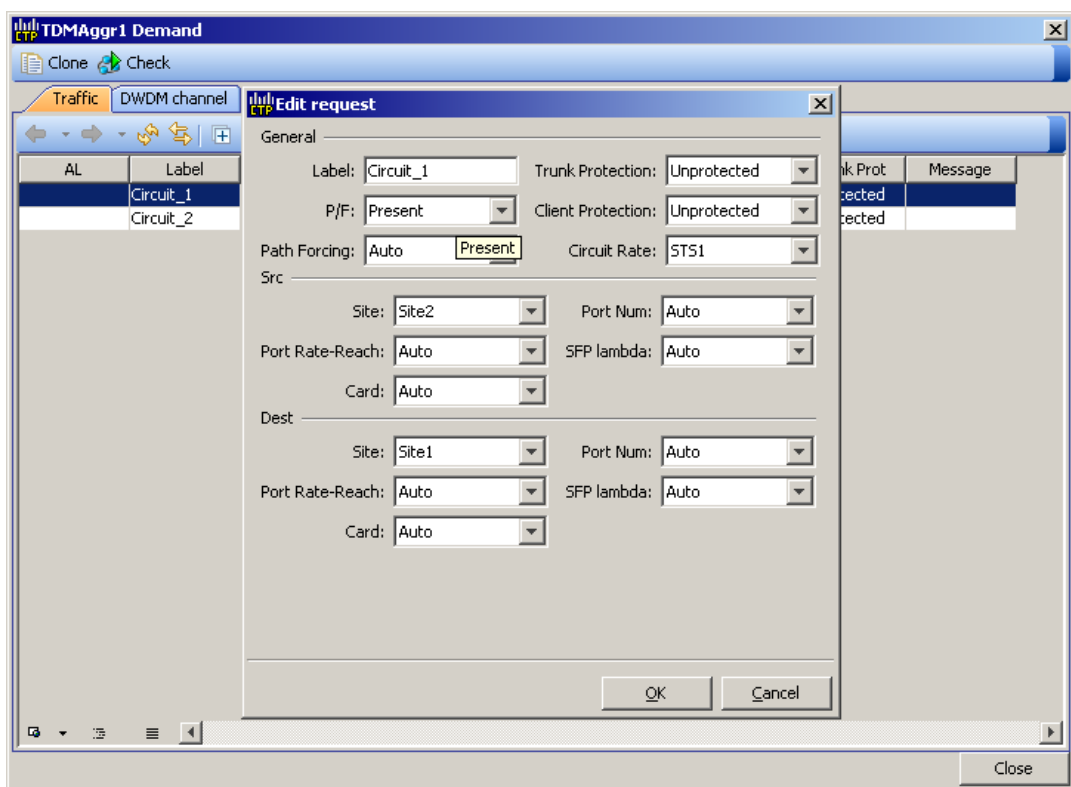

- Step 7** Change the following as needed in the Edit Request dialog box:
- The label for the circuit

- P/F flag as desired
- Path Forcing—This option forces the circuit routing on the traffic subnet associated to the aggregated demand. The following values are supported:
- Trunk Protection—Allowed values are Unprotected, UPSR.
- Client Protection—Allowed values are Unprotected, 1+1 APS.
- Circuit rate—Allowed values are STS1, STS3c, STS6c, STS9c, STS12c, STS18c, STS24c, STS36c, STS48c, and GE-ST24.
  - Auto—This is the default value. When set to this, the tool automatically defines the trunk path.
  - Side <x> —Where Side <x> represents the label of side on the source site where the circuit is routed.
- Site—Allowed values include the list of sites added in the WDM Traffic channel. You can set it to Auto for the tool to select an appropriate value.
- Port Rate-Reach—Select the desired PPM for this port or set it to Auto to allow the tool to select an appropriate value.
- Card—Allowed values are Auto, 10GE-XP, or GE-XP. Auto allows the tool to select an appropriate card type based on other constraints.
- Port Num—Allowed values are Auto, 1, and 2. Auto allows the tool to select an appropriate port number based on other constraints.
- Port CIR—This is the committed information rate, with 1 being the max and 0.1 being the lowest.
- Dest Site—Allowed values include the list of sites added in the WDM traffic channel. You can set it to Auto for the tool to select an appropriate value.
- Port Rate-Reach—Select the desired SFP/XFP for this port or set it to Auto to allow the tool to select an appropriate value.
- Card—Allowed values are Auto and ADM. Auto allows the tool to select an appropriate card type based on other constraints.
- Port Num—Allowed values are Auto, 1, and 2and. Auto allows the tool to select an appropriate port number based on other constraints.

**Step 8** Click **Ok** to complete the creation of the circuit and return to the New request dialog box.

**Step 9** Enter the number of circuits to be created in the Quantity area.

Figure 2-61 TDM Point to point Circuit Creation in a WDM transport channel

**New request**  
**Point to point request**  
 Create a new TDM Aggregated Demand request

Quantity: 1

**General**  
 Label: Circuit\_1 Trunk Protection: Unprotected  
 P/F: Present Client Protection: Unprotected  
 Path Forcing: Auto Circuit Rate: STS1

**Src**  
 Site: Site1 Port Num: Auto  
 Port Rate-Reach: Auto  
 Card: Auto

**Dest**  
 Site: Site3 Port Num: Auto  
 Port Rate-Reach: Auto  
 Card: Auto

OK Cancel

**Step 10** In the General area, complete the following:

- Select the label for the circuit. By default, VLAN\_Circuit1 will be used.
- P/F flag—Check this box if this demand will be needed in the future; uncheck this box if this demand is needed now. This parameter will drive the list of pluggable port modules to be equipped on the card and will affect BoM reports.
- Client Protection—Allowed values are Unprotected and 1+1 APS.
- Trunk Protection—Allowed values are Unprotected and UPSR.
- Circuit rate—Allowed values are STS1, STS3c, STS6c, STS9c, STS12c, STS18c, STS24c, STS36c, STS48c, and GE-STS24.
- Path Forcing—This option forces the circuit routing on the traffic subnet associated to this aggregated demand. The following values are supported:
  - Auto—This is the default value. When set to this, the tool automatically defines the trunk path.
  - Side <x>—Where Side <x> represents the label of side on the source site where the circuit is routed.

**Step 11** In the Src area, complete the following:

- Site—Select the source site. Allowed values include the list of sites added in the WDM traffic channel.
- Port Rate-Reach—Select the desired PPM for this port or set it to Auto to allow the tool to select an appropriate value.
- Card—Select the card. Allowed values are Auto and ADM. Auto allows the tool to select an appropriate card type based on other constraints.



- Port Num—Select the port number. Allowed values are Auto, 1, and 2. Auto allows the tool to select an appropriate port number based on other constraints.
- Step 12** In the Dest area, complete the following:
- Site—Select the destination site. Allowed values include the list of sites added in the WDM traffic channel.
  - Port Rate-Reach—Select the desired PPM for this port or set it to Auto to allow the tool to select an appropriate value.
  - Card type—Allowed values are Auto and ADM. Auto allows the tool to select an appropriate card type based on other constraints.
  - Port Num—Allowed values Auto and 1 through 16. Auto allows the tool to select an appropriate port number based on other constraints.
- Step 13** Click **OK** to complete the creation of Circuit. On the Traffic tab, you can see the created circuit (Figure 2-62).

**Figure 2-62 TDM Circuit in a TDM Aggr Demand**

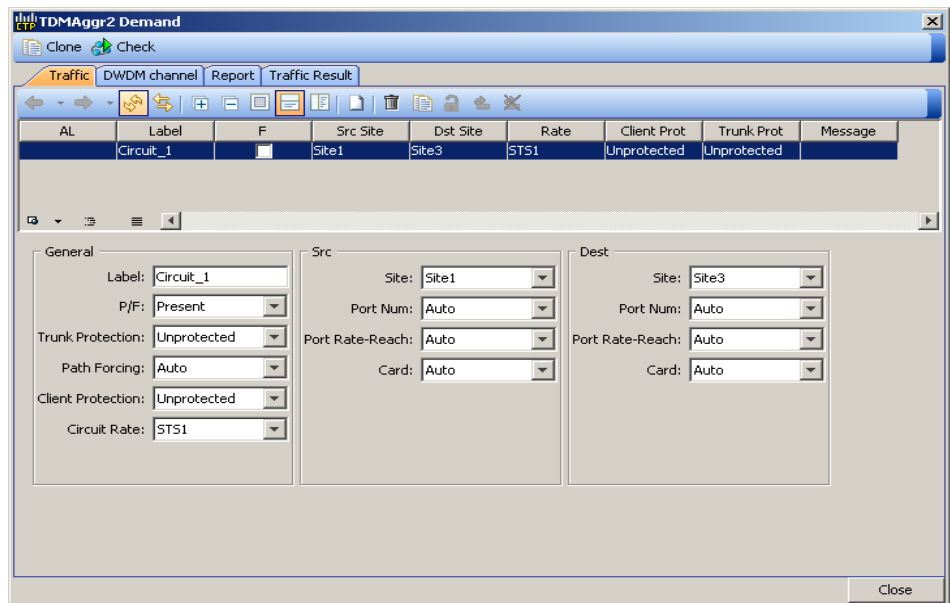

- Step 14** Click the **Check** tab on the left corner of the window to generate a report showing the circuit path in the WDM traffic channel and to check any over-allocation of bandwidth (see Figure 2-63). The report shows, in a row, each of the site on the subnet, and each span in between.
- Step 15** You can add as many TDM circuits as the bandwidth of the WDM transport channel allows. After you complete adding circuits, **Close**.

Figure 2-63 TDM Aggr Demand Window, Report Tab

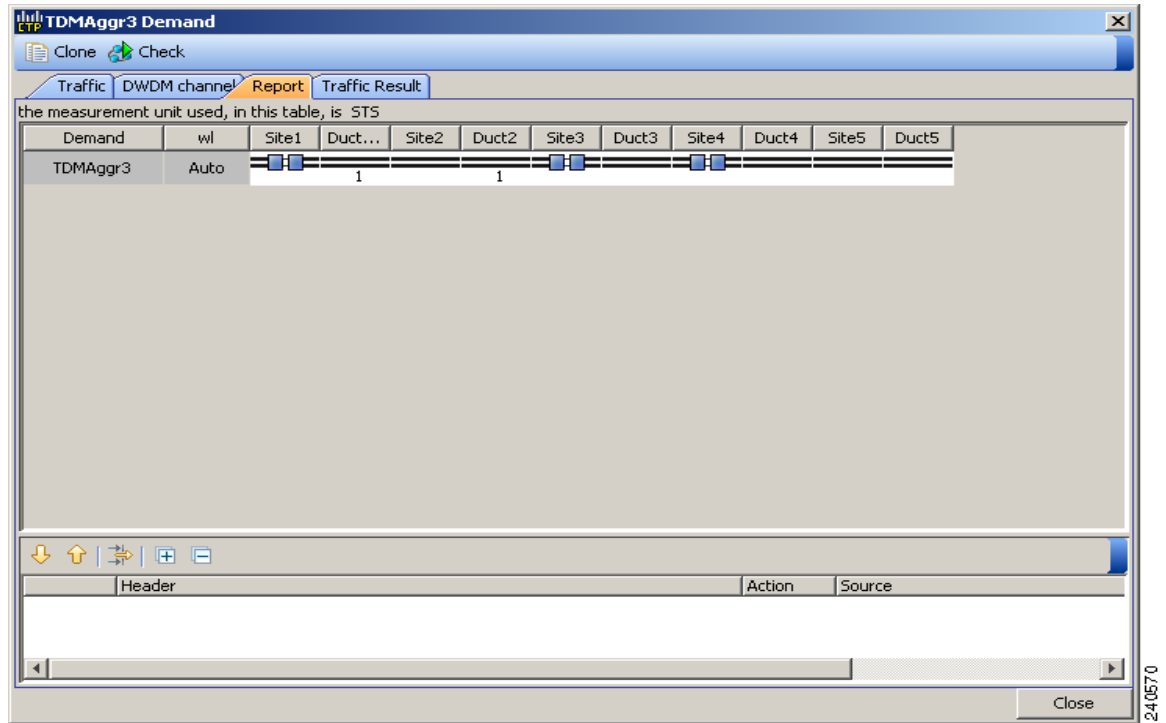

## 2.6.11 Deleting a Fiber Span

Use the following procedure to delete a fiber span from the network design:

- 
- Step 1** In the Project Explorer, right-click the network folder and choose **Expand** from the shortcut menu.
  - Step 2** In the Project Explorer, right-click the duct that you want to delete and choose **Delete** from the shortcut menu. As an alternative, you can click **Delete** in the Tasks Pane.
  - Step 3** Click **Yes** to confirm the fiber deletion.
- 

## 2.6.12 Deleting a Network

To delete a network from a project, in the Network Mgmt Tree tab click the network and choose **Delete** from the Tasks Pane. You cannot delete a network if it is the only network in a project.

## 2.6.13 Deleting Notes

Use the following procedure to delete a note from any item in the Project Explorer:

- 
- Step 1** Double-click the **Notes** folder.

- Step 2** In the Notes window, click **Go** in the Action column for the note that you want to delete. The item is highlighted in the Project Explorer.
- Step 3** Right-click the item in the Project Explorer and choose **Delete Note** from the shortcut menu.
- 

## 2.6.14 Deleting Sites

Use the following procedure to delete sites from a network. You can delete a site if the site is in the Unlocked state and does not have a traffic demand set up on it. You can delete sites from a network in the Design state only.

- Step 1** Verify that the site is in the Unlocked state in the Project Explorer pane. For more information, see the [“2.7.4 Unlocking Parameters in the Network Design”](#) section on page 2-129.
- Step 2** Delete any traffic demands. For more information, see the [“2.6.15 Deleting a Traffic Demand”](#) section on page 2-113.
- Step 3** On the NtView *Name* tab, click the Site icon and choose **Delete** from the Tasks Pane. For more information about the Cisco TransportPlanner icons, see [Appendix A, “GUI Information and Shortcuts.”](#) As an alternative, you can click **Delete** in the Tasks Pane. A confirmation message appears, asking you to confirm the deletion of the site.
- Step 4** Click **Yes** to delete the site.
- 

## 2.6.15 Deleting a Traffic Demand

A traffic demand must be in the Unlocked state before you can delete it. Use the following procedure to delete a traffic demand:

- Step 1** In the Project Explorer, right-click the network folder and choose **Expand** from the shortcut menu.
- Step 2** Verify that the demand is in the Unlocked state. For more information, see the [“2.7.4 Unlocking Parameters in the Network Design”](#) section on page 2-129.
- Step 3** Right-click the demand that you want to delete in the Project Explorer and choose **Delete** from the shortcut menu. As an alternative, you can click **Delete** in the Tasks Pane.
- 

## 2.6.16 Deleting a Traffic Subnet

Use the following procedure to delete a created traffic subnet. The Traffic Subnet ALL cannot be deleted.

- Step 1** In the Project Explorer, click the **Net > Traffic Subnets** folder to expand it.
- Step 2** Right-click the traffic subnet to be deleted and select **Delete** to delete the subnet.

- Step 3** If the traffic subnet being deleted is associated with demands, a dialog box will appear listing all the demands associated with this subnet. These associations will be removed and the demands will be moved to the Traffic Subnet ALL demand. Upon confirmation, the traffic subnet will be deleted.



**Note** Demands moved under **Traffic Subnet All** will be marked invalid and the network will not be analyzed, until the user associates the demands with either a Ring or Linear subnet.

## 2.6.17 Editing Fiber Span, Pair, and Fiber Parameters

Using the Properties pane, you can manage a fiber span, a fiber pair, and individual fibers. A fiber pair consists of two different fibers (clockwise and counter-clockwise). [Table 2-25](#) lists the properties that you can modify for a fiber span, pair, or fiber.

**Table 2-25** Editable Fiber Properties

| Property                         | Fiber Span | Fiber Pair | Fiber |
|----------------------------------|------------|------------|-------|
| Name                             | Yes        | Yes        | No    |
| Ageing loss                      | Yes        | No         | No    |
| Ageing factor                    | Yes        | No         | No    |
| Fiber type                       | Yes        | Yes        | No    |
| Fiber length                     | Yes        | Yes        | Yes   |
| Length-based loss                | Yes        | Yes        | Yes   |
| Connector loss (per site)        | Yes        | Yes        | Yes   |
| Absolute loss without connectors | Yes        | Yes        | No    |
| CD factor                        | Yes        | Yes        | No    |
| PMD factor                       | Yes        | Yes        | No    |
| Loss                             | Yes        | Yes        | Yes   |

Use the following procedure to edit fiber span, pair, and fiber parameters:

- Step 1** In the Project Explorer, right-click the **Fibers** folder and choose **Expand** from the shortcut menu.
- Step 2** In the Project Explorer tree, click one of the following. The options available for editing in the Properties pane change depending on your selection.
- To edit a fiber span, click the duct identifier.
  - To edit a fiber pair, click the fiber pair identifier.
  - To edit an individual fiber, click the fiber identifier.
- Step 3** In the Properties pane, edit the following parameters, as necessary. See [Table 2-25](#) for the properties that you can change for a fiber span, fiber pair, or individual fiber.
- Name—Type the desired name for the fiber span, pair, or fiber.
  - Ageing loss—Type the EOL aging loss value. The EOL loss per span value is added at the end of life to each discrete fiber in the network (for example, to add an EOL margin for splicing). If you set the ageing factor, you do not need to set the ageing loss.

- Ageing factor—Type the number to factor fiber aging. This factor is multiplied by the SOL total span loss without connectors. If you set the ageing loss, you do not need to set the ageing factor.
- Type—Choose the type of fiber for each span in the network.
- Length—Type the span length. The displayed unit of measure is retrieved from the Span Measurements Units field.
- Length Based Loss—Check to define if the fiber loss is specified as an absolute value or leave unchecked if fiber loss is derived from the span length.
- Connector loss [Site 1]—Type the concentrated connector loss at the end of the span.
- Connector loss [Site 2]—Type the concentrated connector loss at the end of the span.
- Abs loss w/o conn [dB]—Type the start of life link fiber loss for each span, without the connector concentrated loss. The total SOL loss without connectors is equal to the loss factor multiplied by the length. In the Length Based model, this value is calculated automatically.
- CD—Type the fiber CD factor. The default value is dependent on the selected fiber type. Any value that you enter is lost whenever you change the fiber type. Chromatic dispersion is always entered in ps/nm/km. Fiber chromatic dispersion is defined for the middle of the wavelength band. C band is defined at 1545.3 nm; L band is defined at 1590.4 nm.
- PMD—Type the PMD factor. The default value is dependent on the selected fiber type. Any value that you enter is lost whenever you change the fiber type. PMD is always entered in ps/nm/km.
- Loss—Type the value of the SOL fiber loss per kilometer used to calculate the loss of each span in the network. The fiber loss factor is always entered in dB/km.

**Step 4** As needed, view the following totals for a fiber span, fiber pair, or individual fiber on the Properties pane:

- Loss BOL—(Display only) Displays the total loss beginning of life (BOL) calculation.



**Note** BOL is also referred to as SOL.

- Loss EOL—(Display only) Displays the total loss EOL calculation.
- CD—(Display only) Displays the total chromatic dispersion.
- PMD—(Display only) Displays the total polarization mode dispersion.

## 2.6.18 Editing Fiber Spans, Pairs, and Fibers Using the Fibres Dialog Box

The Fibres Dialog lists all fiber spans, pairs, and fibers in the network. Use the following procedure to view and edit fiber parameters from the Fibres Dialog box.

**Step 1** In the Project Explorer tree, right-click the **Fibres** folder in the desired network and choose **Fibres Dialog** from the shortcut menu. The Fibres Dialog appears ([Figure 2-64](#)).

Figure 2-64 Fibres Dialog

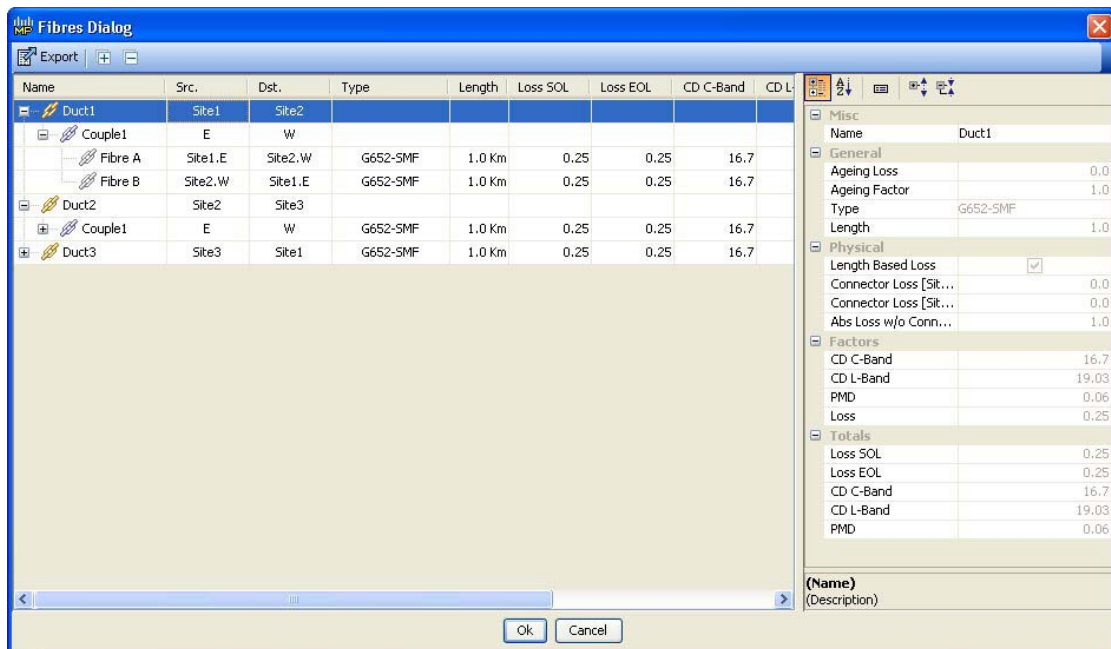

Table 2-26 describes the columns on the Fibres Dialog.

Table 2-26 Fibres Dialog Columns

| Column    | Description                                                                                                                                                                                                                                                |
|-----------|------------------------------------------------------------------------------------------------------------------------------------------------------------------------------------------------------------------------------------------------------------|
| Name      | Displays the name of the fiber span (Duct), pair (Couple), or fiber. Click the plus (+) sign by a Duct name to expand the list and show the Couple names. Click the plus (+) sign by a Couple name to expand the list and show the individual fiber names. |
| Src.      | Displays the name of the source site or interface for the fiber span, pair, or fiber.                                                                                                                                                                      |
| Dst.      | Displays the name of the destination site or interface for the fiber span, pair, or fiber.                                                                                                                                                                 |
| Type      | Displays the type of fiber for each span in the network.                                                                                                                                                                                                   |
| Length    | Displays the span length. The displayed unit of measure is retrieved from the Span Measurements Units field.                                                                                                                                               |
| Loss SOL  | Displays the total loss SOL calculation.                                                                                                                                                                                                                   |
| Loss EOL  | Displays the total loss EOL calculation.                                                                                                                                                                                                                   |
| CD C-Band | Displays the total chromatic dispersion for the C-band.                                                                                                                                                                                                    |
| CD L-Band | Displays the total chromatic dispersion for the L-band.                                                                                                                                                                                                    |
| PMD       | Displays the total polarization mode dispersion (PMD).                                                                                                                                                                                                     |
| QD C-Band | Displays the secondary order dispersion for C-band.                                                                                                                                                                                                        |
| QD L-Band | Displays the secondary order dispersion for L-band.                                                                                                                                                                                                        |
| RD        | Displays the random dispersion value.                                                                                                                                                                                                                      |

**Step 2** To edit a fiber span, pair, or fiber, click the desired item in the Fibres Dialog. The Properties pane in the right area of the Fibres Dialog displays the properties for the selected item.

**Step 3** In the Properties pane, edit the following parameters, as necessary. See [Table 2-25](#) for the properties that you can change for a fiber span, fiber pair, or individual fiber.

- Name—Type the desired name for the fiber span, pair, or fiber.
- Ageing loss—Type the EOL aging loss value. The EOL loss per span value is added at the end of life to each discrete fiber in the network (for example, to add an EOL margin for splicing). If you set the ageing factor, you do not need to set the ageing loss.
- Ageing factor—Type the number to factor fiber aging. This factor is multiplied by the SOL total span loss without connectors. If you set the ageing loss, you do not need to set the ageing factor.
- Type—Choose the type of fiber for each span in the network.
- Length—Type the span length. The displayed unit of measure is retrieved from the Span Measurements Units field.
- Length Based Loss—Check to define if the fiber loss is specified as an absolute value or leave unchecked if fiber loss is derived from the span length.
- Connector loss [Site 1]—Type the concentrated connector loss at the end of the span.
- Connector loss [Site 2]—Type the concentrated connector loss at the end of the span.
- Abs loss w/o conn [dB]—Type the start of life link fiber loss for each span, without the connector concentrated loss. The total SOL loss without connectors is equal to the loss factor multiplied by the length. In the Length Based model, this value is calculated automatically.
- CD—Type the fiber CD factor. The default value is dependent on the selected fiber type. Any value that you enter is lost whenever you change the fiber type. Chromatic dispersion is always entered in ps/nm/km. Fiber chromatic dispersion is defined for the middle of the wavelength band. C band is defined at 1545.3 nm; L band is defined at 1590.4 nm.
- PMD—Type the PMD factor. The default value is dependent on the selected fiber type. Any value that you enter is lost whenever you change the fiber type. PMD is always entered in ps/nm/km.
- Loss—Type the value of the SOL fiber loss per kilometer used to calculate the loss of each span in the network. The fiber loss factor is always entered in dB/km.

Cisco TransportPlanner updates the Fibres Dialog box with the new value.

**Step 4** As needed, view the following totals for a fiber span, fiber pair, or individual fiber on the Properties pane:

- Loss BOL—(Display only) Displays the total loss BOL calculation.



**Note** BOL is also referred to as SOL.

- Loss EOL—(Display only) Displays the total loss EOL calculation.
- CD—(Display only) Displays the total chromatic dispersion.
- PMD—(Display only) Displays the total polarization mode dispersion.

**Step 5** Click **OK**.

## 2.6.19 Modifying Site Structure, Functionality, and Type

You can edit a site after you have created it using the Network Creation Wizard. To create a site, see the “2.3 Creating a Project” section on page 2-36. The following properties of a site can be modified:

- Site Structure
- Functionality
- Type

To edit the properties of a site:

- Step 1** In the Project Explorer tree, click the Sites folder. The list of sites included in the network appears (Figure 2-65).

**Figure 2-65** Sites List

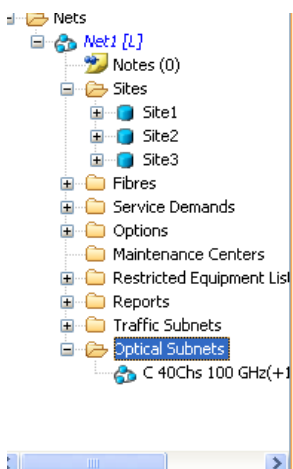

- Step 2** Right-click the site you want to have the properties modified and select **Edit**. The **Edit** dialog box appears (Figure 2-66).

**Figure 2-66** Sites Edit Dialog

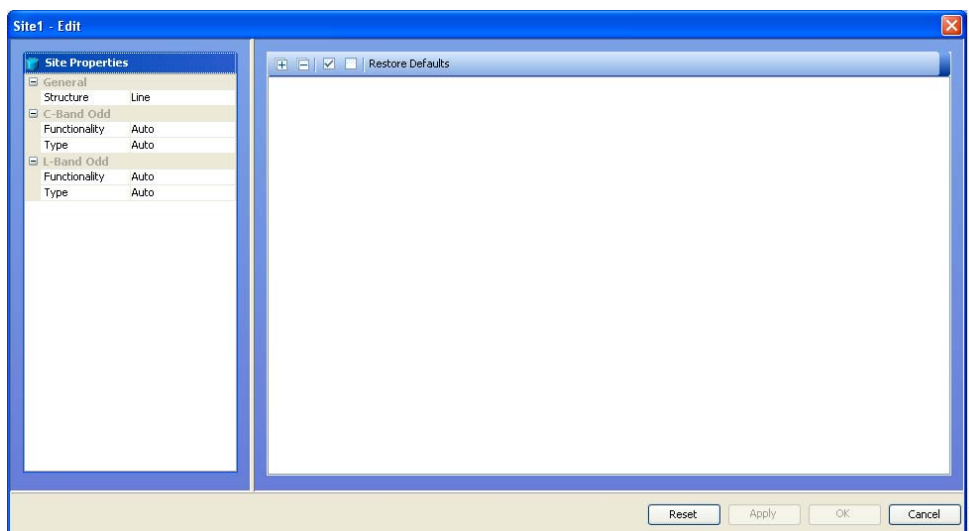



- Step 3** Select the new Structure, C-Band rules, and L-Band rules from General, C-Band Odd, and L-Band Odd groups respectively. For details on site design rules, see [Table 2-24 on page 2-96](#).
- Step 4** Select the lock/unlock rules on the right side of the Edit dialog. For details on site modification unlock instances/parameters, see [Table 2-28 on page 2-119](#).
- Step 5** Click **Apply**. The selected changes are applied to the site.
- Step 6** Click **OK** to save the changes and exit the **Edit** dialog box.

**Note**

When you modify a site, Cisco TransportPlanner does not allow you to decrease the number of node sites. For example, it would not be possible to change a Multi-degree site (created using the Network Creation Wizard) to a Line+ site; but, a Line site can be changed to a Multi-Degree.

[Table 2-27](#) shows the structure modifications that you can make using Cisco TransportPlanner.

**Table 2-27 Permitted Structure Modifications**

| Starting Structure    | Ending Structure          |
|-----------------------|---------------------------|
| Terminal or Terminal+ | Line, Line+, Multi-Degree |
| Line or Line+         | Multi-Degree              |

When you modify the properties of a site, Cisco TransportPlanner checks the compatibility between the original site properties and the new configurations that you make on each site. It also checks for consistency in the add/drop section and/or in the amplifier/DCU section and displays a warning message in case of inconsistency. Cisco TransportPlanner then unlocks the related unit instances and/or parameters for you to make modifications. If the units were forced, Cisco TransportPlanner removes the forcing to perform the required modifications.

If the starting instances/parameters are consistent, even if not optimal for the ending configuration, Cisco TransportPlanner will warn the user about possible sub-optimization, but the related unit/parameter will be kept Locked (with its Layout property).

Site modifications that require unlocking of some instances/parameters are provided in [Table 2-28](#).

**Table 2-28 Site Modification Unlock Instances/Parameters**

| Starting Configuration | Ending Configuration | Mandatory Unlock           | Suggested Unlock    |
|------------------------|----------------------|----------------------------|---------------------|
| Line, PT               | Line, OLA            | All amplifiers/DCU section | -                   |
| Line, OSC-site         | Line, OLA            | All amplifiers cards.      | -                   |
| Line, OLA              | Line, A/D            | None.                      | All amplifier cards |
| Line, OLA              | Line, ROADM          | None.                      | All amplifier cards |
| Line, A/D, OADM-xc     | Line, ROADM          | All OADM-xc cards.         | All amplifier cards |
| Line, HUB, WSS         | Line, ROADM          | None.                      | All amplifier cards |
| Term, ROADM, WSS       | Line, ROADM, WSS     | None.                      | All amplifier cards |
| Term, ROADM, WSS       | Multi-degree, WSS    | 32-DMX-O (if present)      | All amplifier cards |

Table 2-28 Site Modification Unlock Instances/Parameters

| Starting Configuration | Ending Configuration            | Mandatory Unlock                                    | Suggested Unlock                                         |
|------------------------|---------------------------------|-----------------------------------------------------|----------------------------------------------------------|
| Line, ROADM, WSS       | Multi-degree, WXC,<br>PP-MESH-4 | 32-DMX-O (if present)                               | WSS cards, 40-MUX-C is the default; all amplifier cards  |
| Line, ROADM, WSS       | Multi-degree, WXC,<br>PP-MESH-8 | 32-DMX-O (if present),<br>AMP-17 cards (if present) | WSS units (40-MUX-C is the default), all amplifier cards |

## 2.6.20 Adjusting Site Layout

In the Layout View of a design, Cisco TransportPlanner allows you to move a selected card from its starting position to another destination slot position. Site layout adjustments can only be done on a network that has been analyzed and is any administrative state (Design, Upgrade, or Installation). You can move both present and forecast cards.

Use the following procedure to move a card to a new position:

- Step 1** Right-click on the site for which you want to move the cards in the rack and choose **Layout**. (See [Figure 2-67](#)). The Details dialog box appears (See [Figure 2-68](#)).

Figure 2-67 Selecting the Layout View

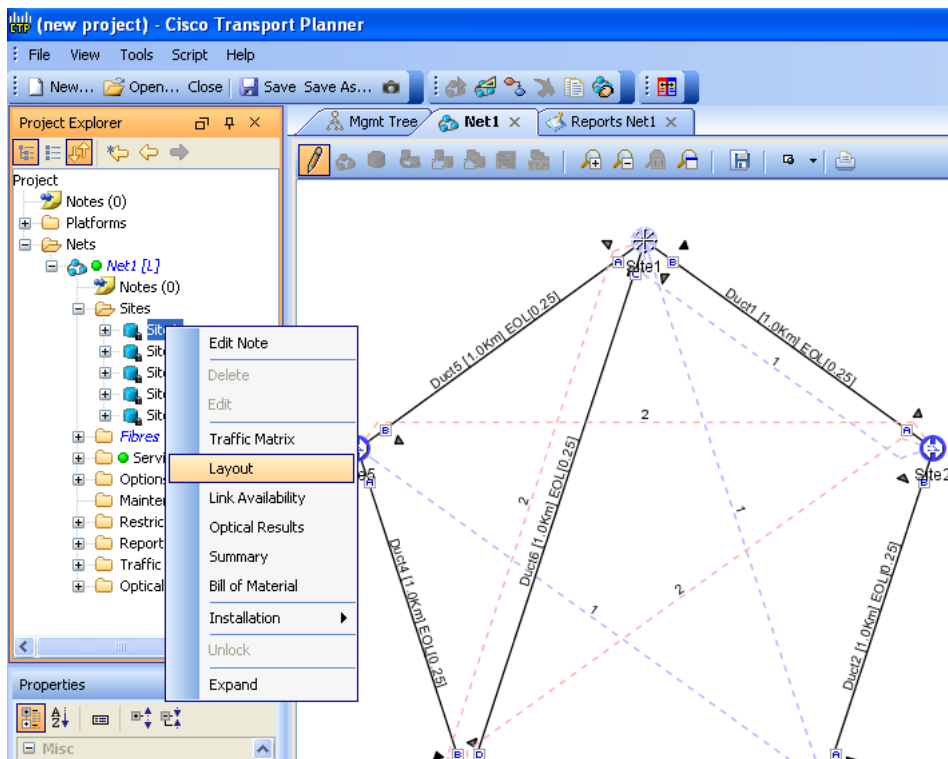
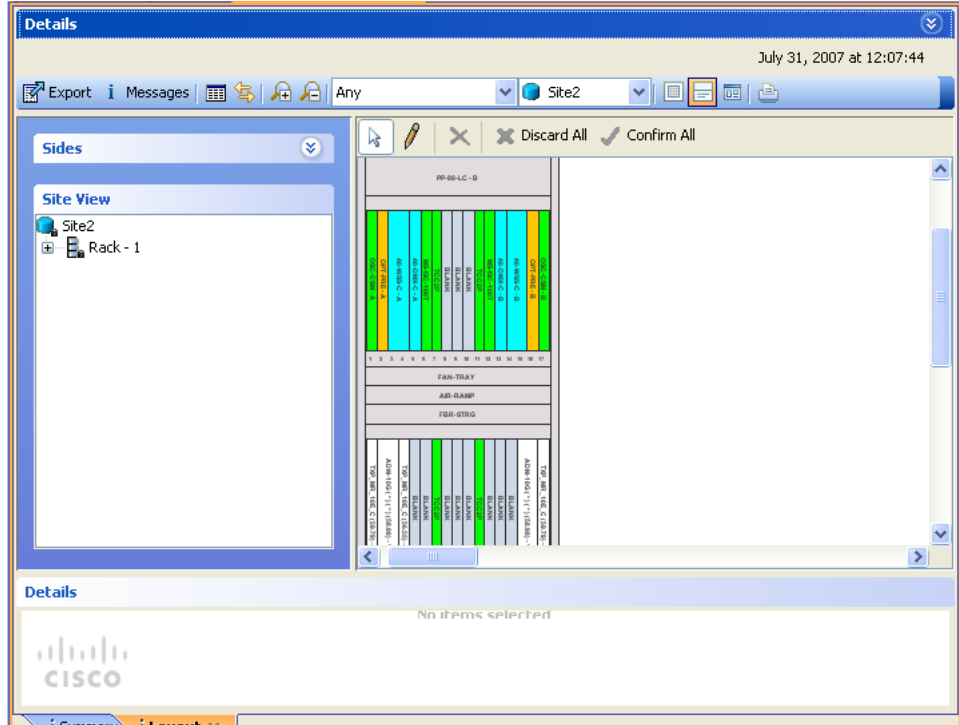

Figure 2-68 Details Dialog Box



- Step 2** Choose **Draw Mode** and then click the card and move it to the desired slot in the shelf.
- Step 3** Click **Confirm All** to confirm the changes made. When you confirm all site adjustments, Cisco TransportPlanner automatically unlocks both the source and destination slot positions.



**Note**

The destination slot position must be within an existing shelf on the existing rack. A destination slot can be any empty slot or any other slot containing a client/OTS card. It cannot be a slot the user has already defined as destination for another position change (in the current layout adjustment session).

Table 2-29 lists the allowed site layout adjustments.

**Table 2-29 Allowed Site Layout Movements**

| From/To                      | OTS              | Unprotected Fiber Switched TXP-MXP | Unprotected LC | 1+1 TXP-MXP | 1+1 LC                                       | Y cable TXP-MXP |
|------------------------------|------------------|------------------------------------|----------------|-------------|----------------------------------------------|-----------------|
| OTS                          | Yes <sup>1</sup> | No                                 | No             | Yes         | No                                           | No              |
| Unpr./Fiber Switched TXP-MXP | Yes              | No                                 | No             | Yes         | No                                           | No              |
| Unprotected LC               | No               | No                                 | Yes            | No          | No for different shelves; Yes for same shelf | No              |

**Table 2-29 Allowed Site Layout Movements**

| From/To            | OTS | Unprotected<br>Fiber<br>Switched<br>TXP-MXP | Unprotected<br>LC | 1+1<br>TXP-MXP | 1+1<br>LC | Y cable<br>TXP-MXP |
|--------------------|-----|---------------------------------------------|-------------------|----------------|-----------|--------------------|
| 1+1<br>TXP-MXP     | Yes | No                                          | No                | Yes            | No        | No                 |
| 1+1 LC             | No  | No                                          | Yes               | No             | Yes       | No                 |
| Y cable<br>TXP-MXP | Yes | No                                          | No                | Yes            | No        | Yes                |

1. For all site movements marked as 'Yes,' Cisco TransportPlanner will create a reverse link. For example, when a Y cable TXP is moved to an OTS card, a reverse link, that is, a link between the OTS card and the Y cable TXP will be created automatically.

You need to ensure that the following conditions are met when doing layout adjustments:

- A pair of TXP/MXP cards that are a part of a Y-cable protection group must stay within the same shelf.
- A pair of ADM-10G cards that are a part of the same ADM peer group must stay within the same shelf.
- A pair of line cards that are a part of a protection group must stay within the same shelf.
- A pair of line cards in a site that are a part of a P-ring circuit must stay within the same shelf.



**Note** For any other kind of forced position, Cisco TransportPlanner will not prevent you from forcing any destination position even if they do not match some layout recommended constraints (for example, OSMINE or TXP/MXP 1+1 Client protection).

## 2.6.21 Exporting the Fiber Spans, Pairs, and Fibers in a Network

Use the following procedure to export all spans, pairs, and single fibers in a network in XLS format:

- 
- Step 1** In the Project Explorer tree, right-click the **Fibres** folder in the desired network and choose **Fibres Dialog** from the shortcut menu. The Fibres Dialog appears (Figure 2-64).
- Step 2** Click **Export**. The Fibres Export dialog box appears.
- Step 3** Navigate to the desired directory, type the XLS filename, and click **Save**.
- 

## 2.6.22 Arranging Sites

Sites can be arranged into four different configurations. Use the following procedure to arrange the sites into a configuration or to move all of the sites so that they appear in the Cisco TransportPlanner window:

- 
- Step 1** Click the **NtView Name** tab.
- Step 2** Click the Arrange Sites drop-down list, and choose one of the following:



**Note** All shapes are approximations.

- Fit to visible rectangle view—Zooms to display all sites in the NtView *Name* tab.
- Arrange to an ellipse—Rearranges all sites in an ellipse form (Figure 2-69).

**Figure 2-69** Ellipse Shape

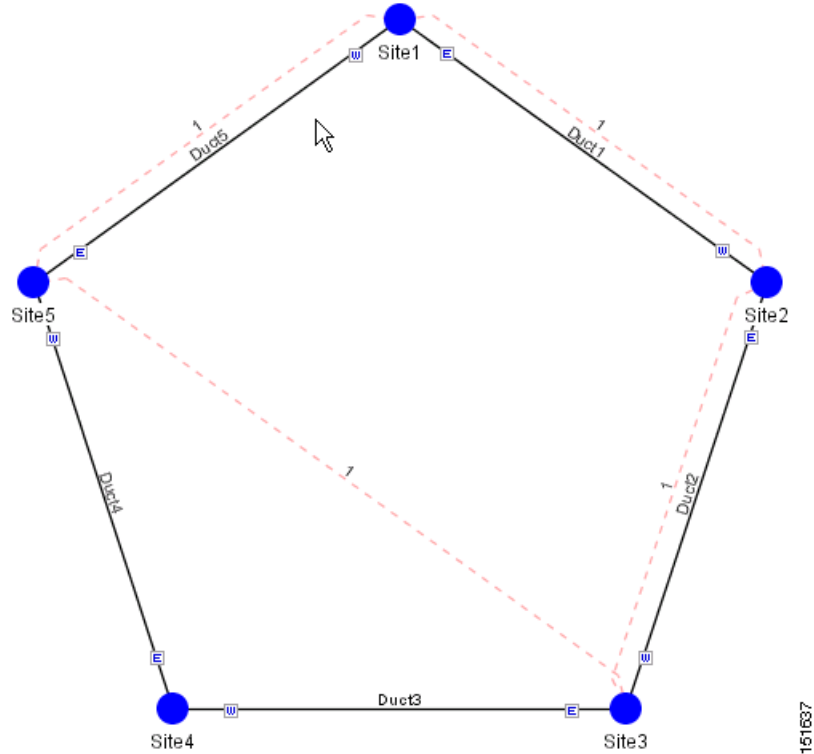

- Arrange to a square—Rearranges all sites in a square form so that the sites appear clockwise around the square (Figure 2-70). To complete a full square, this arrangement requires at least four sites.

Figure 2-70 Square Shape

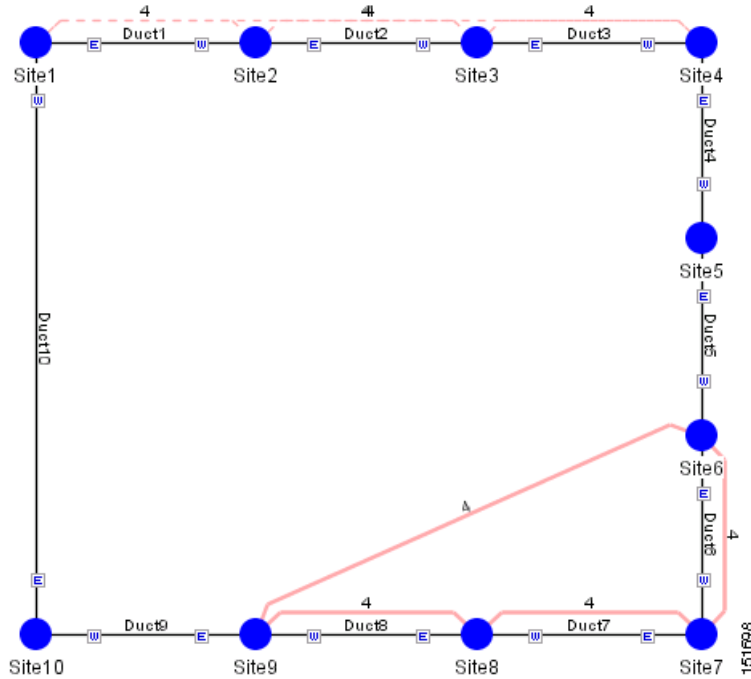

- Arrange to a snake—Rearranges all sites so that they cross the NtView *Name* tab from right to left and then left to right in a serpentine, linear format (Figure 2-71).

Figure 2-71 Snake Shape

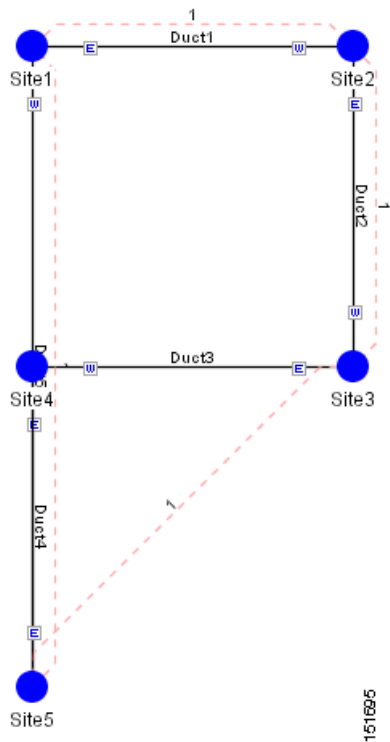

- Arrange to a double ring—Rearranges the sites into a dual ring format (Figure 2-72).

**Figure 2-72 Double Ring Shape**

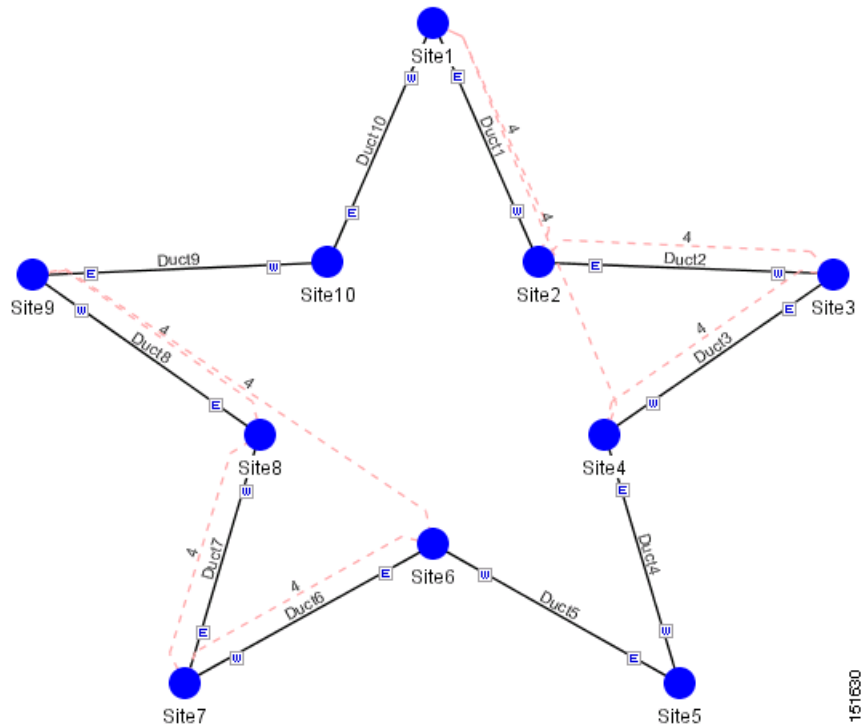

- Arrange to Fit to Maximum Rectangle View—Arranges sites in proportion, using all network map area (Figure 2-73).

Figure 2-73 Fit to Maximum Rectangle View Shape

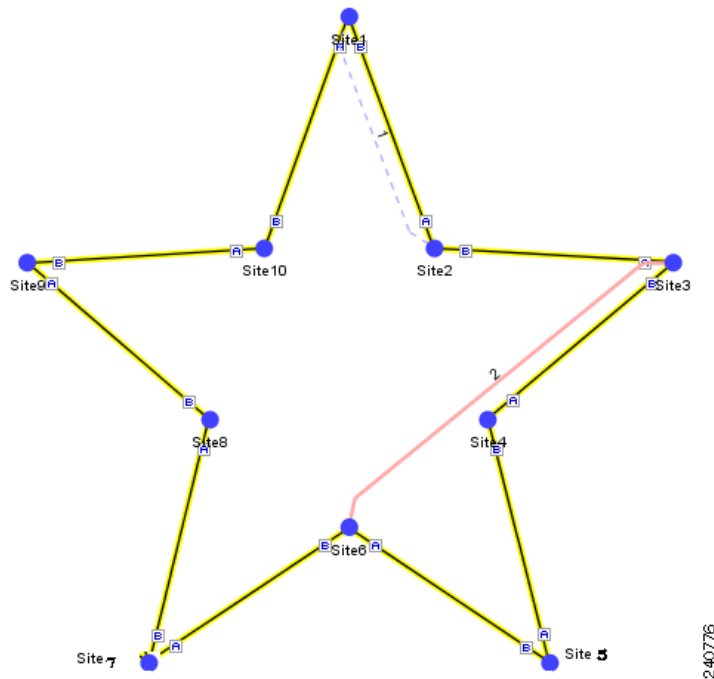

## 2.7 Managing the Network Design

After creating and analyzing a network design, you must prepare the design for installation at a customer site. After a network has been installed, you can reanalyze to correct any problems.

Network designs have several possible states:

- **Design**—The initial state for any new network design. You can add, delete, or change any aspect of the network design. In the Design state, no locks exist. After analyzing a design, you can put it back into the Design state to modify it by choosing Design in the Tasks Pane.
- **Design-Analyzed**—The state of the network design after you run the network analyzer. All reports are available and updated. You cannot change any aspect of the network design. You can modify the BoM, such as changing global discounts and spare parts. You can return to the Design state after analyzing the network by choosing Design in the Tasks Pane.
- **Copy**—A copy of a network. You can create a copy of a network in any state. A copy is useful for testing different design options. You can copy a network before or after analyzing it. A copied network inherits the set of project options defined in the original network. For more information, see the “[2.7.1 Creating a Copy of the Network](#)” section on page 2-127.
- **Install**—A network is initially designed with theoretical fiber values (such as loss, length, etc.). When a network is installed in the field, you can move the network into the Install state so that you can enter and check the real fiber parameter values. You can create an Install network from a network in the Design-Analyzed or Upgrade-Analyzed state. A network in the Install state inherits the set of project options defined in the analyzed network. All sites in an Install network are locked. You cannot modify any aspect of the network design except the span parameters and (on unlocked sites) amplifiers. You can, however, modify the BoM. All routed circuits are fixed, and cannot be changed while in this state. For more information, see the “[2.7.2 Creating a Network in the Install State](#)” section on page 2-127.



- **Install-Analyzed**—The state of the Install network design after you run the network analyzer. All reports are available and updated. Cisco TransportPlanner locks all sites, spans, demands, and equipment when a network is in the Install-Analyzed state.
- **Upgrade**—During network design, you define a number of the channels to be implemented at the present time and a number of channels to be implemented in the future (forecast). After installing the network, you might decide to implement the forecast circuits. To do this, you create an Upgrade network and then select the forecast or traffic demand services that you want to implement. You can create an Upgrade network from a network in the Design-Analyzed or Install-Analyzed state. You can unlock specified parameters to alter the design to include forecasted channels and traffic demands. A network in the Upgrade state inherits the set of project options defined in the analyzed network. For more information, see the [“2.7.3 Creating an Upgrade Network” section on page 2-128](#).
- **Upgrade-Analyzed**—The state of the Upgrade network design after you run the network analyzer. All reports are available and updated. Cisco TransportPlanner locks all sites, spans, demands, and equipment when a network is in the Upgrade state.

To complete the procedures in this section, you must have a project open and the network(s) loaded. See the [“2.1.1 Opening a Project” section on page 2-15](#) and the [“2.1.2 Loading and Unloading Networks” section on page 2-15](#).

## 2.7.1 Creating a Copy of the Network

To create a copy of a network in any state, right-click the network and choose **Copy** from the shortcut menu. A new copy appears in the Network Mgmt Tree tab.

---

## 2.7.2 Creating a Network in the Install State

Use the following procedure to create a network in the Install state:

- 
- Step 1** If the network is not analyzed, complete the [“2.4 Analyzing the Network” section on page 2-62](#).
  - Step 2** Click the **Networks Mgmt Tree** tab.
  - Step 3** Right-click the network and choose **Install** from the shortcut menu. A new network appears in the Networks Mgmt Tree in the Install state. All results from the analyzed network are imported into the Install network and are placed in the Locked mode.
  - Step 4** Make the necessary changes to the Install network. You can edit the following fiber parameters: fiber loss value, fiber CD, fiber PMD, and fiber length. See the [“2.6.17 Editing Fiber Span, Pair, and Fiber Parameters” section on page 2-114](#). Cisco TransportPlanner also allows you to unlock site parameters for modification. To change site parameters, see the [“2.6.3 Editing Site Parameters” section on page 2-92](#).
  - Step 5** In the Networks Mgmt Tree view, click the **Analyze Network** icon in the toolbar. For more information about the Cisco TransportPlanner icons, see [Appendix A, “GUI Information and Shortcuts.”](#) The TransportPlanner Analyzer status window appears to indicate the progress. As an alternative, click **Analyze** in the Tasks Pane. The Cisco TransportPlanner analysis status bar indicates when the network analysis is complete. The network now appears in the Install-Analyzed state.

**Note**

If you have changed parameters that are inconsistent with the present network layout (for example, if you set an output tilt value that the amplifier cannot reach), during network analysis an error message on the Analyzer Messages pane identifies which parameter is causing the problem. Warning and error messages help you identify problems with your current design. For a list of all system messages, see [Appendix C, “System Messages.”](#)

- Step 6** When you have analyzed the network and are satisfied with the results, import the new generated installation parameters to each site of the network. For more information, see the [“2.5.2 Saving the NE Update File” section on page 2-65.](#)

## 2.7.3 Creating an Upgrade Network

In an Upgrade network, you can perform the following tasks:

- Modify the fiber span properties (such as length, dispersion, PMD coefficient, excess losses, and aging).
- Add or delete traffic.
- Convert forecasted traffic to present traffic.
- Convert ROADM traffic to present traffic.
- Modify the type of a node.
- Force the presence or the absence of a card or a module (this includes amplifiers, OSC modules, OADM cards, and DCU modules).

In an Upgrade network, you can force certain installation parameters:

- Amplifier per-channel output power setpoint
- Amplifier output tilt setpoint
- OADM card aggregate output power setpoint
- Full multiplexer/demultiplexer or ROADM output power setpoint

You cannot change the following parameters when in Upgrade state:

- Node input channel fail threshold
- Node OSC channel fail threshold
- Preamplifier input power threshold
- OADM card aggregate input power setpoint
- Full muxponder/demuxponder or ROADM input power setpoint
- Channels drop power

When upgrading a network that has a point-to-point demand, you can:

- Move Future circuits to become Present. This can be done without unlocking the circuit.
- Open an optical-bypass channel. This can be done without unlocking the circuit.
- Add new, present, or future point-to-point services to the existing demand.
- Delete any present or future channel originally defined in the baseline network.

- Change any unlocked point-to-point circuit or unlocked point-to-point service demand parameter.

When upgrading a network that has a any-to-any demand, you can:

- Move any of the Any-to-Any (future) services to the Present. This can be done without unlocking the circuit.
- Create a new Any-to-Any demand on an already existing Any-to-Any group.
- Create a new Any-to-Any group.
- Delete an existing Any-to-Any demand from an Any-to-Any group.
- Delete an Any-to-Any Group with all its Any-to-Any demand.

**Note**

Any-to-Any services that have been moved to Present will be represented as Point-to-Point services.

Use the following procedure to put a network in the Upgrade state:

- 
- Step 1** If the network is not analyzed, complete the “[2.4 Analyzing the Network](#)” section on page 2-62.
- Step 2** Click the **Networks Mgmt Tree** tab.
- Step 3** Right-click the analyzed network and choose **Upgrade** from the shortcut menu. A new Upgrade network appears in the Networks Mgmt Tree tab. All results from the analyzed network are imported into the Upgrade network.
- Step 4** Make the necessary changes to the Upgrade network. For more information, see the “[2.6.17 Editing Fiber Span, Pair, and Fiber Parameters](#)” section on page 2-114 and the “[2.6.3 Editing Site Parameters](#)” section on page 2-92.
- Step 5** In the Networks Mgmt Tree view, click the **Analyze Network** icon in the toolbar. For more information about the Cisco TransportPlanner icons, see [Appendix A, “GUI Information and Shortcuts.”](#) The TransportPlanner Analyzer status window appears to indicate the progress. As an alternative, click **Analyze** in the Tasks Pane in any view. The Cisco TransportPlanner analysis status bar indicates when the network analysis is complete. The network now appears in the Upgrade-Analyzed state.

**Note**

If you have changed parameters that are inconsistent with the present network layout (for example, if you set an output tilt value that the amplifier cannot reach), during network analysis an error message on the Analyzer Messages pane identifies which parameter is causing the problem. Warning and error messages help you identify problems with your current design. For a list of all system messages, see [Appendix C, “System Messages.”](#)

## 2.7.4 Unlocking Parameters in the Network Design

The Locked state occurs when you did not set (force) any value for a parameter and instead chose Auto. During network analysis, Cisco TransportPlanner assigns a value for each parameter set with Auto and puts them in the Locked state. The Locked state indicates that the next time the network is analyzed, the analyzer cannot change the value. Locking a site forces the presence or absence of all preamplifiers, boosters, add/drop filters, and DCU cards required by the site/network as a result of running the analyzer previously. Locked elements are indicated by a closed padlock icon in the Project Explorer ([Figure 2-74](#)). For more information on the Auto, forced, and locked states, see the “[1.6 Auto, Forced, and Locked Parameters](#)” section on page 1-11.

**Figure 2-74** Locked Sites in the Project Explorer View

To unlock network components to edit parameters, right-click the desired element in the Project Explorer and choose **Unlock** from the shortcut menu.

## 2.7.5 Creating a JPEG of the Network Design

Use the following procedure to create a snapshot of your network design in JPEG format:

- 
- Step 1** Click the **NtView Name** tab.
  - Step 2** Complete the “[2.6.22 Arranging Sites](#)” section on page 2-122 as necessary so that the sites in the network appear in the tab in the desired arrangement.
  - Step 3** Click the Save network view image icon in the toolbar.
  - Step 4** In the Save network view image dialog box, navigate to the desired directory.
  - Step 5** Enter the file name in the File Name field and click **Save**.
- 

## 2.7.6 Upgrading a Release from 7.0 to 8.5

Use the following steps to upgrade a release saved as a Cisco TransportPlanner ONS Software R7.0 project to release 8.5.

- 
- Step 1** From the File menu, click Open to load the saved Cisco TransportPlanner 7.0 project.
  - Step 2** Right-click on the network loaded on the Project Explorer and select Release Upgrade. Cisco TransportPlanner automatically creates a copy of the initially loaded network and updates the system release to ONS Software Release 8.5. The newly created network copy will be moved into the Upgrade administrative status.



### Note

The tool allows you to manually enter the details of a deployed network even if the Cisco TransportPlanner design file is not available. You can perform a release upgrade only on a network that has been analyzed. Also, a release upgrade can be performed only on a loaded network that has been designed and saved with the current Cisco TransportPlanner release and with the ONS Software Release that is the last supported by Cisco TransportPlanner.

---

## 2.8 Generating a BoM

You can generate a BoM when a network is in the Install or Upgrade state, or after you have successfully analyzed your network design. The price database selected during project creation is used to generate the BoM.

To complete the procedures in this section, you must have a project open and the network(s) loaded. See the “[2.1.1 Opening a Project](#)” section on page 2-15 and the “[2.1.2 Loading and Unloading Networks](#)” section on page 2-15.

### 2.8.1 Viewing BoM Report Totals

Use the following procedure to view the BoM report totals:

- 
- Step 1** Click the **Networks Mgmt Tree** tab and click the network.
- Step 2** In the Tasks Pane, click **Bill of Material**. The Bill of Material tab appears. As an alternative, you can access this report by choosing **Bill of Materials** from the Reports folder in the Project Explorer tree.
- The upper section of the BoM tab (in the Net view, Site view, and Spare subtabs) displays the following information:
- **BoM total discounted**—Displays the price for the overall network (without spare parts) for each item in the BoM. If **Use global discount** is checked, the total includes the discount from the **Global discount percentage** field.
  - **Spare total discounted**—Displays the price for all of the recommended spare parts in all of the maintenance centers for the overall network. It is the sum of each spare item using the discounted price. The total appears after you check the **Spare Part Report** check box.
  - **BoM + Spare total discounted**—Displays the sum of the BoM total discounted price and spare total discounted price.
  - **Price List**—Displays the name of the price list database selected for the project.
  - **Price List last update**—Displays the date that the selected price list was last updated.
  - **Currency**—Displays the value of the currency used for each of the price values as specified within the selected price list database.
- Step 3** To use the Multishelf Management Integrated Kit bundle when generating the BoM instead of the single items, check **Use MSM bundle**.
- Step 4** Check **Spare Part Report** to include the spare parts in the report totals.
-  **Note** You can only check the Spare Part Report check box if the network is in Design mode.
- 
- Step 5** The **Global discount percentage** field shows the percentage from the **Global Discount Percentage** option in the **Default Project Options** window. To change the global discount for the entire network, check **Use global discount** and enter a new global discount in the form of a percentage in the **Global discount percentage** field. The global discount is applied to all components in the BoM and will overwrite any discount specified in the **Global Price List**.
-

## 2.8.2 Generating a Network BoM

Use the following procedure to generate a BoM for the network:

- Step 1** Click the **Networks Mgmt Tree** tab and click the network.
- Step 2** In the Tasks Pane, click **Bill of Material**. The Bill of Material tab (Figure 2-75) appears. The Net View subtab is selected by default. Items that are not found appear in yellow in the BOM.

**Figure 2-75 Bill of Material Tab, Net View Subtab**

Details  
April 26, 2006 at 11:11:30

Export Messages

BoM total discounted: 224,880.00  
Spare total discounted: 0.00  
BoM + Spare total discounted: 224,880.00

Price List: Master Price DB  
Price List last update: Wed Apr 26 11:07:42 CDT 2006 (CCO)  
Currency: Usd

Use MSM Bundle  Use Spare Parts  Use Global Discount Global Discount (%) 0.0

BoM Spare

| Product ID        | Description                                       | Quan... | Unit price | Unit Disco... | Total price | Dis |
|-------------------|---------------------------------------------------|---------|------------|---------------|-------------|-----|
| 15454-EAP-MF      | Ethernet Adapter Panel Mechanical Frame           | 2       | 400.00     | 0.0 %         | 800.00      |     |
| 15454-AIR-RAMP=   | ONS 15454 Air Ramp / Baffle for the ANSI Cha...   | 2       | 120.00     | 0.0 %         | 240.00      |     |
| 15454-FBR-STRG=   | Fiber Storage Shelf                               | 2       | 800.00     | 0.0 %         | 1,600.00    |     |
| 15454-FTA3-T      | Shelf Fan Tray Assembly, ANSI, 15454, HPCFM, ...  | 2       | 500.00     | 0.0 %         | 1,000.00    |     |
| 15454-SA-HD       | 15454 SA HD NEB53 ANSI w/ RCA and Ship Kit        | 2       | 2,000.00   | 0.0 %         | 4,000.00    |     |
| 15454-EAP         | Ethernet Adapter Panel                            | 4       | 550.00     | 0.0 %         | 2,200.00    |     |
| 15454-BLANK=      | Empty slot Filler Panel                           | 18      | 225.00     | 0.0 %         | 4,050.00    |     |
| 15454-MS-ISC-100T | MultiShelf Management Integrated Switch Card      | 4       | 10,000.00  | 0.0 %         | 40,000.00   |     |
| 15454-TCC2P-K9    | Timing Communications Control Two Plus, I-Temp    | 4       | 3,000.00   | 0.0 %         | 12,000.00   |     |
| 15454-R7.0.05WK9  | Rel. 7.0.0 Feature Pkg., CD, Right To Use Lice... | 2       | 1,995.00   | 0.0 %         | 3,990.00    |     |
| SF15454-R7.0.0K9  | Rel. 7.0.0 SW, Pre-loaded on TCC                  | 4       | 0.00       | 0.0 %         | 0.00        |     |
| 15454-OSC-C5M=    | ONS 15454 Combiner and Separator with OSC ...     | 4       | 6,500.00   | 0.0 %         | 26,000.00   |     |
| 15454-AD-1C-58.1= | ONS 15454 OADM - 1 Chn - 100GHz - 1558.17         | 2       | 9,500.00   | 0.0 %         | 19,000.00   |     |
| 15454-10E-L1-C=   | 15454 10G Multi-Rate Transponder- EFEC- Full ...  | 2       | 50,000.00  | 0.0 %         | 100,000.00  |     |
| ONS-XC-10G-51     | XFP - OC192/STM64/10G - 1310 NR - SM LC           | 2       | 4,800.00   | 0.0 %         | 9,600.00    |     |

Net view Site view

Summary : Bill Of Material

Table 2-30 describes the Net view subtab columns. See the “2.8.1 Viewing BoM Report Totals” section on page 2-131 for a description of the data, check boxes, and fields at the top of the window.

**Table 2-30 BoM Net View Columns**

| Column Label  | Description                                                                                                                                                                                                                                                                                                         |
|---------------|---------------------------------------------------------------------------------------------------------------------------------------------------------------------------------------------------------------------------------------------------------------------------------------------------------------------|
| Product ID    | Displays the ordering code used to order the BoM from Cisco.                                                                                                                                                                                                                                                        |
| Description   | Displays a description of the product.                                                                                                                                                                                                                                                                              |
| Quantity      | Displays the number of specific products in the BoM.                                                                                                                                                                                                                                                                |
| Unit price    | Displays the price for each unit. If the price does not appear, Invalid will display. This occurs when the price list reports “NaN” (Not a Number) for the item because the price list has never been updated. Invalid items appear in the list in red. Items that have not been updated from CCO appear in yellow. |
| Unit Discount | Displays the per-unit discount amount that you assigned in the Global Discount Percentage field. If you leave the field blank, the field displays the default value from the Price List database.                                                                                                                   |

**Table 2-30** BoM Net View Columns (continued)

| Column Label           | Description                                                                                                                                        |
|------------------------|----------------------------------------------------------------------------------------------------------------------------------------------------|
| Total price            | Displays the total price of the products before applying the discount.                                                                             |
| Discounted Total Price | Displays the total price of the products after applying the discount.                                                                              |
| Site #                 | Displays the number of products to be assigned to a particular site. The number of Site columns is the same as the number of sites in the network. |

**Step 3** To close the Bill of Material report, click the **X** in the upper right corner of the Bill of Material tab.

## 2.8.3 Generating a Site BoM

A site BoM lists all of the hardware and software parts required for the system to work as designed at a given site. Use the following procedure to generate a BoM for a site:

- Step 1** Click the **NtView Name** tab and click the site.
- Step 2** In the Tasks Pane, click **Bill of Material**. The Site view subtab is selected by default (Figure 2-76). Items that do not appear in the price list appear in red.

**Figure 2-76** Bill of Material Tab, Site View Subtab

Networks Mgmt Tree | NtView Net1 x | NtReports Net1 x

Details April 26, 2006 at 11:11:30

Export | Messages

BoM total discounted: 224,880.00 Price List: Master Price DB  
 Spare total discounted: 0.00 Price List last update: Wed Apr 26 11:07:42 CDT 2006 (CCO)  
 BoM + Spare total discounted: 224,880.00 Currency: Usd

Use MSM Bundle  Use Spare Parts  Use Global Discount Global Discount (%) 0.0

BoM Spare

| Name                                             | PID             | Quantity | Unit Price | Unit Disco... |
|--------------------------------------------------|-----------------|----------|------------|---------------|
| Site1                                            |                 |          |            |               |
| Mech Unit                                        |                 |          |            |               |
| 15454 SA HD NEBS3 ANSI w/ RCA and Ship Kit       | 15454-SA-HD     | 1        | 2,000.00   | 0.0           |
| Empty slot Filler Panel                          | 15454-BLANK=    | 9        | 225.00     | 0.0           |
| Ethernet Adapater Panel                          | 15454-EAP       | 2        | 550.00     | 0.0           |
| Ethernet Adapater Panel Mechanical Frame         | 15454-EAP-MF    | 1        | 400.00     | 0.0           |
| Fiber Storage Shelf                              | 15454-FBR-STRG= | 1        | 800.00     | 0.0           |
| ONS 15454 Air Ramp / Baffle for the ANSI Chassis | 15454-AIR-RAMP= | 1        | 120.00     | 0.0           |
| Shelf Fan Tray Assembly,ANSI,15454, HPCFM, I...  | 15454-FTA3-T    | 1        | 500.00     | 0.0           |
| Common Unit                                      |                 | 4        |            |               |
| SW License                                       |                 | 3        |            |               |
| Opt Common Unit                                  |                 | 2        |            |               |
| Oadm                                             |                 | 1        |            |               |
| Transponder                                      |                 | 1        |            |               |
| PPM                                              |                 | 1        |            |               |

Net view | Site view

Summary | Bill Of Material x

151992



Table 2-31 describes the Site view subtab columns. See the “2.8.1 Viewing BoM Report Totals” section on page 2-131 for a description of the data, check boxes, and fields at the top of the window.

**Table 2-31 BoM Site View Columns**

| Column Label           | Description                                                                                                                                                                                                                                                                                                         |
|------------------------|---------------------------------------------------------------------------------------------------------------------------------------------------------------------------------------------------------------------------------------------------------------------------------------------------------------------|
| Name                   | Displays the site name. Click the plus (+) sign to expand the site and display the categories. Click the plus (+) sign to expand each category to view the items in the BoM.                                                                                                                                        |
| Product ID             | Displays the ordering code used to order the BoM from Cisco.                                                                                                                                                                                                                                                        |
| Quantity               | Displays the number of that specific item in the BoM.                                                                                                                                                                                                                                                               |
| Unit price             | Displays the price for each unit. If the price does not appear, Invalid will display. This occurs when the price list reports “NaN” (Not a Number) for the item because the price list has never been updated. Invalid items appear in the list in red. Items that have not been updated from CCO appear in yellow. |
| Unit Discount          | Displays the per-unit discount amount that you assigned in the Global Discount Percentage field. If you leave the field blank, the field displays the default value from the Price List database.                                                                                                                   |
| Total Price            | Displays the total price of the products before applying the discount.                                                                                                                                                                                                                                              |
| Discounted Total Price | Displays the total price of the products after applying the discount.                                                                                                                                                                                                                                               |

**Step 3** To close the Bill of Material report, click the **X** in the upper right corner of the Bill of Material tab.

## 2.8.4 Generating a Spare Parts Report

After you generate the BoM, use the following procedure to determine the spare parts required by the network. If the network is in the Upgrade state, the report includes the parts required to support the implemented services and the new additional present services. To generate a spare parts report, you must associate a site with a maintenance center before network analysis. For more information, see the “2.6.3 Editing Site Parameters” section on page 2-92.

**Step 1** Click the **Networks Mgmt Tree** tab and click the network.

**Step 2** In the Tasks Pane, click **Bill of Material**. Click the **Spare** subtab (Figure 2-77).



**Figure 2-77** Bill of Material Tab, Spare Subtab

Table 2-32 describes the Spare subtab columns. See the “2.8.1 Viewing BoM Report Totals” section on page 2-131 for a description of the data, check boxes, and fields at the top of the window.

**Table 2-32** BoM Spare Subtab Columns

| Column Label           | Description                                                                                                                                                                                                                                                                                                         |
|------------------------|---------------------------------------------------------------------------------------------------------------------------------------------------------------------------------------------------------------------------------------------------------------------------------------------------------------------|
| Name                   | Displays the name of the item at the site. Right-click the maintenance center and choose <b>Expand All</b> from the shortcut menu to view all spare parts.                                                                                                                                                          |
| Product ID             | Displays the ordering code used to order the BoM from Cisco.                                                                                                                                                                                                                                                        |
| Quantity               | Displays the number of specific items in the BoM.                                                                                                                                                                                                                                                                   |
| Unit price             | Displays the price for each unit. If the price does not appear, Invalid will display. This occurs when the price list reports “NaN” (Not a Number) for the item because the price list has never been updated. Invalid items appear in the list in red. Items that have not been updated from CCO appear in yellow. |
| Unit Discount          | Displays the per-unit discount amount that you assigned in the Global Discount Percentage field. If you leave the field blank, the field displays the default value from the Price List database.                                                                                                                   |
| Total Price            | Displays the total price of the parts before applying the discount.                                                                                                                                                                                                                                                 |
| Discounted Total Price | Displays the total price of the parts after applying the discount.                                                                                                                                                                                                                                                  |

- Step 3** To close the Bill of Material report, click the **X** in the upper right corner of the Bill of Material tab.
- 

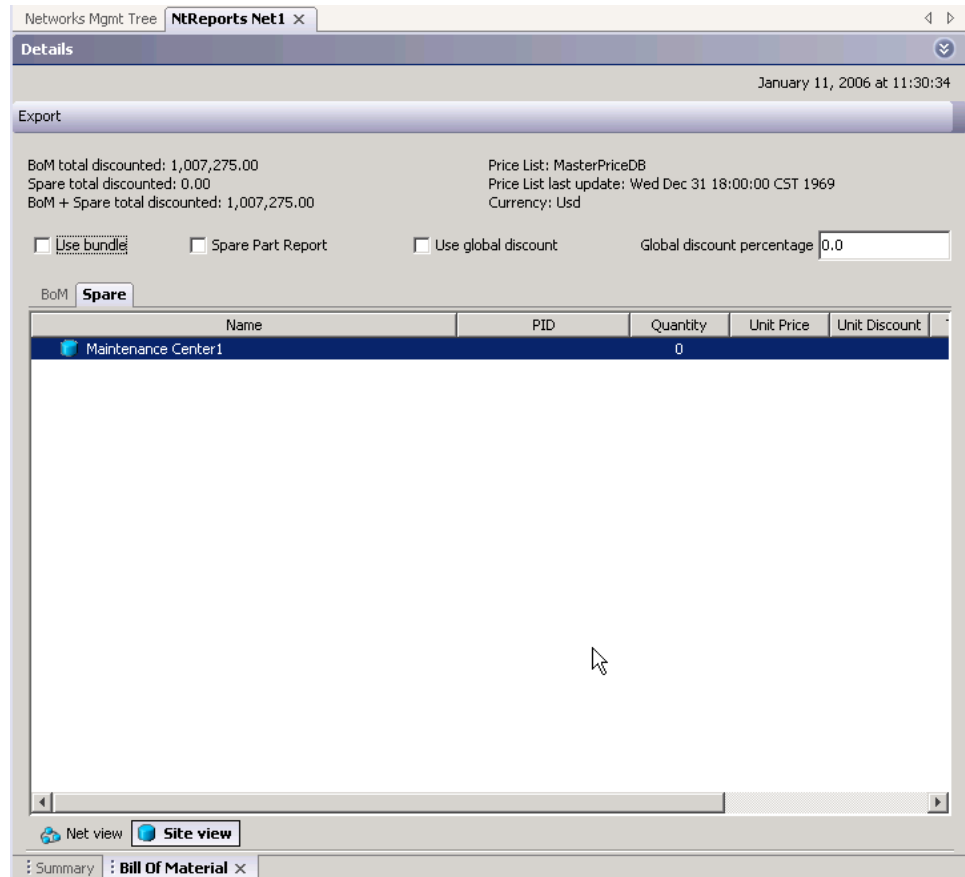
## 2.8.5 Exporting a BoM

Use the following procedure to export the BoM to an external file in XML, Excel spreadsheet, HTML, or text format:

- Step 1** Click the **Networks Mgmt Tree** tab and click the network.
- Step 2** In the Tasks Pane, click **Bill of Material**. The Bill of Material tab appears.
- Step 3** Click **Export**. The BoM export dialog box appears.
- Step 4** In the BoM export dialog box, type the name of the file, choose the file type (**.xls** and **.html**) from the drop-down list, and navigate to the desired folder. Click **Save**.
- 

## 2.9 Managing the Price List

A price list is defined for each project and is used to generate a BoM. Cisco TransportPlanner can manage multiple price lists. You can even change a project price list after a project has been established. The Master Price list is the Global Price List in US dollars. You can download new price lists from Cisco Connection Online (CCO).

Only the selected price value is saved with a project; the actual price database is not saved with the project. When opening a saved project (for example, a project received from another designer), the associated price database might not be available. If this is the case, Cisco TransportPlanner notifies you that the Master Price list will be used.

To save memory, Cisco TransportPlanner automatically loads only the price list selected for the current project.

### 2.9.1 Creating a New Price List

Use the following procedure to download a price list from CCO. You can download price lists from CCO if no projects are currently open.

- Step 1** If a project is open, close the project. See the [“2.1.5 Closing a Project”](#) section on page 2-18.
- Step 2** From the Tools menu, choose **Price List Mgmt**. The Price Manager dialog box appears ([Figure 2-78](#)).

Figure 2-78 Price Manager Dialog Box

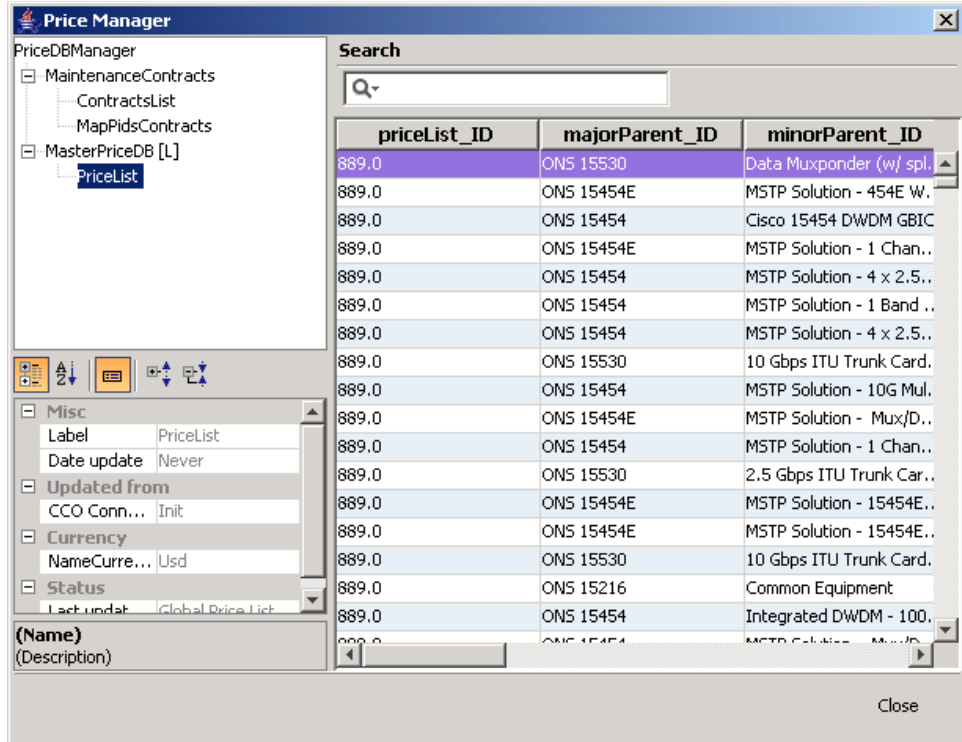

- Step 3** In the Price Manager dialog box, right click **PriceDBManager** and choose **New Price DB** from the shortcut menu.
- Step 4** In the Create a New Price DB dialog box, enter the price list name.
- Step 5** From the drop-down list, choose the desired CCO price list.
- Step 6** Click **OK**.
- Step 7** Click **OK** to update from CCO.
- Step 8** In the CCO User Name/Password dialog box, type your user name and password, and click **OK**. Cisco TransportPlanner downloads the CCO price list.
- Step 9** When the update is complete, click **OK** to close the confirmation dialog box. The new price list appears in the PriceDBManager tree.
- Step 10** Click **Close** to close the Price Manager dialog box.

## 2.9.2 Viewing a Price List

Use the following procedure to view and filter a price list:

- Step 1** From the Tools menu, choose **Price List Mgmt**. The Price Manager dialog box appears (Figure 2-78 on page 2-137).

The PriceDB Manager tree lists all of the created price lists. To save memory, Cisco TransportPlanner automatically loads only the price list selected for the current project (unless the user requests otherwise). An L indicates that the price list is loaded in memory and is available. A U indicates that a price list is currently not loaded in memory and is not available.

**Step 2** To load or unload a price list, right-click a price list and choose **Load** or **Unload** from the shortcut menu.

**Step 3** Click **PriceList** under the desired price list identifier in the PriceDBManager tree. The list displays in the right pane of the Price Manager dialog box. The properties of the price list appear in the bottom left corner of the Price Manager dialog box:

- Last update—Indicates the date of the last download from CCO for this price list. If Never appears, this indicates that the user created a price list without downloading from CCO.
- Updated by—Identifies the way in which the price list was updated.

The price list displays the following columns:

- Price List ID—For internal use.
- Major Parent ID—Lists the platform.
- Minor Parent ID—Lists the equipment type.
- Product ID—Identifies the ordering code for the specific unit.
- Description—Provides detail about the item.
- Service Category—For future use.
- List Price—Indicates the price of the item. If NaN (Not a Number) appears in the field, the list has not been updated.
- Major ID—For internal use.
- Minor ID— For internal use.
- Update Status—Identifies how the last update was made to an item:
  - None—Indicates that the price list has never been updated.
  - local\_file—Indicates that the price list has been updated from a local file.
  - cco—Indicates that the price list has been updated from CCO.
  - user—Indicates that the price list has been manually updated by the user who directly edited the price list. The user can modify the Discount field.
- Discount—If a discount applies, identifies the discount percentage. To modify this field, enter the new percentage.

**Step 4** To search for a specific item in a price list, type the desired item in the Search field at the top of the list. As you type, Cisco TransportPlanner filters the list items to match your search entry. To choose Search options, click the Search Tool icon to the left of the Search field and choose one of the following:

- Column name—Searches only the specified column for the search string. The All option searches all columns.
- Case sensitive—Matches the case of the search string.
- Case insensitive—Disregards the case of the search string.
- Match from start—Searches only for the search string if it appears at the beginning of column text.
- Match any where—Searches for the search string if it appears anywhere in the price list.

**Step 5** To sort the items in the price list, click on a column to sort by that column.

- Step 6** Click **Close** to close the Price Manager dialog box.
- 

## 2.9.3 Loading and Unloading Price Lists

To save memory, Cisco TransportPlanner automatically loads only the price list selected for the current project. An “L” by a price list in the Price Manager dialog box indicates that the price list is loaded; a “U” in the Price Manager dialog box indicates that the price list is not loaded. Use the following procedure to load or unload price lists in Cisco TransportPlanner:

- Step 1** From the Tools menu, choose **Price List Mgmt**. The Price Manager dialog box appears ([Figure 2-78 on page 2-137](#)).
- Step 2** Right-click the price list and choose **Load** or **Unload** from the shortcut menu.
- 

## 2.9.4 Updating a Price List from CCO

Use the following procedure to update a specified price list from CCO or from a local file. You can also update all price lists, even the lists that are not currently loaded. You can update a price lists from CCO if no projects are currently open.

- Step 1** If a project is open, close the project. See the “[2.1.5 Closing a Project](#)” section on page 2-18.
- Step 2** From the Tools menu, choose **Price List Mgmt**. The Price Manager dialog box appears ([Figure 2-78 on page 2-137](#)).
- Step 3** Right-click the desired price list identifier in the PriceDBManager tree and choose **Expand** from the shortcut menu.
- Step 4** Right-click the desired price list in the expanded tree and choose **UpdateFromCCO** from the shortcut menu.
- Step 5** In the Update from CCO dialog box, choose **Update single price list** to download data for the specified list or **Update all price lists** to download the latest data for all price lists.
- Step 6** In the CCO User Name/Password dialog box, type your user name and password and click **OK**. Cisco TransportPlanner downloads the price list.
- Step 7** When the update is complete, click **OK** to close the confirmation dialog box.
- Step 8** Click **Close** to close the Price Manager dialog box.
-

## 2.9.5 Copying a Price List

Use the following procedure to create a new price list by copying from an existing one. The new price list will have all of the attributes and values of the original price list (such as Updated By, Last Update, unit price, discounts, etc.). You can copy a price list if no projects are currently open.

- 
- Step 1** If a project is open, close the project. See the [“2.1.5 Closing a Project” section on page 2-18](#).
  - Step 2** From the Tools menu, choose **Price List Mgmt.** The Price Manager dialog box appears ([Figure 2-78 on page 2-137](#)).
  - Step 3** Right-click the desired price list in the PriceDBManager tree and choose **Copy** from the shortcut menu.
  - Step 4** Type the name for the new price list and click **Ok**. The new price list appears in the PriceDBManager tree.
  - Step 5** Click **Close** to close the Price Manager dialog box.
- 

## 2.9.6 Deleting a Price List

Use the following procedure to delete a price list. You cannot delete the Master Price List or a price list that is in use by a project. You can delete a price list if no projects are currently open.

- 
- Step 1** If a project is open, close the project. See the [“2.1.5 Closing a Project” section on page 2-18](#).
  - Step 2** From the Tools menu, choose **Price List Mgmt.** The Price Manager dialog box appears ([Figure 2-78 on page 2-137](#)).
  - Step 3** Right-click the desired price list in the PriceDBManager tree and choose **Delete** from the shortcut menu.
  - Step 4** Click **Close** to close the Price Manager dialog box.
- 

## 2.9.7 Viewing Maintenance Contracts

Use the following procedure to view maintenance contracts:

- 
- Step 1** From the Tools menu, choose **Price List Mgmt.** The Price Manager dialog box appears ([Figure 2-78 on page 2-137](#)).
  - Step 2** Right-click **Maintenance Contracts** and choose **Expand** from the shortcut menu.
  - Step 3** Click **ContractsList**. The Contract PID column lists the service contract identifiers for the hardware and software parts used by Cisco TransportPlanner. The Contract Category column describes the service programs.
  - Step 4** Click **MapPidsContracts**. The PID column lists the product identifiers. The Contracts column lists the service contract identifier.
  - Step 5** Click **Close** to close the Price Manager dialog box.
-



# CHAPTER 3

## Modeled Network Examples

---

This chapter provides examples of typical optical networks you can model using Cisco TransportPlanner.

This chapter contains the following sections:

[3.1 Supported Cisco TransportPlanner Topologies, page 3-1](#)

[3.2 Bus Topologies, page 3-1](#)

[3.3 Hubbed Ring Topology, page 3-2](#)

[3.4 Meshed Topology, page 3-3](#)

### 3.1 Supported Cisco TransportPlanner Topologies

Cisco TransportPlanner supports the following topologies:

- Bus (single span, point-to-point, and linear)
- Open (or hubbed) ring
- Closed (or meshed) ring

An example of each topology is given in this chapter.

### 3.2 Bus Topologies

Bus topologies comprise three types of topologies: single span, point-to-point, and linear.

#### 3.2.1 Single-Span Topology

[Figure 3-1](#) shows an example of a single-span topology. Single-span topologies are characterized by a single span link. The single-span configuration only supports two terminal sites (full terminal or flexible channel-count terminal) without any intermediate line amplifier or optical add/drop multiplexing (OADM) sites.

**Figure 3-1** *Single-Span Topology Example*

## 3.2.2 Point-to-Point Topology

Figure 3-2 shows an example of a point-to-point topology. In a point-to-point topology, all the wavelengths are terminated at the same point in the chain. In the point-to-point configuration, no channels are added or dropped in intermediate sites.

**Figure 3-2** *Point-to-Point Topology Example*

## 3.2.3 Linear Topology

Figure 3-3 shows an example of a linear topology. Linear configurations are characterized by the presence of two terminal sites (full terminal or flexible channel-count terminal). Between the two terminal sites, OADM or line amplifiers nodes can be inserted. In a linear configuration, specific wavelengths are terminated at different points in the chain and only unprotected traffic can be provisioned.

**Figure 3-3** *Linear Topology Example*

## 3.3 Hubbed Ring Topology

Figure 3-4 shows an example of a hubbed ring topology. In this configuration, at least one of the sites must be a hub site, where all channels are terminated.



**Figure 3-4 Hubbed Ring Topology Example**

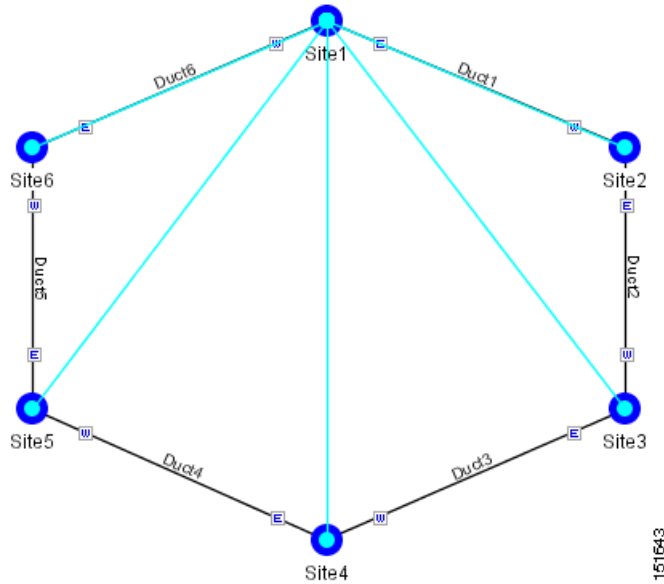

### 3.4 Meshed Topology

Figure 3-5 provides an example of a meshed ring topology. A meshed ring is characterized by the absence of a hub node.

**Figure 3-5 Meshed Ring Topology Example**

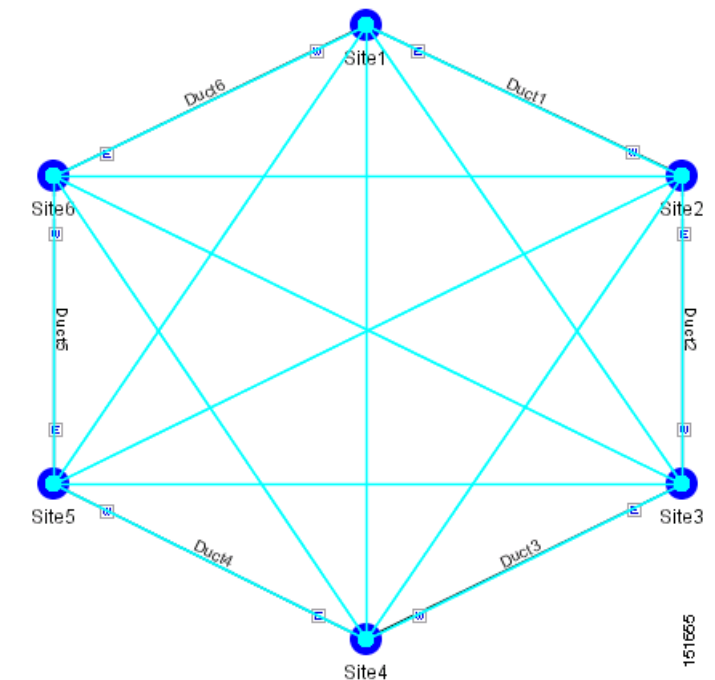





# APPENDIX A

## GUI Information and Shortcuts

This appendix describes the Cisco TransportPlanner views, menus, tools, and shortcuts options. For more information about Cisco TransportPlanner, refer to [Chapter 1, “Overview.”](#)

### Manage the Cisco TransportPlanner Window

The Cisco TransportPlanner window provides a menu bar, toolbar, a Project Explorer pane, a Properties pane, an Analyzer pane, and a Task Pane to allow you to manage a network design ([Figure A-1](#)). The Networks Mgmt Tree tab displays the networks that you have created for a project. The NtVw Net# tab displays the sites for a network (identified by the Net# on the tab).

**Figure A-1** Cisco TransportPlanner Window with Network Tree

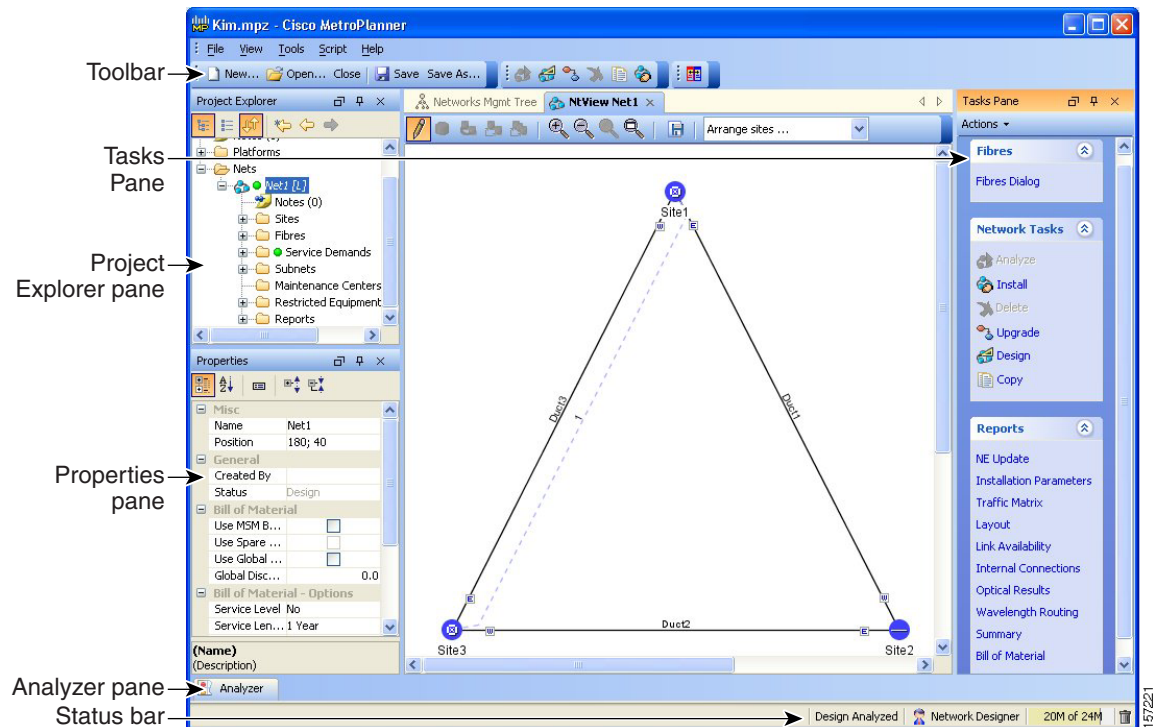

157221

## Menu and Toolbar Options

The Cisco TransportPlanner window menu bar and toolbar provide primary Cisco TransportPlanner functions. [Table A-1](#) shows the actions that are available from the menu and toolbar.

**Table A-1** *Menu and Toolbar Options*

| Menu | Menu Option        | Toolbar                                                                           | Description                                                                                                                                                                                                                                                      |
|------|--------------------|-----------------------------------------------------------------------------------|------------------------------------------------------------------------------------------------------------------------------------------------------------------------------------------------------------------------------------------------------------------|
| File | New                |  | Creates a new Cisco TransportPlanner project. See the <a href="#">“2.3 Creating a Project”</a> section on page 2-36.                                                                                                                                             |
|      | Open               |  | Opens an existing Cisco TransportPlanner project. See the <a href="#">“2.1.1 Opening a Project”</a> section on page 2-15.                                                                                                                                        |
|      | Close              |  | Closes the current project without closing the Cisco TransportPlanner session. If you have not saved the current project, Cisco TransportPlanner will prompt you to save before closing. See the <a href="#">“2.1.5 Closing a Project”</a> section on page 2-18. |
|      | Save               |  | Saves the current project. See the <a href="#">“2.1.3 Saving a Project”</a> section on page 2-16.                                                                                                                                                                |
|      | Save As            |  | Allows you to save the current project with a new file name. See the <a href="#">“2.1.3 Saving a Project”</a> section on page 2-16.                                                                                                                              |
|      | Import 2.5 Project | —                                                                                 | Allows you to import a Cisco TransportPlanner Release 2.5 project into Cisco TransportPlanner Release 7.0.1. See the <a href="#">“2.1.4 Importing a Cisco TransportPlanner Release 2.5 Project”</a> section on page 2-16.                                        |
|      | Clear History      | —                                                                                 | Clears the file history from Cisco TransportPlanner. Cisco TransportPlanner maintains a list of the last ten open projects in the File menu.                                                                                                                     |
|      | Exit               | —                                                                                 | Exits the Cisco TransportPlanner software.                                                                                                                                                                                                                       |









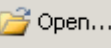
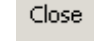
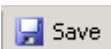
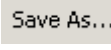

Table A-1 Menu and Toolbar Options (continued)

| Menu  | Menu Option       | Toolbar | Description                                                                                                                                                                                                                                                                                                                                                                                                                                                                                                                                                          |
|-------|-------------------|---------|----------------------------------------------------------------------------------------------------------------------------------------------------------------------------------------------------------------------------------------------------------------------------------------------------------------------------------------------------------------------------------------------------------------------------------------------------------------------------------------------------------------------------------------------------------------------|
| View  | My Default Layout | —       | Changes the Cisco TransportPlanner display to the user default layout. Cisco TransportPlanner allows you to define the default value for Platform Options, Project Options, and General Options. The defined value are used as default for each new created project. See the <a href="#">“2.2 Setting Cisco TransportPlanner Options”</a> section on page 2-18.                                                                                                                                                                                                      |
|       | Default Layout    | —       | Returns the Cisco TransportPlanner display to the system default layout.                                                                                                                                                                                                                                                                                                                                                                                                                                                                                             |
|       | Tasks Pane        | —       | Displays the commands available for the selected entity (network, site, duct, etc.).                                                                                                                                                                                                                                                                                                                                                                                                                                                                                 |
|       | Project Explorer  | —       | Displays the Project Explorer pane, which includes folders for project notes, networks, sites, fibers, traffic demand groups, subnets, maintenance centers, restricted equipment list, and reports. Clicking the plus (+) sign by each folder expands the folder. Clicking the minus (–) sign by each folder hides the folder contents. You can also right-click a folder and choose <b>Expand</b> from the shortcut menu to show folder contents. The default location of the Project Explorer pane is the upper left section of the Cisco TransportPlanner window. |
|       | Properties        | —       | Displays the Properties pane, which shows parameter settings for the selected entity in the Project Explorer, Networks Mgmt Tree tab, or NtVw Net# tab. The default location of the Properties pane is the lower left section of the Cisco TransportPlanner window.                                                                                                                                                                                                                                                                                                  |
|       | Analyzer Messages | —       | Displays the Analyzer Messages pane at the bottom of the Cisco TransportPlanner window. The Analyzer Messages pane displays any error messages that occur during network analysis.                                                                                                                                                                                                                                                                                                                                                                                   |
| Tools | Options           | —       | Opens the Options Explorer dialog box, where you can change the user default settings. See the <a href="#">“2.2 Setting Cisco TransportPlanner Options”</a> section on page 2-18.                                                                                                                                                                                                                                                                                                                                                                                    |
|       | DB Parts Mgmt     | —       | Opens the PartsTreePanel dialog box, where you can view the list of available parts for each release. See the <a href="#">“2.2.3 Setting the Default Project Values”</a> section on page 2-24.                                                                                                                                                                                                                                                                                                                                                                       |
|       | Price List Mgmt   | —       | Opens the Price Manager dialog box, where you can view maintenance contracts and add price databases. See the <a href="#">“2.9 Managing the Price List”</a> section on page 2-136.                                                                                                                                                                                                                                                                                                                                                                                   |
|       | Plug In           | —       | Opens the PlugIn Registry dialog box, which allows you to customize Cisco TransportPlanner with plug-ins released by Cisco. See the <a href="#">“2.2.8 Adding Plug-ins”</a> section on page 2-33 and the <a href="#">“2.2.9 Managing Plug-ins”</a> section on page 2-34.                                                                                                                                                                                                                                                                                             |
|       | Export            | —       | Opens the Export dialog box, which allows you to export user options, price lists, maintenance contracts, and parts database files. See the <a href="#">“2.2.5 Exporting a File”</a> section on page 2-30.                                                                                                                                                                                                                                                                                                                                                           |
|       | Import            | —       | Opens the Import dialog box, which allows you to import user options, price lists, maintenance contracts, and parts database files. See the <a href="#">“2.2.6 Importing a File”</a> section on page 2-31.                                                                                                                                                                                                                                                                                                                                                           |

Table A-1 Menu and Toolbar Options (continued)

| Menu   | Menu Option                             | Toolbar                                                                             | Description                                                                                                                                                                                                                                                                                                                   |
|--------|-----------------------------------------|-------------------------------------------------------------------------------------|-------------------------------------------------------------------------------------------------------------------------------------------------------------------------------------------------------------------------------------------------------------------------------------------------------------------------------|
| Script | Run Script                              | —                                                                                   | Opens the Choose a script to run dialog box, which allows you to run a script that Cisco provides. See the “ <a href="#">2.2.11 Running a Script</a> ” section on page 2-35.                                                                                                                                                  |
|        | Run Again                               | —                                                                                   | Runs the script that was last used.                                                                                                                                                                                                                                                                                           |
|        | Common                                  | —                                                                                   | Displays any scripts in the scripts directory where Cisco TransportPlanner is installed.                                                                                                                                                                                                                                      |
|        | User                                    | —                                                                                   | Displays any scripts in the C:/Documents And Settings/<user-home>/MP_<version>/scripts directory.                                                                                                                                                                                                                             |
|        | Refresh Dirs                            | —                                                                                   | Refreshes the Script menu. This command removes script names from the Run Again menu, and updates the Script > Common and User menus. See the “ <a href="#">2.2.12 Refreshing the Script Menu</a> ” section on page 2-35.                                                                                                     |
| Help   | Manual                                  | —                                                                                   | Opens the Cisco TransportPlanner online help.                                                                                                                                                                                                                                                                                 |
|        | Tips Of The Day                         | —                                                                                   | Opens the Tip of the Day dialog box, which provides helpful hints about using Cisco TransportPlanner. Click the <b>Next</b> button to view the next tip and the <b>Back</b> button to view a previous tip. Check <b>Show Tips on Startup</b> to display the Tip of the Day dialog box when you launch Cisco TransportPlanner. |
|        | About                                   | —                                                                                   | Displays Cisco TransportPlanner version information.                                                                                                                                                                                                                                                                          |
| —      | Create a new site                       |    | Opens the Site Creation wizard when you click this icon and then click in the Cisco TransportPlanner window. See the “ <a href="#">2.3.1 Adding Sites</a> ” section on page 2-45.                                                                                                                                             |
| —      | Create a new duct                       |  | Allows you to create a new duct between sites. See the “ <a href="#">2.3.2 Adding Fiber Spans</a> ” section on page 2-46.                                                                                                                                                                                                     |
| —      | Create a new P2P demand                 |  | Opens the Point to Point Demand Creation Wizard when you click this icon and then click two sites. See the “ <a href="#">2.3.4 Creating a Point-to-Point Demand</a> ” section on page 2-48.                                                                                                                                   |
| —      | Create a new P-ring demand              |  | Opens the P-Ring Creation Wizard. See the “ <a href="#">2.3.5 Creating a Protected Ring Demand</a> ” section on page 2-50.                                                                                                                                                                                                    |
| —      | Create a new TDM Aggregated demand      |  | Opens a TDM creation wizard. See the <a href="#">2.3.8 Creating TDM Aggregated Demand</a> , page 2-57                                                                                                                                                                                                                         |
| —      | Create a new Ethernet Aggregated demand |  | Opens a Ethernet creation wizard. See the <a href="#">2.3.7 Creating Ethernet Aggregated Demand</a> , page 2-55                                                                                                                                                                                                               |
| —      | Zoom in                                 |  | Zooms in on the NtVw Net# tab.                                                                                                                                                                                                                                                                                                |
| —      | Zoom out                                |  | Zoom out from the NtVw Net# tab.                                                                                                                                                                                                                                                                                              |

Table A-1 Menu and Toolbar Options (continued)

| Menu | Menu Option                         | Toolbar                                                                             | Description                                                                                                                                                                 |
|------|-------------------------------------|-------------------------------------------------------------------------------------|-----------------------------------------------------------------------------------------------------------------------------------------------------------------------------|
| —    | Normal viewing                      |    | Returns the NtVw Net# tab to normal viewing (1:1).                                                                                                                          |
| —    | Fit to window                       |    | Resizes the view so that all sites fit inside the NtVw Net# tab window.                                                                                                     |
| —    | Save network view image             |    | Saves a JPEG of the network design. See the <a href="#">“2.7.5 Creating a JPEG of the Network Design”</a> section on page 2-130.                                            |
| —    | Analyze Network                     |    | Analyzes the selected network. See the <a href="#">“2.4 Analyzing the Network”</a> section on page 2-62.                                                                    |
| —    | Enter design mode                   |    | Puts the selected Design-Analyzed network back into the design mode for further changes. See the <a href="#">“2.4 Analyzing the Network”</a> section on page 2-62.          |
| —    | Put current network in upgrade mode |    | Creates a copy of the selected Design-Analyzed network in the Upgrade state. See the <a href="#">“2.7.3 Creating an Upgrade Network”</a> section on page 2-128.             |
| —    | Delete current network              |  | Deletes the selected network. See the <a href="#">“2.6.12 Deleting a Network”</a> section on page 2-112.                                                                    |
| —    | Copy current network                |  | Copies the selected network. See the <a href="#">“2.7.1 Creating a Copy of the Network”</a> section on page 2-127.                                                          |
| —    | Put current network in install mode |  | Creates a copy of the selected Design-Analyzed network in the Install state. See the <a href="#">“2.7.2 Creating a Network in the Install State”</a> section on page 2-127. |
| —    | Reports Diff                        |  | Opens the Reports Diff dialog box, which allows you to create a report that shows the differences between networks.                                                         |
| —    | Run the Garbage Collector           |  | Deletes unloaded networks from memory.                                                                                                                                      |

## Cisco TransportPlanner Panes











Cisco TransportPlanner provides four panes that help you manage a network design: Project Explorer, Properties, Analysis, and Tasks Pane.

## Project Explorer Pane

The Project Explorer pane provides a management tree for the entire project. Each network appears as a folder that contains the sites, fibers, traffic groups, subnets, maintenance centers, restricted equipment lists, and reports for that network. If you have made changes to a network design, that network folder and the changed item folder appear in blue italics in the pane.

By default, the Project Explorer pane is located in the upper left section of the Cisco TransportPlanner window. [Table A-2](#) shows the actions that are available from the Project Explorer toolbar.

**Table A-2** Project Explorer Toolbar Options

| Toolbar                                                                             | Description                                                                                                                                                                                                                                                                                     |
|-------------------------------------------------------------------------------------|-------------------------------------------------------------------------------------------------------------------------------------------------------------------------------------------------------------------------------------------------------------------------------------------------|
|    | Displays the Project Explorer as a single pane.                                                                                                                                                                                                                                                 |
|    | Displays the Project Explorer as split panes. The upper pane contains the main project tree; the lower pane shows only the folders for the network that is selected in the upper pane.                                                                                                          |
|    | Auto scrolls to the selected object in the Project Explorer tree. For example, if you click on a site in the NtView Net# tab but it is not in view in the Project Explorer tree, Cisco TransportPlanner will automatically scroll the Project Explorer pane until the selected site is in view. |
|  | Moves backward through the list of previously selected items in the Project Explorer.                                                                                                                                                                                                           |
|  | Moves forward through the list of previously selected items in the Project Explorer.                                                                                                                                                                                                            |
|  | Moves (undocks) the Project Explorer pane from the default location in the upper left corner so that you can move it around your desktop area as an individual window.                                                                                                                          |
|  | Moves the Project Explorer back to the default location.                                                                                                                                                                                                                                        |
|  | Hides the Project Explorer. To view again, move the mouse over the Prop tab that appears in the upper left corner of the Cisco TransportPlanner window.                                                                                                                                         |
|  | When in hidden mode, reopens the Project Explorer in the default location.                                                                                                                                                                                                                      |
|  | Closes the Project Explorer pane. To reopen, choose <b>Project Explorer</b> from the View menu.                                                                                                                                                                                                 |











## Properties Pane

The Properties pane shows all of the parameters set for a selected item (either in the Project Explorer, the Network Mgmt Tree tab, or the NtVw Net# tab). Many items are editable in the Properties pane. By default, the Properties pane is located in the lower left section of the Cisco TransportPlanner window.



Table A-3 shows the actions that are available from the Properties Pane toolbar.











**Table A-3 Properties Pane Toolbar Options**

| Toolbar                                                                             | Description                                                                                                                                                      |
|-------------------------------------------------------------------------------------|------------------------------------------------------------------------------------------------------------------------------------------------------------------|
|    | Categorizes the properties by type.                                                                                                                              |
|    | Organizes the properties in alphabetical order.                                                                                                                  |
|    | Shows or hides the description area at the bottom of the Properties pane.                                                                                        |
|    | Expands the property categories (if collapsed).                                                                                                                  |
|    | Collapses the property categories (if expanded).                                                                                                                 |
|    | Moves (undocks) the Properties pane from the default location in the lower left corner so that you can move it around your desktop area as an individual window. |
|  | Moves the Properties pane back to the default location.                                                                                                          |
|  | Hides the Property pane. To view again, move the mouse over the Prop tab that appears in the upper left corner of the Cisco TransportPlanner window.             |
|  | When in hidden mode, reopens the Properties pane so that it appears in the default location.                                                                     |
|  | Closes the Properties Pane. To reopen, choose <b>Properties</b> from the View menu.                                                                              |

## Analyzer Pane

The Analyzer tab at the bottom of the Cisco TransportPlanner window appears after you have analyzed a network design. Clicking the Analyzer tab opens the Analyzer pane. Table A-5 shows the actions that are available from the Analyzer pane.



**Table A-4 Analyzer Toolbar Options**

| Toolbar                                                                             | Description                                                                                                                                                    |
|-------------------------------------------------------------------------------------|----------------------------------------------------------------------------------------------------------------------------------------------------------------|
|    | Moves down through the Analyzer messages.                                                                                                                      |
|    | Moves up through the Analyzer messages.                                                                                                                        |
|    | Opens the Apply Filters dialog box, which allows you to filter the messages to show or hide Exceptions, Errors, Warnings, and/or Info.                         |
|    | Expands the Analyzer message categories (if collapsed).                                                                                                        |
|    | Collapses the Analyzer message categories (if expanded).                                                                                                       |
|    | Moves (undocks) the Analyzer pane from the default location in the lower left corner so that you can move it around your desktop area as an individual window. |
|    | Moves the Analyzer pane back to the default location.                                                                                                          |
|  | Hides the Analyzer pane. To view again, move the mouse over the Analyzer tab that appears in the bottom of the Cisco TransportPlanner window.                  |
|  | Opens the Analyzer pane so that it remains open in the bottom section of the Cisco TransportPlanner window.                                                    |
|  | Closes the Analyzer pane. To reopen, choose <b>Analyzer messages</b> from the View menu.                                                                       |



## Tasks Pane

The Tasks Pane lists the available commands and reports for a selected item. The commands change based on the selected item. For example, a selected site will have different commands available than a selected fiber span. By default, the Tasks Pane is located in the upper right section of the Cisco TransportPlanner window. [Table A-5](#) shows the actions that are available from the Tasks Pane toolbar.

**Table A-5 Tasks Pane Toolbar Options**

| Toolbar                                                                             | Description                                                                                                                                                 |
|-------------------------------------------------------------------------------------|-------------------------------------------------------------------------------------------------------------------------------------------------------------|
|  | Moves (undocks) the Tasks Pane from the default location in the lower left corner so that you can move it around your desktop area as an individual window. |
|  | Moves the Tasks Pane back to the default location.                                                                                                          |

**Table A-5** *Tasks Pane Toolbar Options (continued)*

| Toolbar                                                                           | Description                                                                                                                                         |
|-----------------------------------------------------------------------------------|-----------------------------------------------------------------------------------------------------------------------------------------------------|
|  | Hides the Tasks Pane. To view again, move the mouse over the Tasks tab that appears in the upper right corner of the Cisco TransportPlanner window. |
|  | When in hidden mode, reopens the Tasks Pane so that it appears in the default location.                                                             |
|  | Closes the Tasks Pane. To reopen, choose <b>Tasks Pane</b> from the View menu.                                                                      |

## Shortcuts

Cisco TransportPlanner provides the following mouse shortcuts:

- Double-clicking a network icon in the Network Mgmt Tree tab opens the NtVw Net# tab, which shows the sites for that network.
- Right-clicking a report table column displays a shortcut menu that allows you to view or hide the columns in a report.
- Right-clicking an item in the Network Mgmt Tree tab or NtVw Net# tabs opens a shortcut menu that allows you to choose actions to perform on the selected item. The shortcut menu options differ based on the item selected and the network state. (Many commands are not available until a network is analyzed.) [Table A-6](#) lists the shortcut menu actions that are available for each item.

Table A-6 Shortcut Menu Actions

| Item                                                           | Available Shortcut Actions                                                                                                                                                                                                                                                                                                                                                                                                                                                                                                                                                                                                                                                                                                                                                                                                                                                                                                                                                                                                                                                                                                                                                                                                                                                                                                                                                                                                                                                                                                                                                                                                                                                                                                                                                                                                                                                                                                                                                                                                                                                                                                                                                                                                                                                          |
|----------------------------------------------------------------|-------------------------------------------------------------------------------------------------------------------------------------------------------------------------------------------------------------------------------------------------------------------------------------------------------------------------------------------------------------------------------------------------------------------------------------------------------------------------------------------------------------------------------------------------------------------------------------------------------------------------------------------------------------------------------------------------------------------------------------------------------------------------------------------------------------------------------------------------------------------------------------------------------------------------------------------------------------------------------------------------------------------------------------------------------------------------------------------------------------------------------------------------------------------------------------------------------------------------------------------------------------------------------------------------------------------------------------------------------------------------------------------------------------------------------------------------------------------------------------------------------------------------------------------------------------------------------------------------------------------------------------------------------------------------------------------------------------------------------------------------------------------------------------------------------------------------------------------------------------------------------------------------------------------------------------------------------------------------------------------------------------------------------------------------------------------------------------------------------------------------------------------------------------------------------------------------------------------------------------------------------------------------------------|
| Networks in the following states: Design, Install, and Upgrade | <ul style="list-style-type: none"> <li>• Unload/Load—Unloads or loads the network. See the “<a href="#">2.1.2 Loading and Unloading Networks</a>” section on page 2-15.</li> <li>• Edit Note—Allows you to create a note for the network. See the “<a href="#">2.3.9 Adding Notes to a Project</a>” section on page 2-60.</li> <li>• Delete—Removes the network from the project. See the “<a href="#">2.6.12 Deleting a Network</a>” section on page 2-112.</li> <li>• Copy—Creates a copy of the network. See the “<a href="#">2.7.1 Creating a Copy of the Network</a>” section on page 2-127.</li> <li>• Arrange Sites—Allows you to rearrange sites in the Cisco TransportPlanner window. See the “<a href="#">2.6.22 Arranging Sites</a>” section on page 2-122.</li> </ul>                                                                                                                                                                                                                                                                                                                                                                                                                                                                                                                                                                                                                                                                                                                                                                                                                                                                                                                                                                                                                                                                                                                                                                                                                                                                                                                                                                                                                                                                                                   |
| Analyzed networks                                              | <ul style="list-style-type: none"> <li>• Unload/Load—Unloads or loads the network. See the “<a href="#">2.1.2 Loading and Unloading Networks</a>” section on page 2-15.</li> <li>• Edit Note—Allows you to create a note for that item. See the “<a href="#">2.3.9 Adding Notes to a Project</a>” section on page 2-60.</li> <li>• Install—Creates a copy of the network in the Install state. See the “<a href="#">2.7.2 Creating a Network in the Install State</a>” section on page 2-127.</li> <li>• Delete—Removes the network from the project. See the “<a href="#">2.6.12 Deleting a Network</a>” section on page 2-112.</li> <li>• Upgrade—Creates a copy of the network in the Upgrade state. See the “<a href="#">2.7.3 Creating an Upgrade Network</a>” section on page 2-128.</li> <li>• Copy—Creates a copy of the network. See the “<a href="#">2.7.1 Creating a Copy of the Network</a>” section on page 2-127.</li> <li>• Layout—Opens the Layout tab. See the “<a href="#">2.5.6 Displaying the Layout</a>” section on page 2-74.</li> <li>• Internal Connections—Opens the Internal Connections tab. See the “<a href="#">2.5.4 Viewing Internal Connections</a>” section on page 2-68.</li> <li>• Optical Results—Opens the Optical Results tab. See the “<a href="#">2.5.9 Viewing Optical Results</a>” section on page 2-79.</li> <li>• Wavelength Routing—Opens the Wavelength Routing tab. See the “<a href="#">2.5.10 Viewing Wavelength Routing</a>” section on page 2-83.</li> <li>• Bill of Material—Opens the Bill of Materials tab. See the “<a href="#">2.8.2 Generating a Network BoM</a>” section on page 2-132.</li> <li>• Installation—Opens a submenu with the following options: <ul style="list-style-type: none"> <li>– NE Update—Creates a configuration file for each site in the network. See the “<a href="#">2.5.2 Saving the NE Update File</a>” section on page 2-65.</li> <li>– Installation Parameters—Opens the Installation Parameters tab. See the “<a href="#">2.5.3 Viewing the Installation Parameters</a>” section on page 2-66.</li> </ul> </li> <li>• Arrange Sites—Allows you to rearrange sites in the Cisco TransportPlanner window. See the “<a href="#">2.6.22 Arranging Sites</a>” section on page 2-122.</li> </ul> |







**Table A-6** *Shortcut Menu Actions (continued)*

| Item            | Available Shortcut Actions                                                                                                                                                                                                                                                                                                                                                                                                                                                                                                                                                                                                                                                                                                                                                                                                                                                                                                                                                                                                                                                                                                                                                                                                                                                                                                                                                                                                                                                                                                                                                                                                                                                                                                                           |
|-----------------|------------------------------------------------------------------------------------------------------------------------------------------------------------------------------------------------------------------------------------------------------------------------------------------------------------------------------------------------------------------------------------------------------------------------------------------------------------------------------------------------------------------------------------------------------------------------------------------------------------------------------------------------------------------------------------------------------------------------------------------------------------------------------------------------------------------------------------------------------------------------------------------------------------------------------------------------------------------------------------------------------------------------------------------------------------------------------------------------------------------------------------------------------------------------------------------------------------------------------------------------------------------------------------------------------------------------------------------------------------------------------------------------------------------------------------------------------------------------------------------------------------------------------------------------------------------------------------------------------------------------------------------------------------------------------------------------------------------------------------------------------|
| Sites           | <ul style="list-style-type: none"> <li>• Edit Note—Allows you to create a note for that item. See the <a href="#">“2.3.9 Adding Notes to a Project”</a> section on page 2-60.</li> <li>• Delete—Removes the site from the project. See the <a href="#">“2.6.14 Deleting Sites”</a> section on page 2-113.</li> </ul> <p>If the network is analyzed, the following actions are also available:</p> <ul style="list-style-type: none"> <li>• Layout—Opens the Layout tab. See the <a href="#">“2.5.6 Displaying the Layout”</a> section on page 2-74.</li> <li>• Internal Connections—Opens the Internal Connections tab. See the <a href="#">“2.5.4 Viewing Internal Connections”</a> section on page 2-68.</li> <li>• Optical Results—Opens the Optical Results tab. See the <a href="#">“2.5.9 Viewing Optical Results”</a> section on page 2-79.</li> <li>• Wavelength Routing—Opens the Wavelength Routing tab. See the <a href="#">“2.5.10 Viewing Wavelength Routing”</a> section on page 2-83.</li> <li>• Bill of Material—Opens the Bill of Materials tab. See the <a href="#">“2.8.2 Generating a Network BoM”</a> section on page 2-132.</li> <li>• Installation—Opens a submenu with the following options: <ul style="list-style-type: none"> <li>– NE Update—Creates a configuration file for each site in the network. See the <a href="#">“2.5.2 Saving the NE Update File”</a> section on page 2-65.</li> <li>– Installation Parameters—Opens the Installation Parameters tab. See the <a href="#">“2.5.3 Viewing the Installation Parameters”</a> section on page 2-66.</li> </ul> </li> <li>• Unlock—Unlocks the site. See the <a href="#">“2.7.4 Unlocking Parameters in the Network Design”</a> section on page 2-129.</li> </ul> |
| Fiber spans     | <ul style="list-style-type: none"> <li>• Edit Note—Allows you to create a note for that item. See the <a href="#">“2.3.9 Adding Notes to a Project”</a> section on page 2-60.</li> </ul> <p>If the network is analyzed, the Unlock command is also available. See the <a href="#">“2.7.4 Unlocking Parameters in the Network Design”</a> section on page 2-129.</p>                                                                                                                                                                                                                                                                                                                                                                                                                                                                                                                                                                                                                                                                                                                                                                                                                                                                                                                                                                                                                                                                                                                                                                                                                                                                                                                                                                                  |
| Traffic demands | <ul style="list-style-type: none"> <li>• Edit Note—Allows you to create a note for that item. See the <a href="#">“2.3.9 Adding Notes to a Project”</a> section on page 2-60.</li> <li>• Edit—Allows you to edit the demand. See the <a href="#">“2.6.6 Editing a Point-to-Point Demand”</a> section on page 2-100, <a href="#">“2.6.7 Editing a P-Ring Demand”</a> section on page 2-101, or <a href="#">“2.6.8 Editing a ROADM Demand”</a> section on page 2-102.</li> <li>• Delete—Removes the demand from the project. See the <a href="#">“2.6.15 Deleting a Traffic Demand”</a> section on page 2-113.</li> </ul> <p>If the network is analyzed, the Unlock command is also available. See the <a href="#">“2.7.4 Unlocking Parameters in the Network Design”</a> section on page 2-129.</p>                                                                                                                                                                                                                                                                                                                                                                                                                                                                                                                                                                                                                                                                                                                                                                                                                                                                                                                                                   |

## Site Icons

A site icon indicates the functionality of site. [Table A-7](#) lists the site icons.

Table A-7 Site Icons

| Site Name      | Site Icon                                                                           | Description                                                                                                                                                                                                                                                                                                                                                                                                                                                                                                                           |
|----------------|-------------------------------------------------------------------------------------|---------------------------------------------------------------------------------------------------------------------------------------------------------------------------------------------------------------------------------------------------------------------------------------------------------------------------------------------------------------------------------------------------------------------------------------------------------------------------------------------------------------------------------------|
| Add/Drop       |    | Indicates that this site has add/drop capability. Only point-to-point and P-ring circuits can be added/dropped at this site.                                                                                                                                                                                                                                                                                                                                                                                                          |
| Gain equalizer |    | Indicates that this site uses wavelength selective switch cards to control the generated tilt and extend unregenerated distances. The site is realized as an ROADM site without demultiplexer cards.                                                                                                                                                                                                                                                                                                                                  |
| Hub            |    | Indicates that this site is equipped with filters for adding and dropping all the channels (on both West and East sides). All express paths are open in hub configurations.                                                                                                                                                                                                                                                                                                                                                           |
| Line amplifier |    | Indicates that any add/drop traffic is prevented at this site.                                                                                                                                                                                                                                                                                                                                                                                                                                                                        |
| OSC site       |    | Indicates that site is designated for network communication, providing the possibility to access the optical service channel (OSC) for management of the MultiService Transport platform (MSTP) network. By default, no amplifiers are included in this site. However, if Cisco TransportPlanner determines that an amplifier is required in the network, it can automatically place it at this location. Cisco TransportPlanner allows you to set (force) preamplifier and booster amplifiers for each direction on a OSC Site node. |
| Pass Through   |  | Indicates that no equipment will be located at this site.                                                                                                                                                                                                                                                                                                                                                                                                                                                                             |
| R-ROADM        |  | Indicates that this site supports Any-to-Any and also Fixed (point-to-point and P-ring) traffic types.                                                                                                                                                                                                                                                                                                                                                                                                                                |



# APPENDIX **B**

## Card Types

This appendix provides a list of interface and card types supported in Cisco TransportPlanner, as well as the corresponding Cisco product ID (Tables B-1 to B-29).



**Note**

The card names in this appendix designated with “\_C” or “\_L” appear in Cisco TransportPlanner with a “\_y” designation before network analysis. The “\_y” designation indicates that Cisco TransportPlanner will use either a C- or L-band card, depending on the band selected during project creation.

**Table B-1 OC-192/STM-64 (9.953 Gbps)**

| Interface Type | Card Type                                            | Protection Type | Product ID                  |
|----------------|------------------------------------------------------|-----------------|-----------------------------|
| Transponder    | TXP_MR_10E_C and TXP_MR_10E_L with EFEC <sup>1</sup> | Client 1+1      | 15454-10E-L1-C= (C band)    |
|                |                                                      | Y-Cable         | 15454-10E-L1-L= (L band)    |
| Transponder    | TXP_MR_10E_C and TXP_MR_10E_L with FEC <sup>2</sup>  | Client 1+1      | 15454-10E-L1-C= (C band)    |
|                |                                                      | Y-Cable         | 15454-10E-L1-L= (L band)    |
| Transponder    | TXP_MR_10E_C and TXP_MR_10E_L without FEC            | Client 1+1      | 15454-10E-L1-C= (C band)    |
|                |                                                      | Y-Cable         | 15454-10E-L1-L= (L band)    |
| Transponder    | TXP_MR_10E with EFEC                                 | Client 1+1      | 15454-10E-L1-xx.y= (C band) |
|                |                                                      | Y-Cable         | 15454-10E-L1-xx.y= (L band) |
| Transponder    | TXP_MR_10E with FEC                                  | Client 1+1      | 15454-10E-L1-xx.y= (C band) |
|                |                                                      | Y-Cable         | 15454-10E-L1-xx.y= (L band) |
| Transponder    | TXP_MR_10E without FEC                               | Client 1+1      | 15454-10E-L1-xx.y= (C band) |
|                |                                                      | Y-Cable         | 15454-10E-L1-xx.y= (L band) |
| Transponder    | TXP_MR_10G with FEC                                  | Client 1+1      | 15454-10T-L1-xx.y=          |
|                |                                                      | Y-Cable         |                             |
| Transponder    | TXP_MR_10G without FEC                               | Client 1+1      | 15454-10T-L1-xx.y=          |
|                |                                                      | Y-Cable         |                             |
| Line Card      | OC-192 LR                                            | Client 1+1      | 15454-192L-1-xx.y= (ANSI)   |
|                | STM-64 LR                                            |                 | 15454E-64L-xx.y= (ETSI)     |

1. Enhanced forward error correction.
2. Forward error correction.

**Table B-2 OC-48/STM-16 (2.488 Gbps)**

| Interface Type | Card Type                                 | Protection Type | Product ID                 |
|----------------|-------------------------------------------|-----------------|----------------------------|
| Transponder    | TXP_MR_2.5G                               | Client 1+1      | 15454-MR-L1-xx.y= (Unprot) |
|                | TXPP_MR_2.5G with FEC                     | Y-Cable         | 15454-MRP-L1-xx.y= (Prot)  |
|                |                                           | Fiber-Switched  |                            |
| Transponder    | TXP_MR_2.5G                               | Client 1+1      | 15454-MR-L1-xx.y= (Unprot) |
|                | TXPP_MR_2.5G without FEC                  | Y-Cable         | 15454-MRP-L1-xx.y= (Prot)  |
|                |                                           | Fiber-Switched  |                            |
| Transponder    | MXP_2.5_10E_C and MXP_2.5_10E_L with EFEC | Client 1+1      | 15454-10ME-L1-C= (C band)  |
|                |                                           | Y-Cable         | 15454-10ME-L1-L= (L band)  |
| Transponder    | MXP_2.5_10E_C and MXP_2.5_10E_L with FEC  | Client 1+1      | 15454-10ME-L1-C= (C band)  |
|                |                                           | Y-Cable         | 15454-10ME-L1-L= (L band)  |
| Transponder    | MXP_2.5_10E with EFEC                     | Client 1+1      | 15454-10ME-xx.y=           |
|                |                                           | Y-Cable         |                            |
| Transponder    | MXP_2.5_10ET with FEC                     | Client 1+1      | 15454-10ME-xx.y=           |
|                |                                           | Y-Cable         |                            |
| Transponder    | MXP_2.5_10G with FEC                      | Client 1+1      | 15454-10M-L1-xx.y=         |
|                |                                           | Y-Cable         |                            |
| Transponder    | MXP_2.5_10G without FEC                   | Client 1+1      | 15454-10M-L1-xx.y=         |
|                |                                           | Y-Cable         |                            |
| Line Card      | OC48ELR / SMT-16ELR                       | Client 1+1      | 15454-O48E-1-xx.y (ANSI)   |
|                |                                           |                 | 15454E-EL16HSxxyy= (ETSI)  |
| Transponder    | ADM-10G                                   | Client 1+1      | 15454-ADM-10G = (Unprot)   |
|                |                                           | Y-Cable         | 15454-ADM-10G = (Prot)     |
|                |                                           | Fiber-Switched  |                            |



**Table B-3 OC-12/STM-4 (622 Mbps)**

| Interface Type | Card Type                               | Protection Type | Product ID                 |
|----------------|-----------------------------------------|-----------------|----------------------------|
| Transponder    | TXP_MR_2.5G<br>TXPP_MR_2.5G with FEC    | Client 1+1      | 15454-MR-L1-xx.y= (Unprot) |
|                |                                         | Y-Cable         | 15454-MRP-L1-xx.y= (Prot)  |
|                |                                         | Fiber-Switched  |                            |
| Transponder    | TXP_MR_2.5G<br>TXPP_MR_2.5G without FEC | Client 1+1      | 15454-MR-L1-xx.y= (Unprot) |
|                |                                         | Y-Cable         | 15454-MRP-L1-xx.y= (Prot)  |
|                |                                         | Fiber-Switched  |                            |
| Transponder    | ADM-10G                                 | Client 1+1      | 15454-ADM-10G = (Unprot)   |
|                |                                         | Y-Cable         | 15454-ADM-10G = (Prot)     |
|                |                                         | Fiber-Switched  |                            |

**Table B-4 OC-3/STM-1 (155 Mbps)**

| Interface Type | Card Type                               | Protection Type | Product ID                 |
|----------------|-----------------------------------------|-----------------|----------------------------|
| Transponder    | TXP_MR_2.5G<br>TXPP_MR_2.5G with FEC    | Client 1+1      | 15454-MR-L1-xx.y= (Unprot) |
|                |                                         | Y-Cable         | 15454-MRP-L1-xx.y= (Prot)  |
|                |                                         | Fiber-Switched  |                            |
| Transponder    | TXP_MR_2.5G<br>TXPP_MR_2.5G without FEC | Client 1+1      | 15454-MR-L1-xx.y= (Unprot) |
|                |                                         | Y-Cable         | 15454-MRP-L1-xx.y= (Prot)  |
|                |                                         | Fiber-Switched  |                            |
| Transponder    | ADM-10G                                 | Client 1+1      | 15454-ADM-10G = (Unprot)   |
|                |                                         | Y-Cable         | 15454-ADM-10G = (Prot)     |
|                |                                         | Fiber-Switched  |                            |

**Table B-5 10 Gigabit Ethernet Wide Area Network ATM Physical Layer (10GE WAN PHY) (9.953 Gbps)**

| Interface Type | Card Type                                       | Protection Type | Product ID               |
|----------------|-------------------------------------------------|-----------------|--------------------------|
| Transponder    | TXP_MR_10E_C and<br>TXP_MR_10E_L with<br>EFEC   | Client 1+1      | 15454-10E-L1-C= (C band) |
|                |                                                 | Y-Cable         | 15454-10E-L1-L= (L band) |
| Transponder    | TXP_MR_10E_C and<br>TXP_MR_10E_L with FEC       | Client 1+1      | 15454-10E-L1-C= (C band) |
|                |                                                 | Y-Cable         | 15454-10E-L1-L= (L band) |
| Transponder    | TXP_MR_10E_C and<br>TXP_MR_10E_L without<br>FEC | Client 1+1      | 15454-10E-L1-C= (C band) |
|                |                                                 | Y-Cable         | 15454-10E-L1-L= (L band) |
| Transponder    | TXP_MR_10E with EFEC                            | Client 1+1      | 15454-10E-L1-C= (C band) |
|                |                                                 | Y-Cable         | 15454-10E-L1-L= (L band) |

**Table B-5 10 Gigabit Ethernet Wide Area Network ATM Physical Layer (10GE WAN PHY) (9.953 Gbps) (continued)**

|             |                        |                       |                                                      |
|-------------|------------------------|-----------------------|------------------------------------------------------|
| Transponder | TXP_MR_10E with FEC    | Client 1+1<br>Y-Cable | 15454-10E-L1-C= (C band)<br>15454-10E-L1-L= (L band) |
| Transponder | TXP_MR_10E without FEC | Client 1+1<br>Y-Cable | 15454-10E-L1-C= (C band)<br>15454-10E-L1-L= (L band) |
| Transponder | TXP_MR_10G with FEC    | Client 1+1<br>Y-Cable | 15454-10T-L1-xx.y=                                   |
| Transponder | TXP_MR_10G without FEC | Client 1+1<br>Y-Cable | 15454-10T-L1-xx.y=                                   |

**Table B-6 10 Gigabit Ethernet Local Area Network ATM Physical Layer (10GE LAN PHY)(10.3 Gbps)**

| Interface Type | Card Type                                                                                      | Protection Type       | Product ID                                           |
|----------------|------------------------------------------------------------------------------------------------|-----------------------|------------------------------------------------------|
| Transponder    | TXP_MR_10E_C and TXP_MR_10E_L with EFEC                                                        | Client 1+1<br>Y-Cable | 15454-10E-L1-C= (C band)<br>15454-10E-L1-L= (L band) |
| Transponder    | TXP_MR_10E_C and TXP_MR_10E_L with FEC                                                         | Client 1+1<br>Y-Cable | 15454-10E-L1-C= (C band)<br>15454-10E-L1-L= (L band) |
| Transponder    | TXP_MR_10E_C and TXP_MR_10E_L without FEC                                                      | Client 1+1<br>Y-Cable | 15454-10E-L1-C= (C band)<br>15454-10E-L1-L= (L band) |
| Transponder    | TXP_MR_10E with EFEC                                                                           | Client 1+1<br>Y-Cable | 15454-10E-L1-C= (C band)<br>15454-10E-L1-L= (L band) |
| Transponder    | TXP_MR_10E with FEC                                                                            | Client 1+1<br>Y-Cable | 15454-10E-L1-C= (C band)<br>15454-10E-L1-L= (L band) |
| Transponder    | TXP_MR_10E without FEC                                                                         | Client 1+1<br>Y-Cable | 15454-10E-L1-C= (C band)<br>15454-10E-L1-L= (L band) |
| Transponder    | TXP_MR_10G with FEC                                                                            | Client 1+1<br>Y-Cable | 15454-10T-L1-xx.y=                                   |
| Transponder    | TXP_MR_10G without FEC                                                                         | Client 1+1<br>Y-Cable | 15454-10T-L1-xx.y=                                   |
| Transponder    | 10GE_XP with point-to-point traffic demand<br><br>XFPs with Ethernet aggregated traffic demand | Client 1+1<br>Y-Cable | 15454-10GE-XP = (Unprot)<br>15454-10GE-XP = (Prot)   |

**Table B-7 Gigabit Ethernet (1.25Gbps)**

| Interface Type | Card Type                                                                                                                                                                                                                                      | Protection Type | Product ID                 |
|----------------|------------------------------------------------------------------------------------------------------------------------------------------------------------------------------------------------------------------------------------------------|-----------------|----------------------------|
| Transponder    | MXP_MR_2.5G                                                                                                                                                                                                                                    | Client 1+1      | 15454-DM-L1-xx.y= (Unprot) |
|                | MXPP_MR_2.5G                                                                                                                                                                                                                                   | Y-Cable         | 15454-DMP-L1-xx.y= (Prot)  |
|                |                                                                                                                                                                                                                                                | Fiber-Switched  |                            |
| Transponder    | MXP_MR_10DME with EFEC                                                                                                                                                                                                                         | Client 1+1      | 15454-10DME-C= (C band)    |
|                |                                                                                                                                                                                                                                                | Y-Cable         | 15454-10DME-L= (L band)    |
| Transponder    | MXP_MR_10DME with FEC                                                                                                                                                                                                                          | Client 1+1      | 15454-10DME-C= (C band)    |
|                |                                                                                                                                                                                                                                                | Y-Cable         | 15454-10DME-L= (L band)    |
| Transponder    | MXP_MR_10DME without FEC                                                                                                                                                                                                                       | Client 1+1      | 15454-10DME-C= (C band)    |
|                |                                                                                                                                                                                                                                                | Y-Cable         | 15454-10DME-L= (L band)    |
| Transponder    | TXP_MR_2.5G                                                                                                                                                                                                                                    | Client 1+1      | 15454-MR-L1-xx.y= (Unprot) |
|                | TXPP_MR_2.5G with FEC                                                                                                                                                                                                                          | Y-Cable         | 15454-MRP-L1-xx.y= (Prot)  |
|                |                                                                                                                                                                                                                                                | Fiber-Switched  |                            |
| Transponder    | TXP_MR_2.5G                                                                                                                                                                                                                                    | Client 1+1      | 15454-MR-L1-xx.y= (Unprot) |
|                | TXPP_MR_2.5G without FEC                                                                                                                                                                                                                       | Y-Cable         | 15454-MRP-L1-xx.y= (Prot)  |
|                |                                                                                                                                                                                                                                                | Fiber-Switched  |                            |
| Pluggable      | GE DWDM GBIC                                                                                                                                                                                                                                   | Client 1+1      | 15454-GBIC-xx.y=           |
| Transponder    | GE_XP with point-to-point traffic demand configured on CTC as 10GE MXP<br><br>GE XP-O with point to point traffic demand and if configured on Cisco Transport Controller (CTC) as 20GE MXP<br><br>XFPs with Ethernet aggregated traffic demand | Client 1+1      | 15454-GE-XP = (Unprot)     |
|                |                                                                                                                                                                                                                                                | Y-Cable         | 15454-GE-XP = (Prot)       |
|                |                                                                                                                                                                                                                                                | Fiber-Switched  |                            |
| Transponder    | ADM-10G                                                                                                                                                                                                                                        | Client 1+1      | 15454-ADM-10G = (Unprot)   |
|                |                                                                                                                                                                                                                                                | Y-Cable         | 15454-ADM-10G = (Prot)     |
|                |                                                                                                                                                                                                                                                | Fiber-Switched  |                            |

**Table B-8 Fast Ethernet (100 Mbps)**

| Interface Type | Card Type                      | Protection Type | Product ID                 |
|----------------|--------------------------------|-----------------|----------------------------|
| Transponder    | TXP_MR_2.5G<br>TXPP_MR_2.5G 2R | Client 1+1      | 15454-MR-L1-xx.y= (Unprot) |
|                |                                | Y-Cable         | 15454-MRP-L1-xx.y= (Prot)  |
|                |                                | Fiber-Switched  |                            |

**Table B-9** *Fiber Channel 10G (10.5 Gbps)*

| Interface Type | Card Type                                       | Protection Type | Product ID               |
|----------------|-------------------------------------------------|-----------------|--------------------------|
| Transponder    | TXP_MR_10E_C and<br>TXP_MR_10E_L with<br>EFEC   | Client 1+1      | 15454-10E-L1-C= (C band) |
|                |                                                 | Y-Cable         | 15454-10E-L1-L= (L band) |
| Transponder    | TXP_MR_10E_C and<br>TXP_MR_10E_L with FEC       | Client 1+1      | 15454-10E-L1-C= (C band) |
|                |                                                 | Y-Cable         | 15454-10E-L1-L= (L band) |
| Transponder    | TXP_MR_10E_C and<br>TXP_MR_10E_L without<br>FEC | Client 1+1      | 15454-10E-L1-C= (C band) |
|                |                                                 | Y-Cable         | 15454-10E-L1-L= (L band) |
| Transponder    | TXP_MR_10E with EFEC                            | Client 1+1      | 15454-10E-L1-C= (C band) |
|                |                                                 | Y-Cable         | 15454-10E-L1-L= (L band) |
| Transponder    | TXP_MR_10E with FEC                             | Client 1+1      | 15454-10E-L1-C= (C band) |
|                |                                                 | Y-Cable         | 15454-10E-L1-L= (L band) |
| Transponder    | TXP_MR_10E without FEC                          | Client 1+1      | 15454-10E-L1-C= (C band) |
|                |                                                 | Y-Cable         | 15454-10E-L1-L= (L band) |
| Transponder    | TXP_MR_10E<br>TXP_MR_10E_y                      | Client 1+1      | 15454-10E-L1-C= (C band) |
|                |                                                 | Y-Cable         | 15454-10E-L1-L= (L band) |

**Table B-10** *Fiber Channel 4G (4.25 Gbps)*

| Interface Type | Card Type                   | Protection Type | Product ID              |
|----------------|-----------------------------|-----------------|-------------------------|
| Transponder    | MXP_MR_10DME with<br>EFEC   | Client 1+1      | 15454-10DME-C= (C band) |
|                |                             | Y-Cable         | 15454-10DME-L= (L band) |
| Transponder    | MXP_MR_10DME with FEC       | Client 1+1      | 15454-10DME-C= (C band) |
|                |                             | Y-Cable         | 15454-10DME-L= (L band) |
| Transponder    | MXP_MR_10DME without<br>FEC | Client 1+1      | 15454-10DME-C= (C band) |
|                |                             | Y-Cable         | 15454-10DME-L= (L band) |

**Table B-11** *Fiber Channel 2G (2.125 Gbps)*

| Interface Type | Card Type                   | Protection Type | Product ID                 |
|----------------|-----------------------------|-----------------|----------------------------|
| Transponder    | MXP_MR_2.5G<br>MXPP_MR_2.5G | Client 1+1      | 15454-DM-L1-xx.y= (Unprot) |
|                |                             | Y-Cable         | 15454-DMP-L1-xx.y= (Prot)  |
|                |                             | Fiber-Switched  |                            |
| Transponder    | MXP_MR_10DME with<br>EFEC   | Client 1+1      | 15454-10DME-C= (C band)    |
|                |                             | Y-Cable         | 15454-10DME-L= (L band)    |
| Transponder    | MXP_MR_10DME with FEC       | Client 1+1      | 15454-10DME-C= (C band)    |
|                |                             | Y-Cable         | 15454-10DME-L= (L band)    |

**Table B-11 Fiber Channel 2G (2.125 Gbps) (continued)**

|             |                                         |                                         |                                                         |
|-------------|-----------------------------------------|-----------------------------------------|---------------------------------------------------------|
| Transponder | MXP_MR_10DME without FEC                | Client 1+1<br>Y-Cable                   | 15454-10DME-C= (C band)<br>15454-10DME-L= (L band)      |
| Transponder | TXP_MR_2.5G<br>TXPP_MR_2.5G with FEC    | Client 1+1<br>Y-Cable<br>Fiber-Switched | 15454-MR-L1-xx.y= (Unprot)<br>15454-MRP-L1-xx.y= (Prot) |
| Transponder | TXP_MR_2.5G<br>TXPP_MR_2.5G without FEC | Client 1+1<br>Y-Cable<br>Fiber-Switched | 15454-MR-L1-xx.y= (Unprot)<br>15454-MRP-L1-xx.y= (Prot) |

**Table B-12 Fiber Channel 1G (1.062 Gbps)**

| Interface Type | Card Type                               | Protection Type                         | Product ID                                              |
|----------------|-----------------------------------------|-----------------------------------------|---------------------------------------------------------|
| Transponder    | MXP_MR_2.5G<br>MXPP_MR_2.5G             | Client 1+1<br>Y-Cable<br>Fiber-Switched | 15454-DM-L1-xx.y= (Unprot)<br>15454-DMP-L1-xx.y= (Prot) |
| Transponder    | MXP_MR_10DME with EFEC                  | Client 1+1<br>Y-Cable                   | 15454-10DME-C= (C band)<br>15454-10DME-L= (L band)      |
| Transponder    | MXP_MR_10DME with FEC                   | Client 1+1<br>Y-Cable                   | 15454-10DME-C= (C band)<br>15454-10DME-L= (L band)      |
| Transponder    | MXP_MR_10DME without FEC                | Client 1+1<br>Y-Cable                   | 15454-10DME-C= (C band)<br>15454-10DME-L= (L band)      |
| Transponder    | TXP_MR_2.5G<br>TXPP_MR_2.5G with FEC    | Client 1+1<br>Y-Cable<br>Fiber-Switched | 15454-MR-L1-xx.y= (Unprot)<br>15454-MRP-L1-xx.y= (Prot) |
| Transponder    | TXP_MR_2.5G<br>TXPP_MR_2.5G without FEC | Client 1+1<br>Y-Cable<br>Fiber-Switched | 15454-MR-L1-xx.y= (Unprot)<br>15454-MRP-L1-xx.y= (Prot) |

**Table B-13 2 Gbps Fiber Connectivity (2.125 Gbps)**

| Interface Type | Card Type                   | Protection Type                         | Product ID                                              |
|----------------|-----------------------------|-----------------------------------------|---------------------------------------------------------|
| Transponder    | MXP_MR_2.5G<br>MXPP_MR_2.5G | Client 1+1<br>Y-Cable<br>Fiber-Switched | 15454-DM-L1-xx.y= (Unprot)<br>15454-DMP-L1-xx.y= (Prot) |
| Transponder    | MXP_MR_10DME with EFEC      | Client 1+1<br>Y-Cable                   | 15454-10DME-C= (C band)<br>15454-10DME-L= (L band)      |

**Table B-13 2 Gbps Fiber Connectivity (2.125 Gbps) (continued)**

|             |                                         |                                         |                                                         |
|-------------|-----------------------------------------|-----------------------------------------|---------------------------------------------------------|
| Transponder | MXP_MR_10DME with FEC                   | Client 1+1<br>Y-Cable                   | 15454-10DME-C= (C band)<br>15454-10DME-L= (L band)      |
| Transponder | MXP_MR_10DME without FEC                | Client 1+1<br>Y-Cable                   | 15454-10DME-C= (C band)<br>15454-10DME-L= (L band)      |
| Transponder | TXP_MR_2.5G<br>TXPP_MR_2.5G with FEC    | Client 1+1<br>Y-Cable<br>Fiber-Switched | 15454-MR-L1-xx.y= (Unprot)<br>15454-MRP-L1-xx.y= (Prot) |
| Transponder | TXP_MR_2.5G<br>TXPP_MR_2.5G without FEC | Client 1+1<br>Y-Cable<br>Fiber-Switched | 15454-MR-L1-xx.y= (Unprot)<br>15454-MRP-L1-xx.y= (Prot) |

**Table B-14 FICON-1G (1.062 Gbps)**

| Interface Type | Card Type                               | Protection Type                         | Product ID                                              |
|----------------|-----------------------------------------|-----------------------------------------|---------------------------------------------------------|
| Transponder    | MXP_MR_2.5G<br>MXPP_MR_2.5G             | Client 1+1<br>Y-Cable<br>Fiber-Switched | 15454-DM-L1-xx.y= (Unprot)<br>15454-DMP-L1-xx.y= (Prot) |
| Transponder    | MXP_MR_10DME with EFEC                  | Client 1+1<br>Y-Cable                   | 15454-10DME-C= (C band)<br>15454-10DME-L= (L band)      |
| Transponder    | MXP_MR_10DME with FEC                   | Client 1+1<br>Y-Cable                   | 15454-10DME-C= (C band)<br>15454-10DME-L= (L band)      |
| Transponder    | MXP_MR_10DME without FEC                | Client 1+1<br>Y-Cable                   | 15454-10DME-C= (C band)<br>15454-10DME-L= (L band)      |
| Transponder    | TXP_MR_2.5G<br>TXPP_MR_2.5G with FEC    | Client 1+1<br>Y-Cable<br>Fiber-Switched | 15454-MR-L1-xx.y= (Unprot)<br>15454-MRP-L1-xx.y= (Prot) |
| Transponder    | TXP_MR_2.5G<br>TXPP_MR_2.5G without FEC | Client 1+1<br>Y-Cable<br>Fiber-Switched | 15454-MR-L1-xx.y= (Unprot)<br>15454-MRP-L1-xx.y= (Prot) |

**Table B-15 Enterprise System Connection (ESCON) (200 Mbps)**

| Interface Type | Card Type | Protection Type | Product ID |
|----------------|-----------|-----------------|------------|
|----------------|-----------|-----------------|------------|

**Table B-15 Enterprise System Connection (ESCON) (200 Mbps) (continued)**

|             |                 |                           |                            |
|-------------|-----------------|---------------------------|----------------------------|
| Transponder | MXP_MR_2.5G     | Client 1+1                | 15454-DM-L1-xx.y= (Unprot) |
|             | MXPP_MR_2.5G    | Y-Cable<br>Fiber-Switched | 15454-DMP-L1-xx.y= (Prot)  |
| Transponder | TXP_MR_2.5G     | Client 1+1                | 15454-MR-L1-xx.y= (Unprot) |
|             | TXPP_MR_2.5G 2R | Y-Cable<br>Fiber-Switched | 15454-MRP-L1-xx.y= (Prot)  |

**Table B-16 ISC-3 Compatibility Mode (1.062 Gbps)**

| Interface Type | Card Type                | Protection Type | Product ID                 |
|----------------|--------------------------|-----------------|----------------------------|
| Transponder    | TXP_MR_2.5G without FEC  | Client 1+1      | 15454-MR-L1-xx.y= (Unprot) |
|                |                          |                 | 15454-MRP-L1-xx.y= (Prot)  |
| Transponder    | MXP_MR_10DME with EFEC   | Client 1+1      | 15454-10DME-C= (C band)    |
|                |                          |                 | 15454-10DME-L= (L band)    |
| Transponder    | MXP_MR_10DME with FEC    | Client 1+1      | 15454-10DME-C= (C band)    |
|                |                          |                 | 15454-10DME-L= (L band)    |
| Transponder    | MXP_MR_10DME without FEC | Client 1+1      | 15454-10DME-C= (C band)    |
|                |                          |                 | 15454-10DME-L= (L band)    |

**Table B-17 ISC-Peer 2R**

| Interface Type | Card Type      | Protection Type | Product ID                 |
|----------------|----------------|-----------------|----------------------------|
| Transponder    | TXP_MR_2.5G 2R | Client 1+1      | 15454-MR-L1-xx.y= (Unprot) |
|                |                |                 | 15454-MRP-L1-xx.y= (Prot)  |

**Table B-18 ISC-3 Peer-1G (1.062 Gbps)**

| Interface Type | Card Type                | Protection Type | Product ID              |
|----------------|--------------------------|-----------------|-------------------------|
| Transponder    | MXP_MR_10DME with EFEC   | Client 1+1      | 15454-10DME-C= (C band) |
|                |                          | Y-Cable         | 15454-10DME-L= (L band) |
| Transponder    | MXP_MR_10DME with FEC    | Client 1+1      | 15454-10DME-C= (C band) |
|                |                          | Y-Cable         | 15454-10DME-L= (L band) |
| Transponder    | MXP_MR_10DME without FEC | Client 1+1      | 15454-10DME-C= (C band) |
|                |                          | Y-Cable         | 15454-10DME-L= (L band) |

**Table B-19** *ISC-3 Peer-2G (2.125 Gbps)*

| Interface Type | Card Type                | Protection Type | Product ID              |
|----------------|--------------------------|-----------------|-------------------------|
| Transponder    | MXP_MR_10DME with EFEC   | Client 1+1      | 15454-10DME-C= (C band) |
|                |                          | Y-Cable         | 15454-10DME-L= (L band) |
| Transponder    | MXP_MR_10DME with FEC    | Client 1+1      | 15454-10DME-C= (C band) |
|                |                          | Y-Cable         | 15454-10DME-L= (L band) |
| Transponder    | MXP_MR_10DME without FEC | Client 1+1      | 15454-10DME-C= (C band) |
|                |                          | Y-Cable         | 15454-10DME-L= (L band) |

**Table B-20** *Sysplex External Throughput Rate (8 Mbps)*

| Interface Type | Card Type      | Protection Type | Product ID                 |
|----------------|----------------|-----------------|----------------------------|
| Transponder    | TXP_MR_2.5G 2R | Client 1+1      | 15454-MR-L1-xx.y= (Unprot) |
|                |                |                 | 15454-MRP-L1-xx.y= (Prot)  |

**Table B-21** *Sysplex Control Link Oscillator (8 Mbps)*

| Interface Type | Card Type      | Protection Type | Product ID                 |
|----------------|----------------|-----------------|----------------------------|
| Transponder    | TXP_MR_2.5G 2R | Client 1+1      | 15454-MR-L1-xx.y= (Unprot) |
|                |                |                 | 15454-MRP-L1-xx.y= (Prot)  |

**Table B-22** *Serial Data Input*

| Interface Type | Card Type                      | Protection Type | Product ID                 |
|----------------|--------------------------------|-----------------|----------------------------|
| Transponder    | TXP_MR_2.5G<br>TXPP_MR_2.5G 2R | Client 1+1      | 15454-MR-L1-xx.y= (Unprot) |
|                |                                | Y-Cable         | 15454-MRP-L1-xx.y= (Prot)  |
|                |                                | Fiber-Switched  |                            |

**Table B-23** *Digital Video Broadcast-Asynchronous Serial Interface*

| Interface Type | Card Type                      | Protection Type | Product ID                 |
|----------------|--------------------------------|-----------------|----------------------------|
| Transponder    | TXP_MR_2.5G<br>TXPP_MR_2.5G 2R | Client 1+1      | 15454-MR-L1-xx.y= (Unprot) |
|                |                                | Y-Cable         | 15454-MRP-L1-xx.y= (Prot)  |
|                |                                | Fiber-Switched  |                            |



**Table B-24 D1-Video (270 Mbps)**

| Interface Type | Card Type                      | Protection Type | Product ID                 |
|----------------|--------------------------------|-----------------|----------------------------|
| Transponder    | TXP_MR_2.5G<br>TXPP_MR_2.5G 2R | Client 1+1      | 15454-MR-L1-xx.y= (Unprot) |
|                |                                | Y-Cable         | 15454-MRP-L1-xx.y= (Prot)  |
|                |                                | Fiber-Switched  |                            |

**Table B-25 High Definition Television (HDTV) (1.48 Gbps)**

| Interface Type | Card Type                      | Protection Type | Product ID                 |
|----------------|--------------------------------|-----------------|----------------------------|
| Transponder    | TXP_MR_2.5G<br>TXPP_MR_2.5G 2R | Client 1+1      | 15454-MR-L1-xx.y= (Unprot) |
|                |                                | Y-Cable         | 15454-MRP-L1-xx.y= (Prot)  |
|                |                                | Fiber-Switched  |                            |

**Table B-26 DV-6000 (2.38 Gbps)**

| Interface Type | Card Type                      | Protection Type | Product ID                 |
|----------------|--------------------------------|-----------------|----------------------------|
| Transponder    | TXP_MR_2.5G<br>TXPP_MR_2.5G 2R | Client 1+1      | 15454-MR-L1-xx.y= (Unprot) |
|                |                                | Y-Cable         | 15454-MRP-L1-xx.y= (Prot)  |
|                |                                | Fiber-Switched  |                            |

**Table B-27 2R Any Rate**

| Interface Type | Card Type                      | Protection Type | Product ID                 |
|----------------|--------------------------------|-----------------|----------------------------|
| Transponder    | TXP_MR_2.5G<br>TXPP_MR_2.5G 2R | Client 1+1      | 15454-MR-L1-xx.y= (Unprot) |
|                |                                | Y-Cable         | 15454-MRP-L1-xx.y= (Prot)  |
|                |                                | Fiber-Switched  |                            |

**Table B-28 ONS 15530 2.5G ITU-T**

| Interface Type | Card Type                          | Protection Type | Product ID                  |
|----------------|------------------------------------|-----------------|-----------------------------|
| TXP            | MR MM TXP                          | Client 1+1      | 15530-TSP1-xx21 (MM Unprot) |
|                | MR SM TXP                          | Fiber-Switched  | 15530-TSP1-xx22 (SM Unprot) |
|                | MR MM TXP with splitter            |                 | 15530-TSP1-xx11 (MM Prot)   |
|                | MR SM TXP with splitter            |                 | 15530-TSP1-xx12 (SM Prot)   |
| LC             | 2.5-Gbps Aggregation               | Client 1+1      | 15530-ITU3-xx20 (Unprot)    |
|                | 2.5-Gbps Aggregation with splitter | Fiber-Switched  | 15530-ITU3-xx10 (Prot)      |

**Table B-29 ONS 15530 10G ITU-T**

| <b>Interface Type</b> | <b>Card Type</b>                  | <b>Protection Type</b> | <b>Product ID</b>        |
|-----------------------|-----------------------------------|------------------------|--------------------------|
| LC                    | 10-Gbps Aggregation               | Client 1+1             | 15530-ITU2-xx20 (Unprot) |
|                       | 10-Gbps Aggregation with splitter | Fiber-Switched         | 15530-ITU2-xx10 (Prot)   |
| MXP                   | Data Muxponder                    | Client 1+1             | 15530-MSMP-xx22 (Unprot) |
|                       | Data Muxponder with splitter      | Fiber-Switched         | 15530-MSMP-xx12 (Prot)   |



# APPENDIX C

## System Messages

This appendix lists Cisco TransportPlanner system messages ([Table C-1](#)).

**Table C-1**      **Error Messages**

| Message Type    | Error Message                                                                                                 |
|-----------------|---------------------------------------------------------------------------------------------------------------|
| Traffic mapping | Wavelength {0} <sup>1</sup> may require additional ASE filtering.                                             |
| Traffic mapping | 50GHz scalability is supported only with {0} design rules.                                                    |
| Traffic mapping | The network is broken: please connect all the sites together.                                                 |
| Traffic mapping | The traffic model is empty: please add at least one service request.                                          |
| Traffic mapping | Number of Add/Drop nodes exceeded the maximum ({0}) allowed in the network.                                   |
| Traffic mapping | ONS15454 DWDM platform supports up to {0} non-pass-through sites.                                             |
| Traffic mapping | Line+ sites can't support DMX-O units due to layout constraints.                                              |
| Traffic mapping | Line+ sites can't support Individual Shelf with DCC chain option due to layout constraints.                   |
| Traffic mapping | Client {0} is not available in the equipment list.                                                            |
| Traffic mapping | Any to Any traffic is not supported by {0} rules.                                                             |
| Traffic mapping | Any to Any traffic requires ROADM units but ROADM is not allowed by restricted equipment list.                |
| Traffic mapping | Can't place ROADM units in site {0} to support Any to Any traffic.                                            |
| Traffic mapping | ROADM configuration is not allowed by restricted equipment list.                                              |
| Traffic mapping | Mux Demux configuration is not allowed by restricted equipment list.                                          |
| Traffic mapping | Only ROADM configuration is allowed with selected design rules.                                               |
| Traffic mapping | ROADM is not allowed by the selected design rules.                                                            |
| Traffic mapping | ROADM-O is not allowed with L band.                                                                           |
| Traffic mapping | Line+ or Terminal+ site topologies are not allowed by selected design rules.                                  |
| Traffic mapping | Line+ or Terminal+ site topologies require ROADM units but ROADM is not allowed by restricted equipment list. |

**Table C-1 Error Messages (continued)**

| Message Type    | Error Message                                                                                                                                                         |
|-----------------|-----------------------------------------------------------------------------------------------------------------------------------------------------------------------|
| Traffic mapping | OADM unit {0} defined in {1} is not allowed by restricted equipment list.                                                                                             |
| Traffic mapping | Can't find a valid aggregating client.                                                                                                                                |
| Traffic mapping | Can't find a valid client.                                                                                                                                            |
| Traffic mapping | Client {0} can't be tuned on wavelength {1}.                                                                                                                          |
| Traffic mapping | Forced wavelength {0} is outside selected band.                                                                                                                       |
| Traffic mapping | Forced client {0} can't be tuned on selected band.                                                                                                                    |
| Traffic mapping | Interface Type {0} is not supported by the selected Design Rules.                                                                                                     |
| Traffic mapping | Add/Drop not available in site {0}.                                                                                                                                   |
| Traffic mapping | Maximum wavelength re-usage reached for ITU channel {0}.                                                                                                              |
| Traffic mapping | All solutions exceed {0} wavelengths. See the <a href="#">“C.1.1 Wavelength Exceeded”</a> section on page C-12.                                                       |
| Traffic mapping | The anti ASE option is available only in sites with add/drop capability.                                                                                              |
| Traffic mapping | More than one anti ASE site was selected.                                                                                                                             |
| Traffic mapping | No specific anti-ASE node is required for this traffic matrix requirement.                                                                                            |
| Traffic mapping | Protected services are not allowed with linear networks.                                                                                                              |
| Traffic mapping | In a network with hub nodes protected services are allowed only between hub sites.                                                                                    |
| Traffic mapping | Invalid routing (out of network boundary). See the <a href="#">“C.1.2 Invalid Routing”</a> section on page C-13.                                                      |
| Traffic mapping | Can't route service with optical bypass in {0}.                                                                                                                       |
| Traffic mapping | Can't find alternate route due to multiple HUB nodes along the path. See the <a href="#">“C.1.3 Cannot Find Alternate Route”</a> section on page C-13.                |
| Traffic mapping | Can't route service through HUB node {0}. See the <a href="#">“C.1.4 Cannot Route Service”</a> section on page C-14.                                                  |
| Traffic mapping | Overlapped services assigned to the same wavelength. See the <a href="#">“C.1.5 Overlapped Services Assigned to the Same Wavelength”</a> section on page C-14.        |
| Traffic mapping | Protected services assigned to the same wavelength. See the <a href="#">“C.1.6 Protected Services Assigned to the Same Wavelength”</a> section on page C-15.          |
| Traffic mapping | Can't route service due to add drop equipment constraints. See the <a href="#">“C.1.7 Cannot Route Service Because of Add/Drop Constraints”</a> section on page C-15. |
| Traffic mapping | Design requires forcing a site as ROADM or Full Mux/Demux but no valid site was found.                                                                                |
| Traffic mapping | Design requires forcing site as ROADM or Full Mux/Demux: remove equipment constraints.                                                                                |

**Table C-1 Error Messages (continued)**

| Message Type    | Error Message                                                                                                |
|-----------------|--------------------------------------------------------------------------------------------------------------|
| Traffic mapping | Path constraints prevent routing of {0}                                                                      |
| Traffic mapping | Traffic subnet constraints prevent routing of {0}                                                            |
| Traffic mapping | In a linear network, terminal sites must have structure Terminal                                             |
| Traffic mapping | Wavelength {0} may require additional ASE filtering                                                          |
| Traffic mapping | 50GHz scalability is supported only with {0} design rules                                                    |
| Traffic mapping | The Network is broken: please connect all the sites together                                                 |
| Traffic mapping | The traffic model is empty: please add at least one service request                                          |
| Traffic mapping | Number of Add/Drop nodes exceeded the maximum ( {0} ) allowed in the network                                 |
| Traffic mapping | ONS15454 DWDM platform supports up to {0} non-pass-through sites                                             |
| Traffic mapping | Line+ sites can't support DMX-O units due to layout constraints                                              |
| Traffic mapping | Line+ sites can't support Individual Shelf with DCC chain option due to layout constraints                   |
| Traffic mapping | Client {0} is not available in the equipment list                                                            |
| Traffic mapping | Any to Any traffic is not supported by {0} rules                                                             |
| Traffic mapping | Any to Any traffic requires ROADM units but ROADM is not allowed by restricted equipment list                |
| Traffic mapping | Can't place ROADM units in site {0} to support Any to Any traffic                                            |
| Traffic mapping | ROADM configuration is not allowed by restricted equipment list                                              |
| Traffic mapping | WXC configuration is not allowed by restricted equipment list                                                |
| Traffic mapping | Mux Demux configuration is not allowed by restricted equipment list                                          |
| Traffic mapping | Only ROADM configuration is allowed with selected design rules                                               |
| Traffic mapping | Multi-degree structure in site {0} is not allowed with selected design rules                                 |
| Traffic mapping | ROADM is not allowed by the selected design rules                                                            |
| Traffic mapping | ROADM-O is not allowed with L band                                                                           |
| Traffic mapping | Line+ or Terminal+ site topologies are not allowed by selected design rules                                  |
| Traffic mapping | Line+ or Terminal+ site topologies require ROADM units but ROADM is not allowed by restricted equipment list |
| Traffic mapping | OADM unit {0} defined in {1} is not allowed by restricted equipment list                                     |
| Traffic mapping | Can't find a valid aggregating client                                                                        |
| Traffic mapping | Can't find a valid client                                                                                    |
| Traffic mapping | Can't find a valid XFP                                                                                       |
| Traffic mapping | Client {0} can't be tuned on wavelength {1}                                                                  |
| Traffic mapping | Forced wavelength {0} is outside selected band                                                               |

**Table C-1 Error Messages (continued)**

| Message Type    | Error Message                                                                         |
|-----------------|---------------------------------------------------------------------------------------|
| Traffic mapping | Forced client {0} can't be tuned on selected band                                     |
| Traffic mapping | Interface Type {0} is not supported by the selected Design Rules                      |
| Traffic mapping | Add/Drop not available in site {0}                                                    |
| Traffic mapping | Maximum wavelength re-usage reached for ITU channel {0}                               |
| Traffic mapping | All solutions exceed {0} wavelengths                                                  |
| Traffic mapping | The anti ASE option is available only in sites with add/drop capability               |
| Traffic mapping | More than one anti ASE site was selected                                              |
| Traffic mapping | No specific anti-ASE node is required for this traffic matrix requirement             |
| Traffic mapping | Protected services are not allowed with linear networks                               |
| Traffic mapping | In a network with hub nodes protected services are allowed only between hub sites     |
| Traffic mapping | Invalid routing (out of network boundary)                                             |
| Traffic mapping | Can't route service with optical bypass in {0}                                        |
| Traffic mapping | Can't find alternate route due to HUB nodes along the path                            |
| Traffic mapping | Can't route service through HUB node {0}                                              |
| Traffic mapping | Overlapped services assigned to the same wavelength                                   |
| Traffic mapping | Protected services assigned to the same wavelength                                    |
| Traffic mapping | Can't route service due to add drop equipment constraints                             |
| Traffic mapping | Design requires forcing a site as ROADM or Full Mux/Demux but no valid site was found |
| Traffic mapping | Design requires forcing site as ROADM or Full Mux/Demux: remove equipment constraints |
| Traffic mapping | PP4 is not allowed in site {0} (fiber interfaces are limited to A,B,C and D)          |
| Traffic mapping | No valid path from {0} to {1}                                                         |
| Traffic mapping | No valid path from {0} to {1}, bypass in {2}                                          |
| Traffic mapping | Wavelength forced outside of selected band for {0}                                    |
| Traffic mapping | Client {0} can't be tuned at {1}                                                      |
| Traffic mapping | Invalid functionality option for structure {0} in site {1}                            |
| Traffic mapping | Invalid mux - demux configuration in site {0}                                         |
| Traffic mapping | Invalid mux - demux combination on two sides of site {0}                              |
| Traffic mapping | Unit options are not compatible with design rule {0} in site {1}                      |
| Traffic mapping | Unit {0} is not available in Restricted Equipment List                                |
| Traffic mapping | Mesh topology not supported yet                                                       |
| Traffic mapping | Network Cluster {0} requires mesh algorithm                                           |
| Traffic mapping | Unconnected site {0}                                                                  |

**Table C-1 Error Messages (continued)**

| Message Type        | Error Message                                                                                                         |
|---------------------|-----------------------------------------------------------------------------------------------------------------------|
| Traffic mapping     | Incompatible port {0} assignment in site {1}                                                                          |
| Traffic mapping     | Only one GE-STS24 can be assigned to port {0} in site {1}                                                             |
| Traffic mapping     | Incompatible rate/reach options circuit {0}                                                                           |
| Traffic mapping     | Incompatible rate/reach options for port {0} in site {1}                                                              |
| Traffic mapping     | Incompatible CIR settings for port {0} in site {1}                                                                    |
| Traffic mapping     | Can't find a valid SFP for port {0} in site {1}                                                                       |
| Traffic mapping     | Port {0} in site {1} is not available                                                                                 |
| Traffic mapping     | Exceeded rate for port {0} in site {1}                                                                                |
| Traffic mapping     | Can't provision circuit {0}                                                                                           |
| Traffic mapping     | Maximum frame rate exceeded in section {0} - {1}                                                                      |
| Traffic mapping     | Maximum frame rate exceeded in node {0}                                                                               |
| Traffic mapping     | Protected circuits are not allowed in a linear traffic subnet                                                         |
| Traffic mapping     | Invalid routing {0}                                                                                                   |
| Traffic mapping     | Client protection is not allowed if all nodes are single card configuration                                           |
| Traffic mapping     | Trunk protection with no client protection is not allowed if at least one node is double card configuration           |
| Traffic mapping     | Client protection with no trunk protection is not allowed if at least one node is double card configuration           |
| Traffic mapping     | Errors were found on {0}: please run the checker and fix all problems                                                 |
| Traffic mapping     | Client and trunk protections are not allowed at the same time on port {0} in site {1}                                 |
| Traffic mapping     | 50GHz scalability is not supported with Ethernet or TDM aggregated demands                                            |
| Traffic mapping     | Cards required for {0} demand are not available in the equipment list                                                 |
| Traffic mapping     | Impossible to find two independent paths for protected service                                                        |
| Traffic mapping     | Structure {0} is not supported for design rule {1}                                                                    |
| Traffic mapping     | No available wavelegth found due to traffic constraints                                                               |
| Traffic mapping     | Too many Add/Drop nodes ({0} > {1}) in cluster {2}                                                                    |
| Traffic mapping     | Too many nodes ({0} > {1}) in cluster {2}                                                                             |
| Traffic mapping     | Too many ROADM nodes ({0} > {1}) in group {2}                                                                         |
| Traffic mapping     | Demand {0} defined om traffic subnet {1} is in an invalid status                                                      |
| Traffic mapping     | Demand {0} is crossing different sites clusters                                                                       |
| Traffic mapping     | PP4 forced on site {0} can handle at most 4 sides                                                                     |
| Amplifier Placement | In {0}, MMU mandatory requires OPT-AMP-L in booster and pre position. Please remove any other amplifier type forcing. |

**Table C-1 Error Messages (continued)**

| <b>Message Type</b> | <b>Error Message</b>                                                                                             |
|---------------------|------------------------------------------------------------------------------------------------------------------|
| Amplifier Placement | In {0}, MMU mandatory requires OPT-PRE and OPT-BST-E. Please remove any other amplifier type forcing.            |
| Amplifier Placement | In {0}, cannot force a demux if it is not supported by site type.                                                |
| Amplifier Placement | In {0}, cannot force a mux if it is not supported by site type.                                                  |
| Amplifier Placement | In {0}, cannot force an in-line attenuator if it is not supported by site type.                                  |
| Amplifier Placement | In {0}, cannot force an in-line attenuator because of presence of OADMs in the other side.                       |
| Amplifier Placement | Invalid forcing in amplifier node of {0} because of Pass-through site forcing.                                   |
| Amplifier Placement | In {0}, cannot force unplaced OSC card in a non Pass-through site.                                               |
| Amplifier Placement | In {0}, cannot force OSCM without an amplifier forced.                                                           |
| Amplifier Placement | Cannot force output power or tilt in {0} without the related amplifier forced.                                   |
| Amplifier Placement | Cannot force input attenuator in {0} without the related amplifier forced.                                       |
| Amplifier Placement | Cannot force DCUs in {0} without forcing an amplifier that supports them.                                        |
| Amplifier Placement | Incompatible types for DCU couple in {0}.                                                                        |
| Amplifier Placement | Incompatible dispersion modules in {0}                                                                           |
| Amplifier Placement | In {0}, output power is out of limits of amplifier selected.                                                     |
| Amplifier Placement | In {0}, amplifier tilt is out of allowed range.                                                                  |
| Amplifier Placement | Couple between {1} and {2} has an invalid value in {0}                                                           |
| Amplifier Placement | Couple between {0} and {1} is of invalid type                                                                    |
| Amplifier Placement | Fibre between {1} and {2} has an invalid value in {0}                                                            |
| Amplifier Placement | Fibre between {0} and {1} has SOL total loss greater than EOL total loss.                                        |
| Amplifier Placement | Can't respect forcing on {0} attenuator (on channel {1}) in {2} {3} {4}. No A/D ports are available              |
| Amplifier Placement | A {0} attenuator (on channel {1}) in {2} {3} {4} was present, but A/D ports on this channel are longer available |
| Amplifier Placement | Tilt forced on {0} in {1} {2} {3} when no-tilt design option is selected                                         |
| Amplifier Placement | DMX-O is suggested as drop unit in {0} instead of the forced DMX.                                                |
| Amplifier Placement | DMX might cause problems during channels provisioning and or in case of equipment failures.                      |
| Amplifier Placement | Fail low channel threshold cannot be set in {0} {1} {2}; please allow placement of booster amplifier.            |
| Amplifier Placement | In {0}, {1} is working in an invalid mode (power control mode).                                                  |



**Table C-1 Error Messages (continued)**

| <b>Message Type</b> | <b>Error Message</b>                                                                                                                                         |
|---------------------|--------------------------------------------------------------------------------------------------------------------------------------------------------------|
| Amplifier Placement | In case of fibre cut or equipment failure, channels survivability might not be guaranteed.                                                                   |
| Amplifier Placement | In {0}, {1} is working with a gain of {2} dB: this value is below its minimum allowed gain.                                                                  |
| Amplifier Placement | In {0}, {1} in EOL condition will be working with a gain of {2} dB: this value is below its minimum allowed gain.                                            |
| Amplifier Placement | In {0}, {1} is working with a gain of {2} dB: this value exceeds its maximum allowed gain.                                                                   |
| Amplifier Placement | In {0}, {1} in EOL condition will be working with a gain of {2} dB: this value exceeds its maximum allowed gain.                                             |
| Amplifier Placement | In {0}, {1} cannot respect user forcing.                                                                                                                     |
| Amplifier Placement | Site {0} cannot be installed without Cisco TransportPlanner configuration file.                                                                              |
| Amplifier Placement | In {0}, {1} cannot respect user forcing due to {2}.                                                                                                          |
| Amplifier Placement | Unsupported configuration due to excessive number of amplifiers (max {0} per directions).                                                                    |
| Amplifier Placement | Unsupported configuration due to excessive number of OSC regen sites (max {0}).                                                                              |
| Amplifier Placement | In {0}, channel power is near the fail low threshold.                                                                                                        |
| Amplifier Placement | In {0}, channel power is below the fail low threshold.                                                                                                       |
| Amplifier Placement | In {0}, OSC channel power is near the fail low threshold.                                                                                                    |
| Amplifier Placement | In {0}, OSC channel power is below the fail low threshold.                                                                                                   |
| Amplifier Placement | Network cannot be installed as one or more OSC links are unfeasible.                                                                                         |
| Amplifier Placement | If possible, try selecting DCN extension option on the longest spans.                                                                                        |
| Amplifier Placement | Try to unfreeze amplifier or DCUs in site {0}, interface {1}, {2} position                                                                                   |
| Amplifier Placement | Transmission error. Please contact custom design.                                                                                                            |
| Amplifier Placement | Transmission error on channel {0}. Please contact custom design.                                                                                             |
| Amplifier Placement | Excessive ROADM crossTalk penalty on channel {0}. Try to lower the output power of the preamplifier in the Roadm site in which the failed channels are added |
| Amplifier Placement | Excessive filtering penalty on channel {0}. Please contact custom design                                                                                     |
| Amplifier Placement | Filtering problem on channel {0}. Please contact custom design                                                                                               |
| Amplifier Placement | Excessive PMD on channel {0}. Please contact custom design.                                                                                                  |
| Amplifier Placement | Excessive SC on channel {0}. Please contact custom design.                                                                                                   |
| Amplifier Placement | In site {0} the Pass Through forcing and DCN Extension option are incompatible                                                                               |

**Table C-1 Error Messages (continued)**

| <b>Message Type</b>  | <b>Error Message</b>                                                                                                                 |
|----------------------|--------------------------------------------------------------------------------------------------------------------------------------|
| Amplifier Placement  | In site {0} an external DCN access must be provided for DCN functionality                                                            |
| Amplifier Placement  | If Installation W/O MP is selected, the node mandatory requires preamplifier (PRE or AMP-L) otherwise it must be set as Pass-Through |
| Amplifier Placement  | If Installation W/O MP is selected in the site, amplifiers output power cannot be forced.                                            |
| Amplifier Placement  | If Installation W/O MP is selected in the site, Fibre Switch protection scheme is not supported.                                     |
| Amplifier Placement  | If Installation W/O MP is selected in the site, only "32 Chs +5 dbm/Ch" and "40 Chs +4 dbm/Ch" power rules are supported.            |
| Amplifier Placement  | If Installation W/O MP is selected in the site, only "32 Chs +5 dbm/Ch" power is are supported                                       |
| Amplifier Placement  | If Installation W/O MP is selected in the site, C + L band upgradeability is not supported                                           |
| Amplifier Placement  | If Installation W/O MP is selected in the site, OADM output power must cannot be forced.                                             |
| Amplifier Placement  | If Installation W/O MP is selected in the site, node cannot be set as OADM full mux/demux.                                           |
| Dithering Generation | Lower Dithering limit ({0}) cannot be less than {1}                                                                                  |
| Dithering Generation | Upper Dithering limit ({0}) cannot ge greater than {1}                                                                               |
| Dithering Generation | Lower Dithering limit ({0}) cannot exceed Upper Limit ({1})                                                                          |
| Dithering Generation | Site {0} Dithering value cannot be less than Lower Dithering limit {1}                                                               |
| Dithering Generation | Site {0} Dithering value cannot be greater than Upper Dithering limit {1}                                                            |
| Dithering Generation | Sites {0} and {1} cannot have the same Dithering value                                                                               |
| Dithering Generation | Number of available Dithering values {0} cannot be less than number of MultiDegree sites {1}                                         |
| Dithering Generation | Cannot find available Dithering value for site {0}                                                                                   |
| Dithering Generation | Cannot force Dithering value different from 0 in site {0}                                                                            |
| Layout               | MSTP shelves number in site {0} exceeds maximum MultiShelf configuration (8)                                                         |
| Layout               | No linecards placed in Hybrid site {0} optical shelf                                                                                 |
| Layout               | Release 4.7/5.0 does not support MultiShelf                                                                                          |
| Layout               | No PRE/BST card present with OSCM in site {0}                                                                                        |
| Layout               | Layout not feasible for {0} Individual Shelf configuration - No room in the optical shelf to host all the OTS units                  |
| Layout               | No space for DCU: unlock Site {0} layout                                                                                             |
| Layout               | Hybrid Layout in Site {0} is allowed with Individual Shelf only                                                                      |

**Table C-1 Error Messages (continued)**

| Message Type        | Error Message                                                                                                                                                               |
|---------------------|-----------------------------------------------------------------------------------------------------------------------------------------------------------------------------|
| Layout              | Node protection is not allowed in Terminal Site {0}                                                                                                                         |
| Layout              | DCC Chain in Site {0} is allowed with Individual Shelf only                                                                                                                 |
| Layout              | Node protection in Site {0} is not allowed with Individual Shelf                                                                                                            |
| Layout              | Cable DB part not identified in Site {0}                                                                                                                                    |
| Layout              | Site {0} layout must be unlocked to allow Patch Panel/DCU insertion                                                                                                         |
| Layout              | Layout in site {0} cannot be built due an internal error. Other reports for the same site may be wrong or incomplete. Please contact support.                               |
| Layout              | {0} site layout must be unlocked to apply modified properties                                                                                                               |
| Layout              | A/D cards configuration in site {0} is not allowed: please select "Multi Shelf External Switch" or force 32-DMX card                                                        |
| Layout              | Units equipped in site {0} shelf {1} need FTA4. Please replace current fan tray before equipping the units into the shelf                                                   |
| Layout              | Only card Layout position can be changed (Site {0})                                                                                                                         |
| Layout              | Card in Rack {0} - Shelf {1} - Slot {2} cannot be moved to Rack {3} - Shelf {4} - Slot {5} (Site {6})                                                                       |
| Layout              | Just one move is allowed for Card in Rack {0} - Shelf {1} - Slot {2} (Site {3})                                                                                             |
| Layout              | Cards in Rack {0} - Shelf {1} - Slot {2} and Rack {3} - Shelf {4} - Slot {5} (Site {6}) belong to a YCable Protection Group and must be moved to the same destination shelf |
| Layout              | Multidegree topology in site {0} is not supported with Individual Shelf configuration                                                                                       |
| Amplifier algorithm | In {0}, can't force a demux if it is not supported by site type.                                                                                                            |
| Amplifier algorithm | In {0}, can't force an inline attenuator if it is not supported by site type.                                                                                               |
| Amplifier algorithm | In {0}, can't force an inline attenuator because of presence of OADMs in the other side.                                                                                    |
| Amplifier algorithm | Invalid forcing in amplifier node of {0} because of Pass-through site forcing.                                                                                              |
| Amplifier algorithm | In {0}, can't force unplaced OSC card in a non Pass-through site.                                                                                                           |
| Amplifier algorithm | In {0}, can't force OSCM without an amplifier forced.                                                                                                                       |
| Amplifier algorithm | Can't force power output or tilt in {0} without the related amplifier forced.                                                                                               |
| Amplifier algorithm | Cannot force input attenuator in {1} without the related amplifier forced.                                                                                                  |
| Amplifier algorithm | Can't force DCUs in {0} without forcing an amplifier that supports them. See the <a href="#">"C.2.1 Incompatible DCUs (C-Band)"</a> section on page C-17.                   |

**Table C-1** Error Messages (continued)

| Message Type        | Error Message                                                                                                                                                                                            |
|---------------------|----------------------------------------------------------------------------------------------------------------------------------------------------------------------------------------------------------|
| Amplifier algorithm | Incompatible types for DCU couple in {0}. See the <a href="#">“C.2.1 Incompatible DCUs (C-Band)”</a> section on page C-17.                                                                               |
| Amplifier algorithm | Incompatible dispersion modules in {0}. See the <a href="#">“C.2.1 Incompatible DCUs (C-Band)”</a> section on page C-17.                                                                                 |
| Amplifier algorithm | In {0}, MMU presence requires OPT-AMP-L forcing in bst and pre position. See the <a href="#">“C.2.2 MMU Does Not Have Correct Amplifier (L-Band)”</a> section on page C-17.                              |
| Amplifier algorithm | In {0}, MMU presence requires OPT-PRE and OPT-BST-E forcing. See the <a href="#">“C.2.3 MMU Does Not Have Correct Amplifier (C-Band)”</a> section on page C-18.                                          |
| Amplifier algorithm | In {0}, output power is out of limits of amplifier selected. See the <a href="#">“C.2.4 Output Power or Tilt are Out of Range”</a> section on page C-18.                                                 |
| Amplifier algorithm | In {0}, amplifier tilt is out of limits. See the <a href="#">“C.2.4 Output Power or Tilt are Out of Range”</a> section on page C-18.                                                                     |
| Amplifier algorithm | Couple between {1} and {2} has an invalid value in {0}. See the <a href="#">“C.2.5 Invalid Fiber Values, Types, and Loss Values”</a> section on page C-19.                                               |
| Amplifier algorithm | Couple between {0} and {1} is of invalid type. See the <a href="#">“C.2.5 Invalid Fiber Values, Types, and Loss Values”</a> section on page C-19.                                                        |
| Amplifier algorithm | Fibre between {1} and {2} has an invalid value in {0}. See the <a href="#">“C.2.5 Invalid Fiber Values, Types, and Loss Values”</a> section on page C-19.                                                |
| Amplifier algorithm | Fibre between {0} and {1} has SOL total loss greater than EOL total loss. See the <a href="#">“C.2.5 Invalid Fiber Values, Types, and Loss Values”</a> section on page C-19.                             |
| Amplifier algorithm | Can't respect forcing on {0} attenuator (on channel {1}) in {2} {3} {4}. No A/D ports are available. See the <a href="#">“C.2.6 Attenuator Forcing Not Allowed”</a> section on page C-19.                |
| Amplifier algorithm | A {0} attenuator (on channel {1}) in {2} {3} {4} was present, but A/D ports on this channel are no longer available. See the <a href="#">“C.2.7 Unavailable Add/Drop Channels”</a> section on page C-20. |
| Amplifier algorithm | Tilt forced on {0} in {1} {2} {3} when no-tilt design option is selected. See the <a href="#">“C.2.8 Tilt Forced When No Tilt Design is Selected”</a> section on page C-20.                              |
| Amplifier algorithm | Can't change DMX with DMX-O as needed in {1} because user forcing. See the <a href="#">“C.2.9 Cannot Replace 32-DMX with 32DMX-O”</a> section on page C-21.                                              |
| Amplifier algorithm | Low threshold on channels power in {0} {1} {2} because passive user forcing on OPT-BST position.                                                                                                         |
| Amplifier algorithm | In {0}, {1} is working in an invalid mode. See the <a href="#">“C.2.10 Preamplifier Working in Invalid Mode”</a> section on page C-21.                                                                   |

**Table C-1 Error Messages (continued)**

| Message Type        | Error Message                                                                                                                                                               |
|---------------------|-----------------------------------------------------------------------------------------------------------------------------------------------------------------------------|
| Amplifier algorithm | In {0}, {1} is working with a gain of {2} dBm: this is too low. See the <a href="#">“C.2.11 Gain Too Low for an Amplifier”</a> section on page C-22.                        |
| Amplifier algorithm | In {0}, {1} will be work (in EOL condition) with a gain of {2} dBm: this is too low. See the <a href="#">“C.2.11 Gain Too Low for an Amplifier”</a> section on page C-22.   |
| Amplifier algorithm | In {0}, {1} is working with a gain of {2} dBm: this is too high. See the <a href="#">“C.2.12 Gain Too High for an Amplifier”</a> section on page C-22.                      |
| Amplifier algorithm | In {0}, {1} will be work (in EOL condition) with a gain of {2} dBm: this is too high. See the <a href="#">“C.2.12 Gain Too High for an Amplifier”</a> section on page C-22. |
| Amplifier algorithm | In {0}, {1} cannot respect user forcing. See the <a href="#">“C.2.13 User Forcing Overridden”</a> section on page C-23.                                                     |
| Amplifier algorithm | In {0}, {1} cannot respect user forcing due to {2}. See the <a href="#">“C.2.13 User Forcing Overridden”</a> section on page C-23.                                          |
| Amplifier algorithm | Unsupported configuration due to excessive number of amplifiers (max {0} per directions). See the <a href="#">“C.2.14 Unsupported Configuration”</a> section on page C-23.  |
| Amplifier algorithm | Unsupported configuration due to excessive number of OSC regen sites (max {0}). See the <a href="#">“C.2.14 Unsupported Configuration”</a> section on page C-23.            |
| Amplifier algorithm | In {0}, channel power is near the fail threshold. See the <a href="#">“C.2.15 Channel Power Near the Fail Threshold”</a> section on page C-24.                              |
| Amplifier algorithm | In {0}, channel power is below the fail threshold. See the <a href="#">“C.2.16 Channel Power Below the Fail Threshold”</a> section on page C-24.                            |
| Amplifier algorithm | In {0}, OSC channel power is near the fail threshold. See the <a href="#">“C.2.15 Channel Power Near the Fail Threshold”</a> section on page C-24.                          |
| Amplifier algorithm | In {0}, OSC channel power is below the fail threshold. See the <a href="#">“C.2.17 OSC Channel Power Below the Fail Threshold”</a> section on page C-25.                    |
| Amplifier algorithm | Network unfeasible due to OSC channel. See the <a href="#">“C.2.17 OSC Channel Power Below the Fail Threshold”</a> section on page C-25.                                    |
| Amplifier algorithm | Try to unfreeze amplifier or dcus in site {0}, interface {1}, {2} position                                                                                                  |
| Amplifier algorithm | Transmission error. Please contact custom design.                                                                                                                           |
| Amplifier algorithm | Transmission error on channel {0}. Please contact custom design.                                                                                                            |
| Amplifier algorithm | Excessive ROADM crossTalk penalty on channel {0}. Try to lower the output power of the preamplifier in the Roadm site in which the failed channels are added.               |
| Amplifier algorithm | Excessive filtering penalty on channel {0}. Please contact custom design.                                                                                                   |

**Table C-1** Error Messages (continued)

| Message Type        | Error Message                                                                                                                                 |
|---------------------|-----------------------------------------------------------------------------------------------------------------------------------------------|
| Amplifier algorithm | Filtering problem on channel {0}. Please contact custom design.                                                                               |
| Amplifier algorithm | Excessive PMD on channel {0}. Please contact custom design.                                                                                   |
| Layout messages     | MSTP shelves number in site {0} exceeds maximum MultiShelf configuration (12).                                                                |
| Layout messages     | No linecards placed in Hybrid site {0} optical shelf.                                                                                         |
| Layout messages     | Release 4.7/5.0 does not support MultiShelf.                                                                                                  |
| Layout messages     | No PRE/BST card present with OSCM in site {0}.                                                                                                |
| Layout messages     | Layout not feasible for {0} Individual Shelf configuration - No room in the optical shelf to host all the OTS units.                          |
| Layout messages     | No space for DCU: unlock Site {0} layout.                                                                                                     |
| Layout messages     | Hybrid Layout in Site {0} is allowed with Individual Shelf only.                                                                              |
| Layout messages     | Node protection is not allowed in Terminal Site {0}.                                                                                          |
| Layout messages     | DCC Chain in Site {0} is allowed with Individual Shelf only.                                                                                  |
| Layout messages     | Node protection in Site {0} is not allowed with Individual Shelf.                                                                             |
| Layout messages     | Cable DB part not identified in Site {0}.                                                                                                     |
| Layout messages     | Site {0} layout must be unlocked to allow Patch Panel/DCU insertion.                                                                          |
| Layout messages     | Layout in site {0} cannot be built due an internal error. Other reports for the same site may be wrong or incomplete. Please contact support. |

1. Cisco TransportPlanner will replace {n} with a specific unit name.

## C.1 Traffic Mapping Troubleshooting

The following procedures help you resolve traffic mapping problems with the network design.

### C.1.1 Wavelength Exceeded

**Symptom** Cisco TransportPlanner warns you that all network analysis solutions exceed the wavelengths.

[Table C-2](#) describes the potential causes of the symptom and the solution.

**Table C-2**      **Wavelength Exceeded**

| Possible Problem                                                                         | Solution                                                                                                                                                                                                                                                                                                                                                                                                                                                |
|------------------------------------------------------------------------------------------|---------------------------------------------------------------------------------------------------------------------------------------------------------------------------------------------------------------------------------------------------------------------------------------------------------------------------------------------------------------------------------------------------------------------------------------------------------|
| A span in the ring must carry more than 32 wavelengths to implement the traffic demands. | Remove the forced path routing on unprotected channels: <ol style="list-style-type: none"> <li>1. In the Project Explorer under the Service Demands folder, right-click the appropriate demand and choose <b>Edit</b> from the shortcut menu.</li> <li>2. In the Path column, choose <b>Auto</b> from the drop-down list.</li> <li>3. Reanalyze the network.</li> </ol>                                                                                 |
| A span in the ring must carry more than 16/8 wavelengths.                                | Change the traffic mapping design rules under the related subnet and choose an option that allows a greater number of channels: <ol style="list-style-type: none"> <li>1. In the Project Explorer under the Subnets folder, expand Traffic Mapping and click <b>System Release</b>.</li> <li>2. In the Properties pane, choose the new rules option from the C-Band Rules or L-Band Rules drop-down list.</li> <li>3. Reanalyze the network.</li> </ol> |

## C.1.2 Invalid Routing

**Symptom** Cisco TransportPlanner warns you of invalid routing (out of network boundary).

[Table C-3](#) describes the potential causes of the symptom and the solution.

**Table C-3**      **Invalid Routing**

| Possible Problem                                                                                                                              | Solution                                                                                                                                                                                                                                                                                                                                                                              |
|-----------------------------------------------------------------------------------------------------------------------------------------------|---------------------------------------------------------------------------------------------------------------------------------------------------------------------------------------------------------------------------------------------------------------------------------------------------------------------------------------------------------------------------------------|
| In a linear network, the direction of each service demand is restricted by the topology but the user applied an unfeasible direction forcing. | Remove the forced path routing: <ol style="list-style-type: none"> <li>1. In the Project Explorer under the Service Demands folder, right-click the appropriate demand and choose <b>Edit</b> from the shortcut menu.</li> <li>2. In the Path column of the Edit &lt;demand&gt; dialog box, choose <b>Auto</b> from the drop-down list.</li> <li>3. Reanalyze the network.</li> </ol> |

## C.1.3 Cannot Find Alternate Route

**Symptom** Cisco TransportPlanner warns you that it cannot find an alternate route due to multiple hub nodes along the path.

[Table C-4](#) describes the potential causes of the symptom and the solution.

**Table C-4** *Cannot Find Alternate Route*

| Possible Problem                                                                                                                        | Solution                                                                                                                                                                                                                                                                                                                                       |
|-----------------------------------------------------------------------------------------------------------------------------------------|------------------------------------------------------------------------------------------------------------------------------------------------------------------------------------------------------------------------------------------------------------------------------------------------------------------------------------------------|
| Because a hub node does not allow express channels, if multiple hub nodes are present, not all point-to-point connections are possible. | Remove the hub functionality constraints: <ol style="list-style-type: none"> <li>1. In the Project Explorer under the Sites folder, click <b>C-Band</b> or <b>L-Band</b> for the appropriate site.</li> <li>2. In the Properties pane, choose <b>Auto</b> from the Functionality drop-down list.</li> <li>3. Reanalyze the network.</li> </ol> |

## C.1.4 Cannot Route Service

**Symptom** Cisco TransportPlanner warns you that it cannot route service through a hub node.

[Table C-5](#) describes the potential causes of the symptom and the solution.

**Table C-5** *Cannot Route Service*

| Possible Problem                                                                       | Solution                                                                                                                                                                                                                                                                                                                                                                                                                                                                                                                                                                                                                                                                                                                                                                                                             |
|----------------------------------------------------------------------------------------|----------------------------------------------------------------------------------------------------------------------------------------------------------------------------------------------------------------------------------------------------------------------------------------------------------------------------------------------------------------------------------------------------------------------------------------------------------------------------------------------------------------------------------------------------------------------------------------------------------------------------------------------------------------------------------------------------------------------------------------------------------------------------------------------------------------------|
| Since a hub node does not allow express channels, not all service routes are possible. | Remove the path routing forcing or the hub functionality constraints.<br>To remove the path routing forcing: <ol style="list-style-type: none"> <li>1. In the Project Explorer under the Service Demands folder, right-click the appropriate demand and choose <b>Edit</b> from the shortcut menu.</li> <li>2. In the Path column of the Edit &lt;demand&gt; dialog box, choose <b>Auto</b> from the drop-down list.</li> <li>3. Reanalyze the network.</li> </ol> To remove the hub functionality constraints: <ol style="list-style-type: none"> <li>1. In the Project Explorer under the Sites folder, click <b>C-Band</b> or <b>L-Band</b> for the appropriate site.</li> <li>2. In the Properties pane, choose <b>Auto</b> from the Functionality drop-down list.</li> <li>3. Reanalyze the network.</li> </ol> |

## C.1.5 Overlapped Services Assigned to the Same Wavelength

**Symptom** Cisco TransportPlanner warns you that overlapped services are assigned to the same wavelength.

[Table C-6](#) describes the potential causes of the symptom and the solution.



**Table C-6** *Overlapped Services Assigned to the Same Wavelength*

| Possible Problem                                                                           | Solution                                                                                                                                                                                                                                                                                                                                                                                                                                                                                                                                                                                                                                                                                                                                                                                                                                                                              |
|--------------------------------------------------------------------------------------------|---------------------------------------------------------------------------------------------------------------------------------------------------------------------------------------------------------------------------------------------------------------------------------------------------------------------------------------------------------------------------------------------------------------------------------------------------------------------------------------------------------------------------------------------------------------------------------------------------------------------------------------------------------------------------------------------------------------------------------------------------------------------------------------------------------------------------------------------------------------------------------------|
| Some unprotected channels with assigned wavelengths and directions overlap along the ring. | <p>Remove path routing forcing and/or wavelengths on the specific channels.</p> <p>To remove the path routing forcing:</p> <ol style="list-style-type: none"> <li>1. In the Project Explorer under the Service Demands folder, right-click the appropriate demand and choose <b>Edit</b> from the shortcut menu.</li> <li>2. In the Path column of the Edit &lt;demand&gt; dialog box, choose <b>Auto</b> from the drop-down list.</li> <li>3. Reanalyze the network.</li> </ol> <p>To remove the wavelength forcing:</p> <ol style="list-style-type: none"> <li>1. In the Project Explorer under the Service Demands folder, right-click the appropriate demand and choose <b>Edit</b> from the shortcut menu.</li> <li>2. In the Wavelength column of the Edit &lt;demand&gt; dialog box, choose <b>Auto</b> from the drop-down list.</li> <li>3. Reanalyze the network.</li> </ol> |

## C.1.6 Protected Services Assigned to the Same Wavelength

**Symptom** Cisco TransportPlanner warns you that protected services are assigned to the same wavelength.

[Table C-7](#) describes the potential causes of the symptom and the solution.

**Table C-7** *Protected Services Assigned to the Same Wavelength*

| Possible Problem                                                                                                                                                                                            | Solution                                                                                                                                                                                                                                                                                                                                                                                                               |
|-------------------------------------------------------------------------------------------------------------------------------------------------------------------------------------------------------------|------------------------------------------------------------------------------------------------------------------------------------------------------------------------------------------------------------------------------------------------------------------------------------------------------------------------------------------------------------------------------------------------------------------------|
| In ring networks, each protected/P-ring request allocates one wavelength. If more than one protected service is forced on the same wavelength and aggregation is not possible, the network is not feasible. | <p>Remove forced wavelengths on the specific channels:</p> <ol style="list-style-type: none"> <li>1. In the Project Explorer under the Service Demands folder, right-click the appropriate demand and choose <b>Edit</b> from the shortcut menu.</li> <li>2. In the Wavelength column of the Edit &lt;demand&gt; dialog box, choose <b>Auto</b> from the drop-down list.</li> <li>3. Reanalyze the network.</li> </ol> |

## C.1.7 Cannot Route Service Because of Add/Drop Constraints

**Symptom** Cisco TransportPlanner warns you that it cannot route service because of add/drop equipment constraints.

[Table C-8](#) describes the potential causes of the symptom and the solution.

**Table C-8** *Cannot Route Service Because of Add/Drop Constraints*

| Possible Problem                                                                                                 | Solution                                                                                                                                                                                                                                                                                                                                           |
|------------------------------------------------------------------------------------------------------------------|----------------------------------------------------------------------------------------------------------------------------------------------------------------------------------------------------------------------------------------------------------------------------------------------------------------------------------------------------|
| Add/drop equipment forcing might prevent express channels in a node, which makes unfeasible some channel routes. | <p>Remove add/drop equipment constraints.</p> <ol style="list-style-type: none"> <li>1. In the Project Explorer under the Sites folder, click <b>C-Band</b> or <b>L-Band</b> for the appropriate site.</li> <li>2. In the Properties pane, choose <b>Auto</b> from the Functionality drop-down list.</li> <li>3. Reanalyze the network.</li> </ol> |

## C.1.8 Design Requires a ROADM or Full Mux/Demux Site

**Symptom** Cisco TransportPlanner warns you that the design requires a ROADM or full multiplexer/demultiplexer site, but no valid site was found.

[Table C-9](#) describes the potential causes of the symptom and the solution.

**Table C-9** *Cannot Route Service Because of Add/Drop Constraints*

| Possible Problem                                                                                                                                                                                                                                                                                                                                                                                                                                                      | Solution                                                                                                                                                                                                                                                                                                                                                                                                                                                                                                                                                                                                                                                                                                                                                                                                                                                                                                                                                                                                                                                                                                                                                                             |
|-----------------------------------------------------------------------------------------------------------------------------------------------------------------------------------------------------------------------------------------------------------------------------------------------------------------------------------------------------------------------------------------------------------------------------------------------------------------------|--------------------------------------------------------------------------------------------------------------------------------------------------------------------------------------------------------------------------------------------------------------------------------------------------------------------------------------------------------------------------------------------------------------------------------------------------------------------------------------------------------------------------------------------------------------------------------------------------------------------------------------------------------------------------------------------------------------------------------------------------------------------------------------------------------------------------------------------------------------------------------------------------------------------------------------------------------------------------------------------------------------------------------------------------------------------------------------------------------------------------------------------------------------------------------------|
| The traffic mapping algorithm might not be able to find a valid solution that respects both the user forcing and the system specifications (in terms of maximum site losses and layout constraints). In such cases, the only possible countermeasure for the algorithm is to upgrade one node to a full capacity node (ROADM or full Mux/Demux). If no valid node is found due to user forcing or equipment locking, the process stops and the network is unfeasible. | <p>Remove any forcing/locking that prevents at least one node from being upgraded to ROADM or full multiplexer/demultiplexer. Conditions that prevent upgrading a node to ROADM or full multiplexer/demultiplexer are:</p> <ul style="list-style-type: none"> <li>• Site functionality is forced to Add/Drop and site type is forced to OADM</li> <li>• During an upgrade procedure, OADM equipment is locked if the site</li> </ul> <p>To change site functionality and type forcing:</p> <ol style="list-style-type: none"> <li>1. In the Project Explorer under the Sites folder, click <b>C-Band</b> or <b>L-Band</b> for the appropriate site.</li> <li>2. In the Properties pane, choose <b>Auto</b> from the Functionality drop-down list.</li> <li>3. Choose <b>Auto</b> from the Type drop-down list.</li> <li>4. Reanalyze the network.</li> </ol> <p>To unlock OADM equipment:</p> <ol style="list-style-type: none"> <li>1. In the Project Explorer under the Sites folder, click <b>Add/Drop</b> under the appropriate site.</li> <li>2. In the Properties pane, choose <b>Auto</b> from the OADM Forcing drop-down list.</li> <li>3. Reanalyze the network.</li> </ol> |

## C.2 Amplifier Troubleshooting

The following procedures help you resolve amplifier-related problems with the network design.

### C.2.1 Incompatible DCUs (C-Band)

**Symptom** Cisco TransportPlanner warns you that DCUs are incompatible.

[Table C-10](#) describes the potential causes of the symptom and the solution.

**Table C-10** *Incompatible DCUs (C-Band)*

| Possible Problem                                                                                                                                           | Solution                                                                                                                                                                                                                                                                                        |
|------------------------------------------------------------------------------------------------------------------------------------------------------------|-------------------------------------------------------------------------------------------------------------------------------------------------------------------------------------------------------------------------------------------------------------------------------------------------|
| If the DCUs in the same site are both SMF slope compensating, the cumulative negative dispersion should not be over 1600 ps/nm.                            | Remove or change one of the forced DCUs: <ol style="list-style-type: none"> <li>1. In the Project Explorer, click <b>C-Band Amplifiers</b>.</li> <li>2. In the Properties pane, choose the desired DCU from the DCU1 and/or DCU2 drop-down lists.</li> <li>3. Reanalyze the network.</li> </ol> |
| If the DCUs in the same site belong to different types, only the following DCU combinations are allowed: DCU-E-200 and DCU-100, or DCU-E-350, and DCU-100. |                                                                                                                                                                                                                                                                                                 |
| Two E-LEAF slope compensating DCUs are not allowed at the same site.                                                                                       |                                                                                                                                                                                                                                                                                                 |

### C.2.2 MMU Does Not Have Correct Amplifier (L-Band)

**Symptom** Cisco TransportPlanner warns you that an L-band node with an MMU requires that the OPT-AMP-L card is forced as the preamplifier (PRE) and booster amplifier (BST).

[Table C-11](#) describes the potential causes of the symptom and the solution.

**Table C-11** *MMU Does Not Have the Correct Amplifier (L-Band)*

| Possible Problem                                                                                                                   | Solution                                                                                                                                                                                                                                                                                                                       |
|------------------------------------------------------------------------------------------------------------------------------------|--------------------------------------------------------------------------------------------------------------------------------------------------------------------------------------------------------------------------------------------------------------------------------------------------------------------------------|
| In L-band, a node with an MMU installed has amplifier forcing other than two OPT-AMP-L amplifier units, one as PRE and one as BST. | Remove any amplifier forcing in the node: <ol style="list-style-type: none"> <li>In the Project Explorer under the Sites folder, click <b>L-Band Amplifiers</b> for the appropriate site.</li> <li>In the Properties pane, choose <b>Auto</b> from the PRE and BST drop-down lists.</li> <li>Reanalyze the network.</li> </ol> |

## C.2.3 MMU Does Not Have Correct Amplifier (C-Band)

**Symptom** Cisco TransportPlanner warns you that a C-band node with an MMU requires both a preamplifier (OPT-PRE) and a booster (OPT-BST).

[Table C-12](#) describes the potential causes of the symptom and the solution.

**Table C-12** *MMU Does Not Have the Correct Amplifier (C-Band)*

| Possible Problem                                                           | Solution                                                                                                                                                                                                                                                                                                                       |
|----------------------------------------------------------------------------|--------------------------------------------------------------------------------------------------------------------------------------------------------------------------------------------------------------------------------------------------------------------------------------------------------------------------------|
| In C-band, a node with an MMU installed requires both OPT-PRE and OPT-BST. | Remove any amplifier forcing in the node: <ol style="list-style-type: none"> <li>In the Project Explorer under the Sites folder, click <b>C-Band Amplifiers</b> for the appropriate site.</li> <li>In the Properties pane, choose <b>Auto</b> from the PRE and BST drop-down lists.</li> <li>Reanalyze the network.</li> </ol> |

## C.2.4 Output Power or Tilt are Out of Range

**Symptom** Cisco TransportPlanner warns you that the output power or tilt are out of range for the amplifier selected.

[Table C-13](#) describes the potential causes of the symptom and the solution.

**Table C-13** *Output Power or Tilt are Out of Range*

| Possible Problem                                                                                                                                | Solution                                                                                                                                                                                                                                                                                                                                                                                                                                       |
|-------------------------------------------------------------------------------------------------------------------------------------------------|------------------------------------------------------------------------------------------------------------------------------------------------------------------------------------------------------------------------------------------------------------------------------------------------------------------------------------------------------------------------------------------------------------------------------------------------|
| The output power or tilt forced by the user is not within the allowed range based on the algorithm selected and the type of amplifier selected. | Remove or change the forced value: <ol style="list-style-type: none"> <li>In the Project Explorer under the Sites folder, click <b>C-Band Amplifiers</b> or <b>L-Band Amplifiers</b> for the appropriate site.</li> <li>In the Properties pane, choose <b>Auto</b> from the Tilt drop-down list in the From Fibre and To Fibre areas. If you force a value, the tilt value limits are -3.0 to +3.0.</li> <li>Reanalyze the network.</li> </ol> |

## C.2.5 Invalid Fiber Values, Types, and Loss Values

**Symptom** Cisco TransportPlanner warns you of one of the following:

- Fiber pairs are of invalid types or values
- Fibers have a start of life (SOL) total loss greater than an end of life (EOL) total loss

Table C-14 describes the potential causes of the symptom and the solution.

**Table C-14** Invalid Fiber Values, Types, and Loss Values

| Possible Problem                                                      | Solution                                                                                                                                                                                                                                                                                                                                                                                                                                                                                                                                                                                                                                                                                      |
|-----------------------------------------------------------------------|-----------------------------------------------------------------------------------------------------------------------------------------------------------------------------------------------------------------------------------------------------------------------------------------------------------------------------------------------------------------------------------------------------------------------------------------------------------------------------------------------------------------------------------------------------------------------------------------------------------------------------------------------------------------------------------------------|
| An attenuator is forced in a site where there is no place to connect. | <p>Remove the attenuator forcing or verify that the attenuator is inserted on the correct side and wavelength:</p> <ol style="list-style-type: none"> <li>1. In the Project Explorer under the Sites folder, click <b>C-Band Amplifiers</b> or <b>L-Band Amplifiers</b> for the appropriate site.</li> <li>2. In the Properties pane, complete one of the following: <ul style="list-style-type: none"> <li>• Choose <b>Auto</b> from the Attenuator drop-down list in the From Fibre area to remove the forcing.</li> <li>• Verify that the attenuator is inserted on the correct side and wavelength. If not, revise accordingly.</li> </ul> </li> <li>3. Reanalyze the network.</li> </ol> |

## C.2.6 Attenuator Forcing Not Allowed

**Symptom** Cisco TransportPlanner warns you that attenuator forcing on channels is not allowed; no add/drop ports are available.

Table C-15 describes the potential causes of the symptom and the solution.

**Table C-15** Attenuator Forcing Not Allowed

| Possible Problem                                                                              | Solution                                                                                                                                                                                                                                                                                                                                                                                                                                                                                                                                                                                                                                                                       |
|-----------------------------------------------------------------------------------------------|--------------------------------------------------------------------------------------------------------------------------------------------------------------------------------------------------------------------------------------------------------------------------------------------------------------------------------------------------------------------------------------------------------------------------------------------------------------------------------------------------------------------------------------------------------------------------------------------------------------------------------------------------------------------------------|
| Cisco TransportPlanner has an attenuator forced in a site where there is no place to connect. | <p>Remove the attenuator forcing or verify that the attenuator is inserted on the correct side and wavelength:</p> <ol style="list-style-type: none"> <li>1. In the Project Explorer under the Sites folder, click <b>C-Band Amplifiers</b> or <b>L-Band Amplifiers</b> for the appropriate site.</li> <li>2. In the Properties pane, complete one of the following: <ul style="list-style-type: none"> <li>• Choose <b>Auto</b> from the Attenuator drop-down list for the appropriate amplifier.</li> <li>• Verify that the attenuator is inserted on the correct side and wavelength. If not, revise accordingly.</li> </ul> </li> <li>3. Reanalyze the network.</li> </ol> |

## C.2.7 Unavailable Add/Drop Channels

**Symptom** Cisco TransportPlanner warns you that an attenuator was present, but add/drop channels are no longer available.

[Table C-16](#) describes the potential causes of the symptom and the solution.

**Table C-16** *Unavailable Add/Drop Channels*

| Possible Problem                                                                           | Solution                                                                                                                                                                                                                                                                                                                                       |
|--------------------------------------------------------------------------------------------|------------------------------------------------------------------------------------------------------------------------------------------------------------------------------------------------------------------------------------------------------------------------------------------------------------------------------------------------|
| After a network upgrade, a client was removed but the add/drop attenuator is still forced. | Unlock the add/drop attenuator: <ol style="list-style-type: none"> <li>1. In the Project Explorer under the Sites folder, click <b>Client</b> for the appropriate site.</li> <li>2. In the Properties pane, choose <b>Auto</b> from the drop-down list for the appropriate Rx and Tx attenuator.</li> <li>3. Reanalyze the network.</li> </ol> |

## C.2.8 Tilt Forced When No Tilt Design is Selected

**Symptom** Cisco TransportPlanner warns you that tilt is forced for an amplifier although No Tilt Design was selected for the network.

[Table C-17](#) describes the potential causes of the symptom and the solution.

**Table C-17** *Tilt Forced When No Tilt Design is Selected*

| Possible Problem                                                                                                                                                                                                                                                                     | Solution                                                                                                                                                                                                                                                                                                                                                                              |
|--------------------------------------------------------------------------------------------------------------------------------------------------------------------------------------------------------------------------------------------------------------------------------------|---------------------------------------------------------------------------------------------------------------------------------------------------------------------------------------------------------------------------------------------------------------------------------------------------------------------------------------------------------------------------------------|
| The user forced one or more amplifier tilt setting, but the No Tilt Design option is also selected.<br><br><b>Note</b> To view that No Tilt Design is selected in the Project Explorer, click the appropriate system release under DWDM Design Rules settings in the Subnets folder. | Remove forced tilt for the amplifier: <ol style="list-style-type: none"> <li>1. In the Project Explorer under the Sites folder, click <b>C-Band Amplifiers</b> or <b>L-Band Amplifiers</b> for the appropriate site.</li> <li>2. In the Properties pane, choose <b>Auto</b> from the Tilt drop-down list for the appropriate amplifier.</li> <li>3. Reanalyze the network.</li> </ol> |

## C.2.9 Cannot Replace 32-DMX with 32DMX-O

**Symptom** Cisco TransportPlanner warns you that 32-DMX cannot be replaced with 32DMX-O as needed because of user forcing.

Table C-18 describes the potential causes of the symptom and the solution.

**Table C-18** *Cannot Replace 32-DMX with 32DMX-O*

| Possible Problem                                                                                                                                                                                              | Solution                                                                                                                                                                                                                                                                                                                                                                                                                                                                                                                                                                                                                                                                                                                                |
|---------------------------------------------------------------------------------------------------------------------------------------------------------------------------------------------------------------|-----------------------------------------------------------------------------------------------------------------------------------------------------------------------------------------------------------------------------------------------------------------------------------------------------------------------------------------------------------------------------------------------------------------------------------------------------------------------------------------------------------------------------------------------------------------------------------------------------------------------------------------------------------------------------------------------------------------------------------------|
| Cisco TransportPlanner attempts to use the 32DMX-O card but the 32-DMX card is forced by the user. This could cause an overload of alarms or, if no channel is alarmed, problems during network installation. | <p>If channels dropped at the site are alarmed, allow the use of add/drop attenuators:</p> <ol style="list-style-type: none"> <li>1. In the Project Explorer under the Subnets folder, expand DWDM Design Rules and click <b>System Release</b>.</li> <li>2. In the Properties pane, uncheck <b>No TXT/Line-Card RX Bulk Attenuator Design</b>.</li> <li>3. Reanalyze the network.</li> </ol> <p>If no channel is alarmed, remove the 32-DMX forcing:</p> <ol style="list-style-type: none"> <li>1. In the Project Explorer under the Sites folder, click <b>Add/Drop</b> for the appropriate site.</li> <li>2. In the Properties pane, choose <b>Auto</b> from the Demux drop-down list.</li> <li>3. Reanalyze the network.</li> </ol> |

## C.2.10 Preamplicifier Working in Invalid Mode

**Symptom** Cisco TransportPlanner warns you that a preamplifier is working in an invalid mode.

Table C-19 describes the potential causes of the symptom and the solution.

**Table C-19** Preamplifier Working in Invalid Mode

| Possible Problem                                                                                                                                                        | Solution                                                                                                                                                                                                                                                                                                                                                                                                                                                                                                                                                                                                                                                                                                                                                                                                                                                                                                                                                                                                                                                |
|-------------------------------------------------------------------------------------------------------------------------------------------------------------------------|---------------------------------------------------------------------------------------------------------------------------------------------------------------------------------------------------------------------------------------------------------------------------------------------------------------------------------------------------------------------------------------------------------------------------------------------------------------------------------------------------------------------------------------------------------------------------------------------------------------------------------------------------------------------------------------------------------------------------------------------------------------------------------------------------------------------------------------------------------------------------------------------------------------------------------------------------------------------------------------------------------------------------------------------------------|
| A preamplifier is working in power control mode. Based on the traffic matrix, channel survivability might not be guaranteed if the fiber is cut or the equipment fails. | <p>If the booster amplifier preceding the preamplifier is forced as None by the user, remove the None forcing on the booster amplifier:</p> <ol style="list-style-type: none"> <li>1. In the Project Explorer under the Sites folder, click <b>C-Band Amplifiers</b> or <b>L-Band Amplifiers</b> for the appropriate site.</li> <li>2. In the Properties pane, choose <b>Auto</b> from the Tilt drop-down list for the From Fibre (BST) amplifier.</li> <li>3. Reanalyze the network.</li> </ol> <p>If the span preceding the preamplifier is within the 27 to 30 dB range, use a higher powered C- or L-band rules algorithm (such as, 32 Chs + 5 dBm/ch):</p> <ol style="list-style-type: none"> <li>1. In the Project Explorer under the Subnets folder, expand Traffic Mapping and click <b>System Release</b>.</li> <li>2. In the Properties pane, choose the new rules option from the C-Band Rules or L-Band Rules drop-down list.</li> <li>3. Reanalyze the network.</li> </ol> <p>If span is greater than 30 dB, the error is unavoidable.</p> |

## C.2.11 Gain Too Low for an Amplifier

**Symptom** Cisco TransportPlanner warns you that an amplifier is working with a gain that is too low.

[Table C-20](#) describes the potential causes of the symptom and the solution.

**Table C-20** Gain Too Low for an Amplifier

| Possible Problem                                                                                                                                                                                                                   | Solution                                                                                                                                                                                                                                                                                                                                                                                        |
|------------------------------------------------------------------------------------------------------------------------------------------------------------------------------------------------------------------------------------|-------------------------------------------------------------------------------------------------------------------------------------------------------------------------------------------------------------------------------------------------------------------------------------------------------------------------------------------------------------------------------------------------|
| An amplifier is working with a gain lower than its minimum capabilities. This could be caused by a span that is too short or by compensation problems (L-band only) coupled with the “Use in-line attenuator” option not selected. | <p>If attenuators are forced or inline attenuators were disabled, remove the forcing on the attenuators:</p> <ol style="list-style-type: none"> <li>1. In the Project Explorer under the Sites folder, click <b>Add/Drop</b> for the appropriate site.</li> <li>2. In the Properties pane, choose <b>Auto</b> from the Attenuator drop-down list.</li> <li>3. Reanalyze the network.</li> </ol> |

## C.2.12 Gain Too High for an Amplifier

**Symptom** Cisco TransportPlanner warns you that an amplifier is working with a gain that is too high.

[Table C-21](#) describes the potential causes of the symptom and the solution.



**Table C-21** Gain Too High for an Amplifier

| Possible Problem                                                                    | Solution                                                                                                                                                                                                                                                                                                                  |
|-------------------------------------------------------------------------------------|---------------------------------------------------------------------------------------------------------------------------------------------------------------------------------------------------------------------------------------------------------------------------------------------------------------------------|
| An amplifier is working with a gain that is greater than its physical capabilities. | Remove the forcing on the attenuators: <ol style="list-style-type: none"> <li>1. In the Project Explorer under the Sites folder, click <b>Add/Drop</b> for the appropriate site.</li> <li>2. In the Properties pane, choose <b>Auto</b> from the Attenuator drop-down list.</li> <li>3. Reanalyze the network.</li> </ol> |

## C.2.13 User Forcing Overridden

**Symptom** Cisco TransportPlanner warns you that user forcing will not be allowed.



**Note**

This is a warning and does not prevent the network from being fully functional.

[Table C-22](#) describes the potential causes of the symptom and the solution.

**Table C-22** User Forcing Overridden

| Possible Problem                                                                                                                                                                                                                                                 | Solution                                                                                                                                                                       |
|------------------------------------------------------------------------------------------------------------------------------------------------------------------------------------------------------------------------------------------------------------------|--------------------------------------------------------------------------------------------------------------------------------------------------------------------------------|
| If the warning appears during a network upgrade, this means the installation parameters must be updated because the upgrade is traffic affecting. This warning could also appear after importing a Cisco MetroPlanner 2.5.x network with all output as forcings. | For a network upgrade, unlock the site with the warning.<br>For a 2.5.x import, if you cannot update the installation parameters, open the design in Cisco MetroPlanner 2.5.x. |

## C.2.14 Unsupported Configuration

**Symptom** Cisco TransportPlanner warns you that the configuration is unsupported because of an excessive number of amplifiers or OSC regeneration sites.

[Table C-23](#) describes the potential causes of the symptom and the solution.

**Table C-23** *Unsupported Configuration*

| Possible Problem                               | Solution                         |
|------------------------------------------------|----------------------------------|
| The system is working over its specifications. | Revise the design and reanalyze. |

## C.2.15 Channel Power Near the Fail Threshold

**Symptom** Cisco TransportPlanner warns you that the channel power is near the fail threshold.

[Table C-24](#) describes the potential causes of the symptom and the solution.

**Table C-24** *Channel Power Near the Fail Threshold*

| Possible Problem                                                                                                | Solution                                                                                                                                                                                                                                                                                                                                      |
|-----------------------------------------------------------------------------------------------------------------|-----------------------------------------------------------------------------------------------------------------------------------------------------------------------------------------------------------------------------------------------------------------------------------------------------------------------------------------------|
| Some thresholds are set to the minimum value allowed; this could lead to some false alarms during network life. | Remove the forcing: <ol style="list-style-type: none"> <li>1. In the Project Explorer under the Sites folder, click <b>C-Band Amplifiers</b> or <b>L-Band Amplifiers</b> for the appropriate site.</li> <li>2. In the Properties pane, choose <b>Auto</b> from the PRE and BST drop-down lists.</li> <li>3. Reanalyze the network.</li> </ol> |

## C.2.16 Channel Power Below the Fail Threshold

**Symptom** Cisco TransportPlanner warns you that the channel power is below the fail threshold.

[Table C-25](#) describes the potential causes of the symptom and the solution.

**Table C-25**

| Possible Problem                                                                         | Solution                                                                                                                                                                                                                                                                                                                                      |
|------------------------------------------------------------------------------------------|-----------------------------------------------------------------------------------------------------------------------------------------------------------------------------------------------------------------------------------------------------------------------------------------------------------------------------------------------|
| The channel power received by the site is too low, and the fail threshold cannot be set. | Remove the forcing: <ol style="list-style-type: none"> <li>1. In the Project Explorer under the Sites folder, click <b>C-Band Amplifiers</b> or <b>L-Band Amplifiers</b> for the appropriate site.</li> <li>2. In the Properties pane, choose <b>Auto</b> from the PRE and BST drop-down lists.</li> <li>3. Reanalyze the network.</li> </ol> |

## C.2.17 OSC Channel Power Below the Fail Threshold

**Symptom** Cisco TransportPlanner warns you that the OSC channel power is below the fail threshold and that the network is not feasible.

Table C-26 describes the potential causes of the symptom and the solution.

**Table C-26** OSC Channel Power Below the Fail Threshold

| Possible Problem                | Solution                                                                                                                                                                                                                                                                                                                                                                                                             |
|---------------------------------|----------------------------------------------------------------------------------------------------------------------------------------------------------------------------------------------------------------------------------------------------------------------------------------------------------------------------------------------------------------------------------------------------------------------|
| The OSC channel is not working. | Remove the forcing: <ol style="list-style-type: none"> <li>1. In the Project Explorer under the Sites folder, click <b>C-Band Amplifiers</b> or <b>L-Band Amplifiers</b> for the appropriate site.</li> <li>2. In the Properties pane, choose <b>Auto</b> from the OSC drop-down list.</li> <li>3. Reanalyze the network.</li> </ol> If the span where the OSC fails is longer than 37 dB, the error is unavoidable. |





## APPENDIX **D**

# Third-Party DWDM Wavelength Interface Model

---

Cisco TransportPlanner allows you to define a third-party dense wavelength division multiplexing interface to be used in project creation. After you define third-party DWDM interfaces, you can choose them when creating traffic demands. This appendix provides background information for calculating third-party client wavelength interfaces.

## Interface Operative Area

In the Cisco TransportPlanner interface model, the operative area of an interface is defined on a two-dimensional Cartesian plane where the x-axis is the optical signal-to-noise ratio (OSNR) value (dB) and y-axis is the receiver (Rx) power value (dBm). Three lines border the operative area. These lines are an approximation of the ISO-Bit Error Rate (BER) curve corresponding to the maximum BER tolerable by the interface:

- On the original ISO-BER curve there are two points, OL and PL, that define the two main borders: OSNR limited (OL) and power limited (PL).
- The upper boundary of the OSNR-limited border is the interface power overload; this is also the upper limit to the working area. Physical constraints limit this value to 35 to 40 dB.

[Figure D-1](#) shows the working area in an interface.

Figure D-1 Interface Operative Area

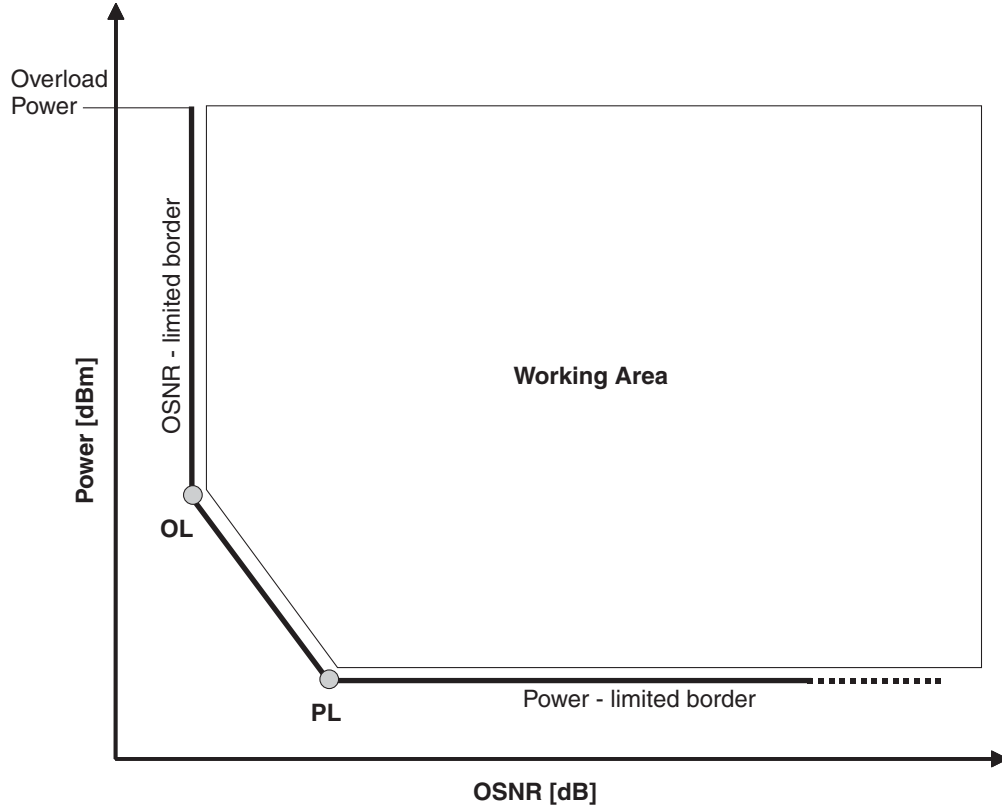

151731

Signal impairments reduce the operative area of the interface. Because of signal distortion, higher OSNR and/or power on the Rx are required to get the same BER. When the power and OSNR margins are increased, OL and PL identify a new working area (Figure D-2).

Figure D-2 Interface Margin Application

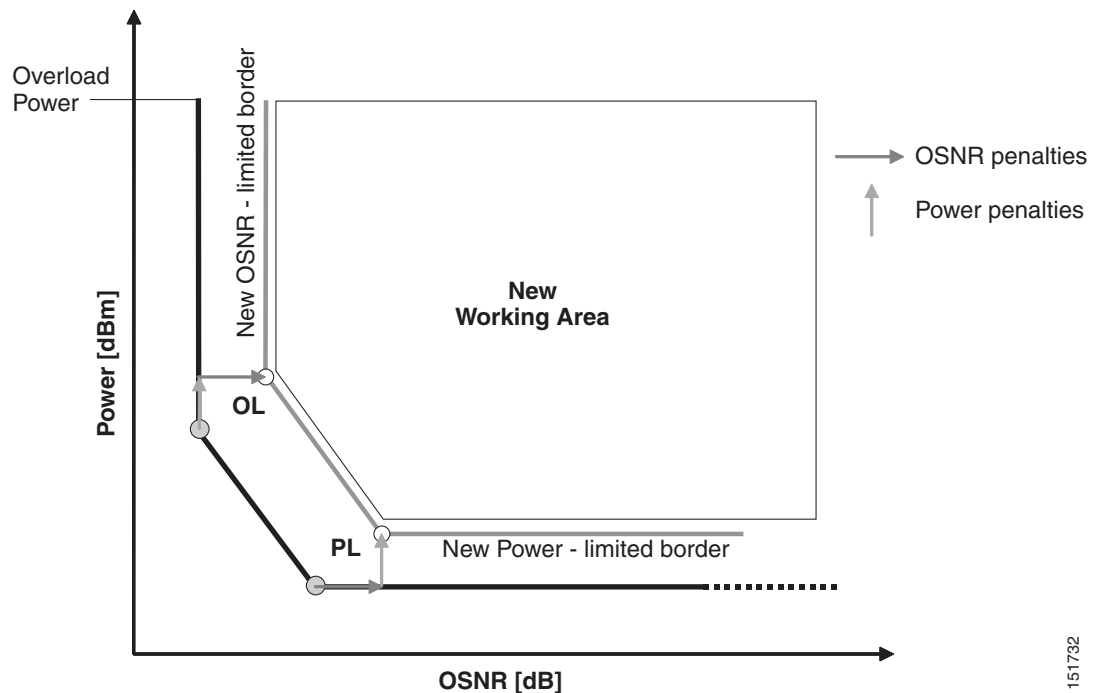

151732

To define a third-party client interface, you enter parameters in Cisco TransportPlanner that build the working area and model its robustness to signal impairments such as dispersion, single interfering, Gaussian cross talk (Xt), etc. The input parameters follow:

- Transmitter characteristics:
  - Modulation format— Non Return to Zero (NRZ) or Duo Binary
  - Transmitter type—Mach Zehnder (MZ), Direct Modulated Laser (DML), or Electro-absorption Modulated Laser (EML)
  - Receiver threshold—Optimal (minimum BER) or Average (average received power)
  - Regeneration type—3R or 2R regeneration mode
  - Forward Error Correction (FEC) mode—FEC, Enhanced FEC (E-FEC), or none
  - Transmitter stability—The maximum wavelength error allowed (pm)
- Bit rate
- Power range—Transmit (Tx) maximum and minimum power output levels (dBm)
- Back-to-back receiver sensitivity—A configuration in which the receiver is placed in front of the transmitter with no other equipment between the two. Back to back is used to measure Tx and Rx pairs.
  - Overload power (dBm)
  - OL\_power (dBm)—The minimum power level in the OSNR-limited range
  - OL\_OSNR (dB)—The minimum OSNR level in the OSNR-limited range (measured on 0.5 nm bandwidth)
  - PL\_power (dBm)—The minimum power level in the power-limited range

- PL\_OSNR (dB)—The minimum power level in the OSNL-limited range (measured in .5 nm increments)
- Chromatic dispersion (CD)—The broadening of a light pulse after traveling a distance in the fiber. You can set the CD robustness [ps/nm], which is the maximum positive dispersion tolerable by the interface.
- Scale value—Calculates how efficient a card is in recovering the signal distortion. For more information, see the “[Scale Factors](#)” section on page D-4.
- Single-interfering cross-talk penalties—Calculates interference caused by a single signal. For more information, see the “[Single-Interfering Cross-Talk Penalty Measurement](#)” section on page D-5.
- Gaussian cross-talk penalties—Calculates random power that interferes with a signal. For more information, see the “[Gaussian Cross-Talk Penalty Measurement](#)” section on page D-6.

Transmitter characteristics, bit rate, and back-to-back sensitivity parameters are required to create a third-party interface; the other parameters are optional. Cisco TransportPlanner checks your input to determine if the third-party interface could be modeled on a card type already present in the software. If the interface is not supported, TransportPlanner displays an error message. For the procedure to define third-party interfaces, see “[2.2.4 Defining Third-Party DWDM Interfaces](#)” section on page 2-25.

## Scale Factors

The slope of the Q-factor (BER error function) curve versus OSNR or Rx power determines how a BER increase could be recovered with an increase of OSNR, power, or both depending in which OSNR/power working point the card is. In general, the scale factors are two values (one in OSNR and one in power) for each working point (OL and PL) of the interface model. If one is zero, it means that for that working point the BER is not sensitive to an increase. At least one factor must be different from zero.

The scale factors reflect the optical signal after it has passed through the maximum dispersion it can tolerate, because when the signal is more distorted the slope is higher and the factors are applied on impairments other than dispersion. As a result, the slope should be calculated at the OSNR and power of the OL and PL points with the dispersion margins added. Q-factor variation is 2 dB.

F-P(PL), F-P(OL), F-OSNR(PL), and F-OSNR(OL) values entered in Cisco TransportPlanner translate a Q-penalty (that is, a BER increase) into power and OSNR penalties. F-P(PL) and F-OSNR(PL) are evaluated in the PL working region, while F-P(OL) and F-OSNR(OL) are evaluated in the OL working region of the curve with the dispersion margins added.

The formulas follow:

- $P\text{-penalty}(PL) = Q\text{-penalty} * F\text{-P}(PL)$
- $P\text{-penalty}(OL) = Q\text{-penalty} * F\text{-P}(OL)$
- $OSNR\text{-penalty}(PL) = Q\text{-penalty} * F\text{-OSNR}(PL)$
- $OSNR\text{-penalty}(OL) = Q\text{-penalty} * F\text{-OSNR}(OL)$

[Figure D-3](#) illustrates the increase in OSNR corresponding to a variation of the Q-factor equal to 2 dB.



Figure D-3 Q-Factor Curve

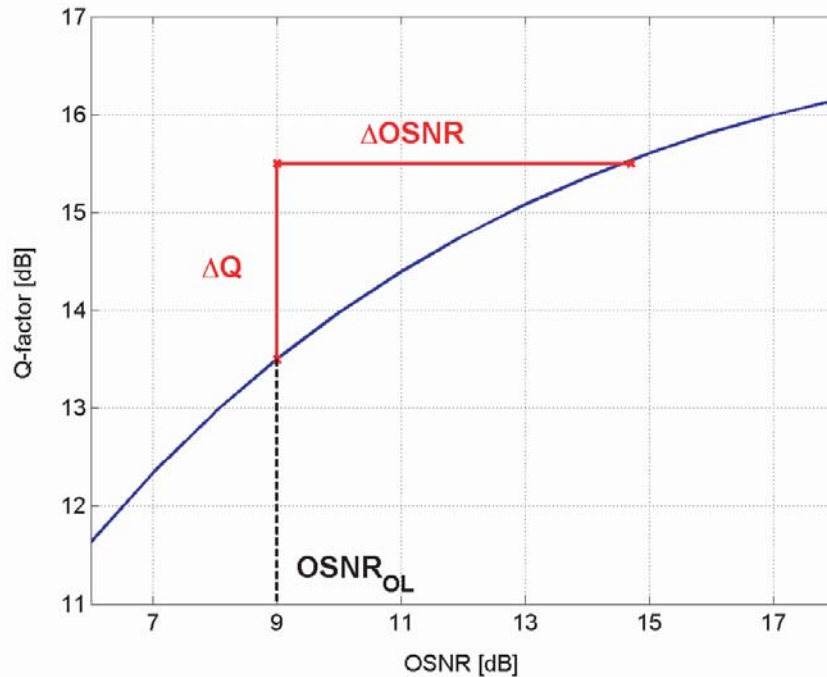

151960

## Single-Interfering Cross-Talk Penalty Measurement

The single interfering cross-talk (Xt) measurement is shown in [Figure D-4](#). The signal is split into two parts and recombined after one part has passed through attenuation, polarization scrambling, and linear transmission. The cross-talk calculation is the ratio between the two recombined signals. The attenuation allows different levels of cross-talk. The polarization scrambling measures the worst case of reciprocal polarization between the signal and its attenuated replica and the fiber to avoid phase coherence between signal and replica.

Because the penalty depends on the OSNR and power level, the measurement is calculated in the two working points OL and PL with the dispersion margin added. Consequently, a fiber with the maximum dispersion the interface can tolerate is placed between the transmitter and the splitter, as shown in [Figure D-5](#). Transmission into the fiber should be linear (with channel power less than  $-10$  dBm).

To calculate single-interfering cross-talk, you can input the coefficients for the exponential curves that estimate P-penalty(PL), P-penalty(OL), OSNR-penalty(PL), and OSNR-penalty(OL) for in the OL and PL regions of the interface model with dispersion margins added. The formula is  $\text{Penalty}(\text{IXt}) = A_{\text{SIXt}} * \exp(B_{\text{SIXt}} * \text{IXt})$ .

Figure D-4 Generation Block for Single-Interfering Cross-Talk Measurement

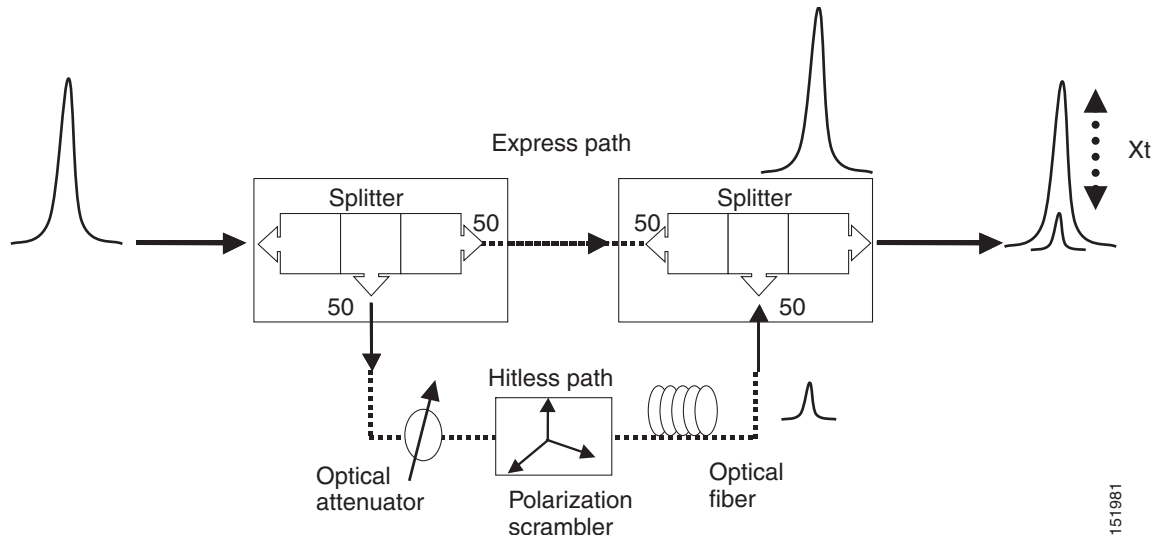
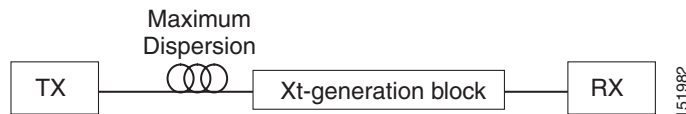

Figure D-5 Block Diagram for Crosstalk Measure



## Gaussian Cross-Talk Penalty Measurement

Cross-talk with Gaussian statistics can be simulated by recombining a high number of interfering signals. The interfering branch shown in Figure D-4 set up has to be replicated in order to obtain more interfering signals, as shown in Figure D-6. The signal is split into  $N$  parts and each part but one passes through an attenuator (from  $A_1$  to  $A_N$  in Figure D-6), a polarization scrambler, and a spool of fiber. Ten interfering signals are enough to guarantee a good approximation of the Gaussian statistics. In case of the single interfering cross-talk, the penalty depends on the working point, OSNR/power, in which the card is working. The measurement should be done in the OL and PL with dispersion margin added with the maximum dispersion tolerable by the card, as shown in the block diagram of Figure D-5.

To calculate Gaussian cross-talk levels, you can enter the coefficients for the exponential curves that estimate P-penalty(PL), P-penalty(OL), OSNR-penalty(PL), and OSNR-penalty(OL) in the OL and PL regions of the interface model with dispersion margins added. The formula is  $\text{Penalty}(\text{GXt}) = A_{\text{GXt}} * \exp(B_{\text{GXt}} * \text{GXt})$ .

Figure D-6 Generation Block for Gaussian Cross-Talk Measurement

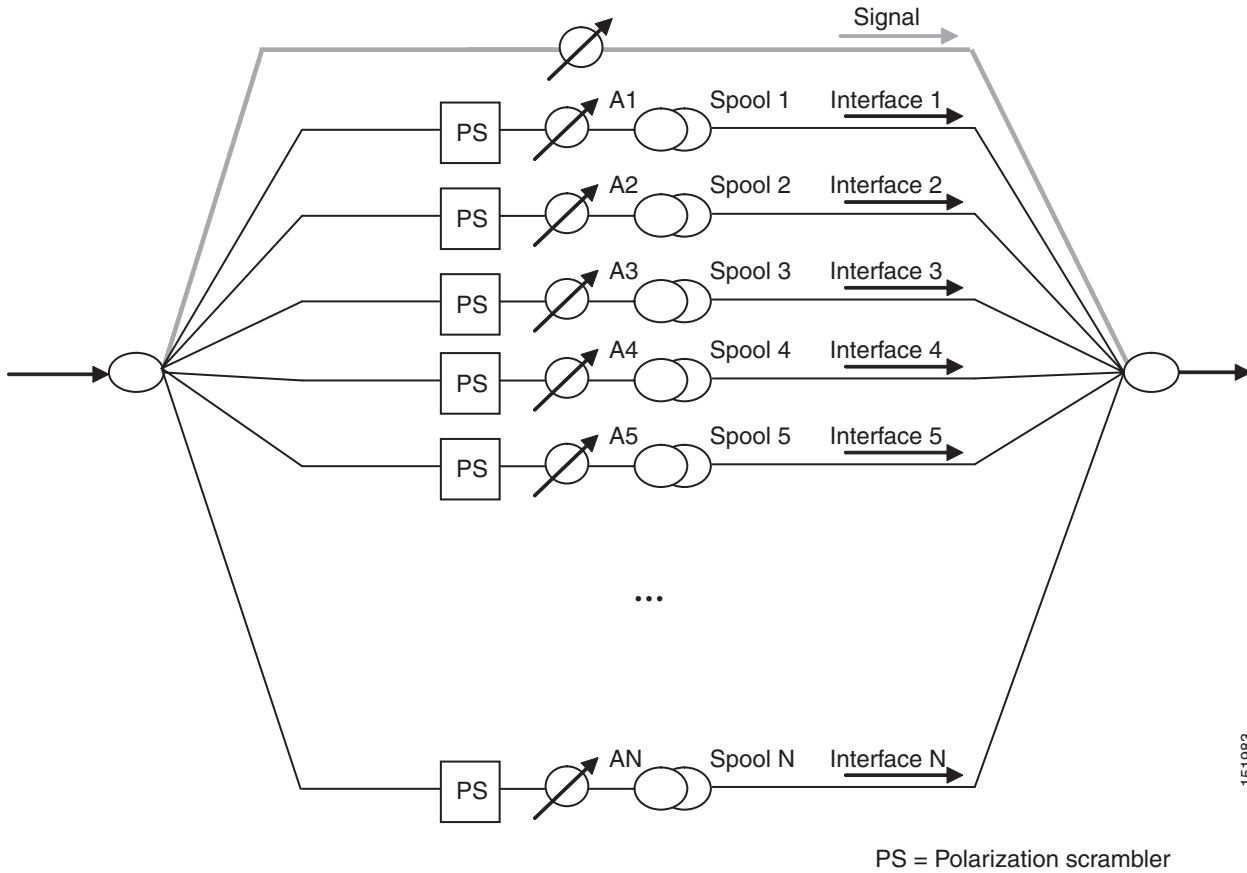

151983





## INDEX

---

### A

#### adding

- fiber spans [2-46](#)
- notes [2-60](#)
- plug-ins [2-33](#)
- sites [2-45](#)
- user profiles [2-35](#)

#### alien interface

- defining [2-25](#)
- Gaussian cross-talk [D-6](#)
- scale factors [D-4](#)
- single-interfering cross-talk [D-5](#)
- working area [D-1](#)

#### Analyzer pane, description [A-7](#)

#### analyzing a network design [2-62](#)

#### any-to-any, description [1-7](#)

#### arranging sites [2-122](#)

---

### B

#### BOM report

- exporting [2-136](#)
- network [2-132](#)
- site [2-133](#)
- spare part [2-134](#)
- totals [2-131](#)

#### bus topologies [3-1](#)

---

### C

#### card descriptions [B-1](#)

#### changing network state

#### install [2-127](#)

#### upgrade [2-128](#)

#### circuit, description [1-7](#)

#### Cisco TransportPlanner

##### GUI description [A-1](#)

##### importing [2-16](#)

#### client-based 1+1 protection, description [1-4](#)

#### client service support [1-4](#)

#### closing a project [2-18](#)

#### color scheme [2-19](#)

#### copy, description [2-126](#)

#### copying price lists [2-140](#)

#### creating

##### Ethernet aggregated demand [2-55](#)

##### maintenance center [2-99](#)

##### network copy [2-127](#)

##### network design JPEG [2-130](#)

##### optical subnet [2-60](#)

##### point-to-point demands [2-48](#)

##### price lists [2-136](#)

##### P-ring demands [2-50](#)

##### projects [2-36](#)

##### ROADM demands [2-53](#)

##### TDM aggregated demand [2-57](#)

##### traffic subnet [2-47](#)

---

### D

#### database file

##### exporting [2-30](#)

##### importing [2-31](#)

#### default layout, resetting [2-32](#)

#### defining a third-party interface [2-25](#)

## deleting

- fiber spans [2-112](#)
- network [2-112](#)
- networks [2-112](#)
- notes [2-112](#)
- price lists [2-140](#)
- sites [2-113](#)
- traffic subnet [2-113](#)

demand, description [1-7](#)

Design-Analyzed state, description [2-126](#)

design state, description [2-126](#)

double ring site arrangement [2-125](#)

downloading Java Runtime Environment [2-13](#)

**E**

## editing

- Ethernet aggregated demand [2-103](#)
- fiber spans [2-114, 2-115](#)
- network parameters [2-91](#)
- point-to-point demand [2-100](#)
- P-ring demand [2-101](#)
- project parameters [2-91](#)
- ROADM demand [2-102](#)
- service demand [2-98](#)
- sites [2-92](#)
- TDM aggregated demand [2-108](#)

ellipse site arrangement [2-123](#)

## Ethernet aggregated demand

- creating [2-55](#)
- editing [2-103](#)

## exporting

- BOM [2-136](#)
- fiber spans [2-122](#)
- files [2-30](#)

**F**

## fiber spans

- adding a span [2-46](#)
- deleting [2-112](#)
- editing [2-114, 2-115](#)
- exporting [2-122](#)

fiber-switched protection, description [1-4](#)

**G**

Gaussian cross-talk [D-6](#)

graphical display, setting [2-18](#)

**H**

hubbed ring topology [3-2](#)

**I**

## importing

- Cisco MetroPlanner Release 2.5 project [2-16](#)
- Cisco TransportPlanner [2-16](#)
- database files [2-31](#)

Install-Analyzed state, description [2-127](#)

Installation Parameters report [2-66](#)

Install state, description [2-126](#)

interface operative area [D-1](#)

Internal Connections report [2-68](#)

**J**

JPEG, network design [2-130](#)

**L**

launching Cisco TransportPlanner [2-14](#)

layout report [2-74](#)

linear topology [3-2](#)

Link Availability report [2-77](#)

loading

network [2-15](#)

price lists [2-139](#)

locked state [2-129](#)

---

## M

maintenance

contracts [2-140](#)

creating a maintenance center [2-99](#)

managing plug-ins [2-34](#)

Maximum Rectangle View [2-125](#)

menu bar and toolbar description [A-2](#)

meshed topology [3-3](#)

modifying

site structure [2-118](#)

mouse shortcuts [A-9](#)

---

## N

network

BOM [2-132](#)

deleting [2-112](#)

editing [2-91](#)

loading [2-15](#)

unloading [2-15](#)

Network Creation wizard [2-38](#)

network design

analyzing [2-62](#)

constraints [1-3](#)

creating a copy [2-127](#)

creating a JPEG [2-130](#)

process flow [1-5](#)

process overview [1-2](#)

putting a network in the Install state [2-127](#)

putting a network in the upgrade state [2-128](#)

state descriptions [2-126](#)

supported client services [1-4](#)

supported platforms [1-3](#)

supported protection schemes [1-4](#)

supported topologies [1-3](#)

unlocking [2-129](#)

Network Mgmt Tree tab

changing the appearance [2-20](#)

NE Update file, saving [2-65](#)

new features [1-1](#)

notes

adding [2-60](#)

deleting [2-112](#)

NtVw Net# tab

changing the appearance [2-19](#)

showing duct details [2-20](#)

---

## O

opening a project [2-15](#)

OPT-AMP-C [1-2](#)

Optical Results report [2-79](#)

optical subnet

creating [2-60](#)

OSNR alarm

regenerating [2-24](#)

---

## P

panes [A-5](#)

penalty [D-6](#)

platform

setting default values [2-20](#)

support [1-3](#)

plug-ins

adding [2-33](#)

managing [2-34](#)

point-to-point demand

- creating [2-48](#)
- deleting [2-113](#)
- description [1-7](#)
- editing [2-100](#)
- viewing in Project Explorer [1-9](#)

point-to-point topology [3-2](#)

power consumption [2-76](#)

PP-MESH [2-84](#)

price lists

- copying [2-140](#)
- creating [2-136](#)
- deleting [2-140](#)
- loading or unloading [2-139](#)
- updating [2-139](#)
- viewing [2-137](#)
- viewing contracts [2-140](#)

P-ring demand

- creating [2-50](#)
- deleting [2-113](#)
- description [1-7](#)
- editing [2-101](#)
- viewing in Project Explorer [1-9](#)

process flow [1-5](#)

project

- adding notes [2-60](#)
- closing [2-18](#)
- creating [2-36](#)
- deleting notes [2-112](#)
- editing parameters [2-91](#)
- importing a Cisco MetroPlanner Release 2.5 project [2-16](#)
- opening [2-15](#)
- saving [2-16](#)
- setting default values [2-24](#)

Project Creation wizard [2-36](#)

Project Explorer

- changing the appearance [2-19](#)
- description [A-6](#)
- loaded network [2-16](#)

- unloaded network [2-16](#)
- view [1-8](#)

Properties pane, description [A-6](#)

protection support [1-4](#)

---

## R

refreshing the Script menu [2-35](#)

regenerating

- OSNR alarm [2-24](#)

release 7.0 to 8.5

- upgrading [2-130](#)

reports

- BOM totals [2-131](#)
- Installation Parameters [2-66](#)
- Internal Connections [2-68](#)
- layout [2-74](#)
- Layout Table (power consumption) [2-76](#)
- Link Availability [2-77](#)
- network BOM [2-132](#)
- Optical Results [2-79](#)
- site BOM [2-133](#)
- spare part BOM [2-134](#)
- Summary [2-63](#)
- Traffic Matrix [2-70](#)
- Wavelength Routing [2-83](#)

resetting the default layout [2-32](#)

restricted equipment list, updating [2-22](#)

ROADM demand

- creating [2-53](#)
- deleting [2-113](#)
- description [1-7](#)
- editing [2-102](#)
- routing strategies [1-7](#)
- viewing in Project Explorer [1-9](#)

rules, C-band [2-21, 2-23](#)

running a script [2-35](#)



---

**S**

## saving

- NE Update file [2-65](#)

- project [2-16](#)

scale factors [D-4](#)scripts, refreshing directories [2-35](#)scripts, running [2-35](#)

## service demand

- editing [2-98](#)

## setting

- graphical display [2-18](#)

- platform default values [2-20](#)

- project default values [2-24](#)

shortcuts [A-9](#)Sides Label [2-36](#)single-interfering cross-talk [D-5](#)single-span topology [3-1](#)site layout, adjusting [2-120](#)

## sites

- adding a site [2-45](#)

- arranging [2-122](#)

- BOM [2-133](#)

- creating a maintenance center [2-99](#)

- deleting [2-113](#)

- deleting a site [2-113](#)

- editing [2-92](#)

## site structure

- modifying [2-118](#)

snake site arrangement [2-124](#)snapshot, network design [2-130](#)spare part BOM [2-134](#)spare parts suppliers [2-99](#)square site arrangement [2-123](#)Summary report [2-63](#)

---

**T**

## tasks pane

- description [A-8](#)

- open command [2-15](#)

## TDM aggregated demand

- creating [2-57](#)

- editing [2-108](#)

## third-party interface

- defining [2-25](#)

- Gaussian cross-talk [D-6](#)

- scale factors [D-4](#)

- single-interfering cross-talk [D-5](#)

- working area [D-1](#)

topologies [3-1](#)

- bus [3-1](#)

- hubbed ring [3-2](#)

- linear [3-2](#)

- meshed [3-3](#)

- point-to-point [3-2](#)

- single-span [3-1](#)

topology support [1-3](#)

## traffic

- viewing [1-8](#)

## traffic groups

- description [1-7](#)

- point-to-point [1-9](#)

- P-ring [1-9](#)

- ROADM [1-9](#)

Traffic Matrix report [2-70](#)

## traffic subnet

- creating [2-47](#)

- deleting [2-113](#)

---

**U**

## unloading

- network [2-15](#)

- price lists [2-139](#)

unlocking network components [2-129](#)unprotected minimum hop count, description [1-8](#)unprotected optimum optical path, description [1-8](#)

unprotected subnet, description [1-8](#)

updating

price lists [2-139](#)

restricted equipment list [2-22](#)

Upgrade-Analyzed state, description [2-127](#)

Upgrade state, description [2-127](#)

upgrading

release 7.0 to 8.5 [2-130](#)

user profiles, adding [2-35](#)

---

## V

viewing

maintenance contracts [2-140](#)

price lists [2-137](#)

traffic [1-8](#)

---

## W

Wavelength Routing report [2-83](#)

---

## Y

Y-cable protection, description [1-4](#)